

2020

2020

MULTI V™

**LG AIR
SOLUTION**



MULTI V™

LG Electronics

<http://www.lg.com>
<http://partner.lge.com>

Copyright © 2020 LG Electronics. All rights reserved.

Distributed by





022 - 101
**OUTDOOR
UNITS**

MULTI V S	024
MULTI V S	052
MULTI V M	070
MULTI V WATER IV (HEAT PUMP / HEAT RECOVERY)	078



102 - 163
**INDOOR
UNITS**

WALL MOUNTED	104
CEILING MOUNTED CASSETTE	114
CEILING MOUNTED ROUND CASSETTE	132
CEILING CONCEALED DUCT	136
FRESH AIR INTAKE	148
CEILING & FLOOR CONVERTIBLE CEILING SUSPENDED	150
CONSOLE & FLOOR STANDING	154
COMPATIBILITY	160
FEATURE FUNCTIONS	163



164 - 169
**HOT WATER
SOLUTION**

HYDRO KIT	166
-----------	-----



170 - 179
**VENTILATION
SOLUTIONS**

ERV	172
ERV WITH DX COIL	178

180 - 235
**CONTROL
SOLUTIONS**

INDIVIDUAL CONTROL	184
CENTRALIZED CONTROL	192
INTEGRATION DEVICE	204



236 - 257
ACCESSORIES

MECHANICAL ACCESSORIES	238
PIPING ACCESSORIES	246

10 ADVANTAGES OF MULTI V

1 ULTIMATE EFFICIENCY

Ultimate Energy Saving with Dual Sensing Control.

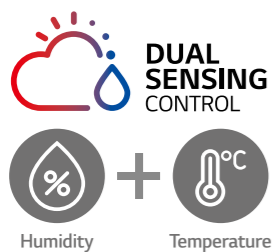

2 INNOVATIVE TECHNOLOGIES

Ultimate Inverter Compressor
- **MULTI V S**
Revolutionary Scroll R1 Compressor
- **MULTI V S R32, MULTI V M**



3 SUPERIOR DURABILITY

LG's exclusive "Ocean Black Fin" heat exchanger is designed to perform even in corrosive Environments.

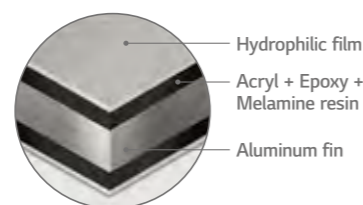

Certified protection



※ Verification of corrosion resistance performance
- Declared by TUV Rheinland
- Test Method B of ISO21207
- Test condition : Salt contaminated condition + severe industrial/traffic environment(NO2/SO2)

4 DESIGN FLEXIBILITY

Flexible Installation with Large Capacity Outdoor Unit.

MULTI V 5 enables easy type change-over to suit the purpose of any building.

MULTI V S allows versatile design with flexible piping locations.

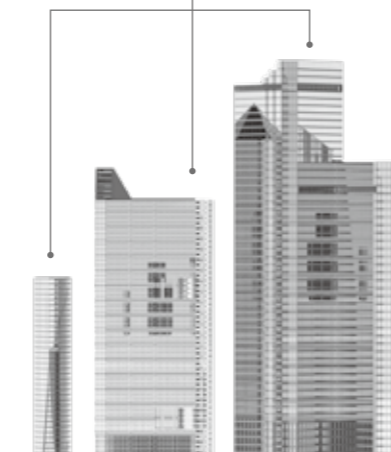

5 SMART CONTROLS

MULTI V responds to diverse building environments with LG ThinQ-based AI control and individual/central integrated control solutions.

LG ThinQ™



6 BUSINESS SUPPORT

- Engineering Tools & Support
- LG Air Conditioning Academy
- European LG Energy Lab
- European Air Conditioning Distribution Center

7 DIVERSE PRODUCT LINEUP

LG offers a specialized product lineup suited for various business environments, perfectly responding to the unique conditions no matter the use case.

9 R32 APPLICATION

New line-up applying the industry-first mini VRF with R32 refrigerant to MULTI V S.



8 DIVERSE INTEGRATED SOLUTION

Integrated solution optimized for various business environments, including hot water, AHU, BMS, and EMS.

10 BRAND RELIABILITY

Global production sites facilitate world-class customer service.

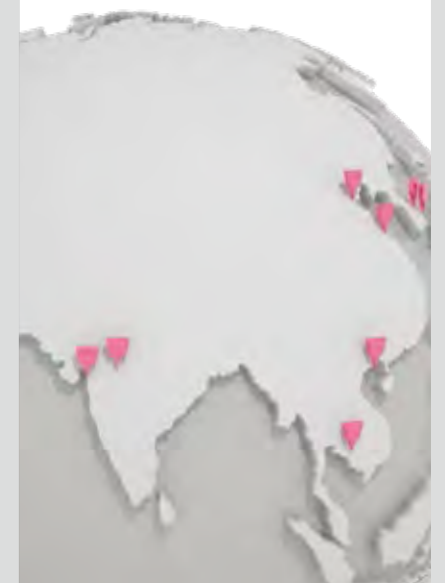

MULTI V BRAND HISTORY

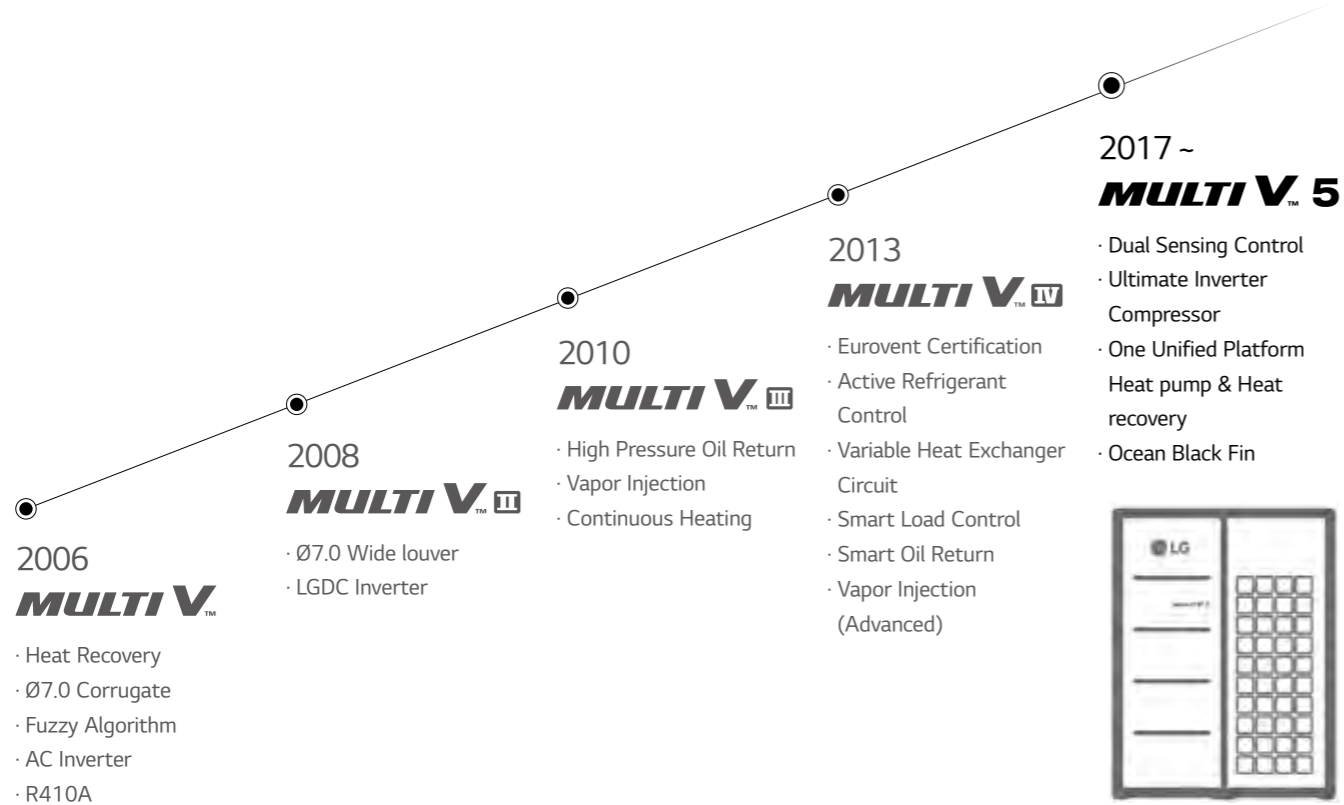

Since the time when LG launched Korea's first residential air conditioner in 1968, the company has worked to continuously enhance its technological innovation and reliability. As a result of sustained improvement, LG VRF launched the first generation of MULTI V in 2006 and achieved significant development. With the best-in-class compressor technology and innovation applied to every part and control solution, MULTI V has evolved to be on of the world's most efficient and reliable VRF solutions.

The first and second generations of MULTI V boasted inverter technology and non-ozone depleting technology, while MULTI V III was produced with cutting edge tech like oil return with HiPOR™ and double compression features with mid-pressure refrigerant allowed by Vapor Injection. The innovative technologies of MULTI V's fourth generation brought about product leadership in efficiency. Its smart load control adjusts with the outdoor temperature, while optimizing refrigeration management and heat exchange for both cooling and heating.

MULTI V's wide range of VRF solutions satisfies various building types and sizes. MULTI V S's size discharge was designed for small to mid-sized buildings while MULTI V Water is a water-cooled VRF solution with variable water flow control technology.

In 2017, the ultimate VRF solution was introduced with MULTI V 5. This generation has fully improved its technological potential with the powerful and reliable yet economical Ultimate Inverter Compressor, effective corrosion resistance with the Ocean Black Fin coating and enlarged fans. Dual Sensing Control offers the most pleasant indoor environment while minimizing unnecessary energy loss by sensing both temperature and humidity to efficiently manage cooling, heating and part load.

MULTI V 5 has been designed for the ultimate efficiency, performance, flexibility, comfort and control, ensuring the most pleasant indoor experience.

INFRASTRUCTURE IN EUROPE





LG Air Conditioning Academy

LG has set up 20 official air conditioning academies in Europe, teaching much needed skills to thousands of current industry professionals including installers, consultants, designers, sales staff and service technicians. The academy program is being used to share expertise and educate these HVAC experts by providing a cutting-edge technical experience with the newest and most advanced technologies and equipment. Moreover, as LG's entire product range is installed on site, professionals can be trained in a realistic way that offers them the chance to experience the latest products first-hand.



European Air Conditioning Distribution Center

LG's European Air Conditioning Distribution Center is located in Oosterhout, the Netherlands. Supplying and delivering products all over Europe, this distribution hub has contributed to smooth and rapid delivery, direct shipping for smaller orders and delivery tailored to air conditioners. The hub tries to manage inventory efficiency by taking advantage of LG EU's established inventory pool.

-  Air Conditioning Academy
-  Europe Energy Lab
-  European Distribution Center

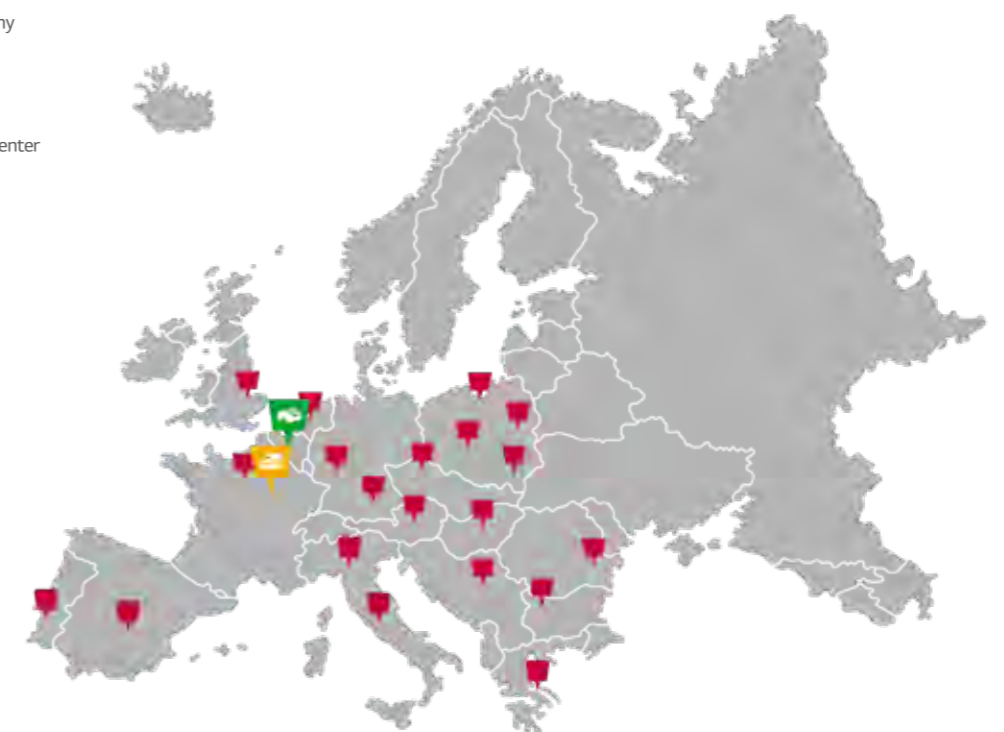

ENGINEERING TOOLS & SUPPORT

From planning to service & maintenance and then to de-construction, an architectural project goes through many stages from the beginning to the end of its lifecycle. Along those stages, various engineering tools are applied to solve the diverse issues happening in each stage, with the most optimal solution possible. Given the usage of such tools, buildings are effectively designed, built, supervised, and maintained throughout their lifecycle.

Dedicated to provide the best HVAC engineering support, LG Electronics Air Solution Business Unit offers several engineering tools and solutions focused on HVAC, during the overall lifecycle of a building, related to the three categories. Among them, the LATS* Program series has been developed to offer the best tool for LG HVAC systems, providing our customers with a solution that allows for faster, easier and more accurate model selection, draft energy estimations and more.

* LATS : LG Air-conditioner Technical Solution



I

**Energy Estimation
& Energy Modeling**



II

**Model Selection
& Design**



III

**Installation
Environment
Simulation**

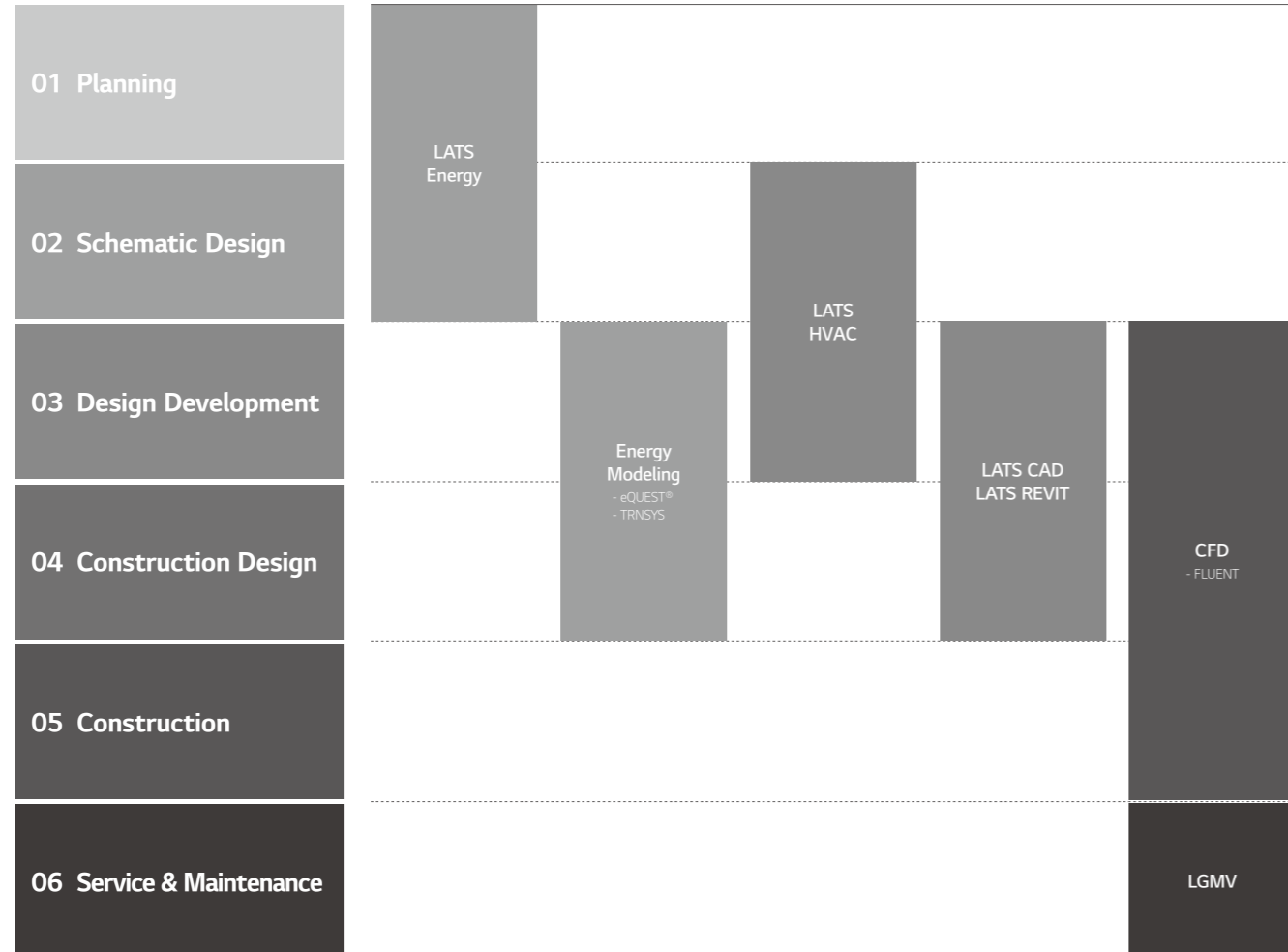

01 Draft Energy Estimation

LATS Energy

LATS Energy is a program developed by LG to estimate energy consumption and analyze the life cycle cost of LG commercial air conditioning systems during a project's early stages.



02 Building Energy Modeling

eQuest, EnergyPro, Trace700 and More

These are certified commercial programs which assess the HVAC system efficiency and building's annual energy savings for building standards or certifications, like LEED. LG HQ supports these programs for the project stages of Design Development and Construction Design wherein the overall designing is finished.

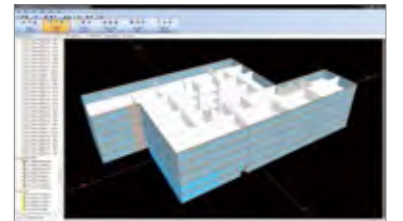

03 Model Selection

LATS HVAC

LATS HVAC is a model selection program that accurately and quickly selects the most suitable LG commercial air conditioning systems for each design. In addition to model selection, faster estimation on refrigerant piping diameter and additional refrigerant is possible, along with auto printing of reports.

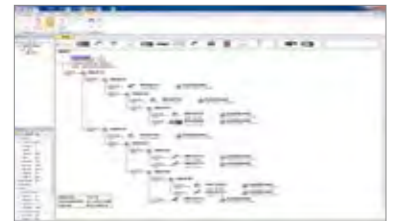

04 Design

LATS CAD

LATS CAD enables faster and more accurate 2D design of LG commercial air conditioning systems. It also enables modules for quotation and installation review that minimize inherent problems during installation and commissioning.

※ AutoCAD program is required.

LATS REVIT

LATS REVIT allows BIM users to have an attractive 3D design of LG commercial air conditioning systems with embedded calculations for refrigerant and efficiency features.

※ AutoCAD Revit program is required.



05 Environment Simulation

CFD Analysis

CFD Analysis is applied in areas of estimating : indoor airflow and temperature distribution while operating VRF products, outdoor airflow distribution, and noise level. By running a simulation before construction, engineers estimate possible issues and find optimal solutions for malfunctions that could occur after construction.



06 Service & Maintenance

LGMV

LGMV offers real-time MULTI V cycle monitoring. During start-up, LGMV can check for normal operation as well as troubleshoot any errors. Also it helps to find causes of errors and solve the problem faster.



BENEFITS OF LG MULTI V

Benefits for Building Owners



Efficient Management & Cost Reduction

- Fault Detection Diagnosis enables easy maintenance
- Requires no extra manpower for regular maintenance
- With diverse control systems, maintenance cost is minimized



Reliability at Every Stage

- Ultimate Inverter Compressor developed and manufactured in Korea
- Corrosion resistant Ocean Black Fin for harsh conditions operation
- Smart Oil management (Auto Oil Balancing and Active Oil return) decreases compressor damage



Customized Comfort and Solution

- Compatible option between Heat pump and Heat recovery system is possible



Benefits for Developers & Construction Companies



Green Solutions

- Optimized for LEED/BREEAM certification
- Renewable energy solution provided through geothermal application



Maximizing Space Utilization

- Large capacity in compact size enhances space utilization



Smart Building Solutions

- Seamless integration with current Building Management Systems
- Wi-Fi control available for anytime, anywhere access (via the 'LG ThinQ' mobile app)
- Energy management and control according to usage and planning is possible with LG's centralized control solution



Benefits for Consultants



Versatile Solutions

- Air-cooled, Water-cooled, Heating, and Air Handling Unit interlocking solutions



Professional Design Support

- LATS (LG Air-conditioner Technical Solution) for draft energy estimation, model selection, HVAC design and 3D designing
- CFD Analysis to ensure suitable solutions and prevent malfunctions
- Energy simulation offered to find the optimal solution



Optimized Convenience with HVAC Design

- Flexible and longer piping length facilitates HVAC designing process
- Meets any type of customer requirements of diverse environment, design conditions, and building applications



Benefits for End-users



Cost Saving Operation

- High efficiency guaranteed throughout product line-up
- Up to 31% cost savings with MULTI V's Smart Load Control*



Comfort Cooling & Heating

- Smart Load Control maximizes indoor comfort level
- Dual Sensing Control offers pleasant and comfortable cooling and heating environment
- Duration time of Continuous Heating is 11% longer than previous model**



Convenient Functions

- Low-noise operation provides a pleasant environment

* Dual Smart Load Control ESEER based, below 50% humidity, model ARUM260LTE5
 ** LG internal test result



APPLICATION SOLUTIONS

Office

Supporting efficiency with flexibility

High Rise Office Building



- MULTI V WATER IV
- DX AHU
- High Static Duct
- PDI**
- Variable water flow control kit

Small to Medium sized Office Building



- MULTI V 5 / S
- 4 Way CST*
- PDI**

The MULTI V series revitalizes the workspace by providing fresh air at all times. LG's intelligent control solutions add comfort to any space.

Commercial

Maximizing business, minimizing cost

Shopping Mall



- MULTI V 5
- DX AHU

Retail



- MULTI V M
- ERV
- Convertible

Quick Service Restaurant (QSR)



- MULTI V M
- ERV
- Hydro Kit
- 4 Way CST

The highly efficient, energy saving MULTI V 5 and MULTI V M reduces operation costs, and provides comfort that suits any purpose and any space, helping to invest the extra space and expense to your business.

* CST : Cassette ** PDI : Power Distribution Indicator

Residential

Creating a comfortable home

Condominium & Apartments



- MULTI V S HR
- Hydro Kit
- 1/2 Way CST
- 3rd party controller RTU gateway

Single Family House & Villa



- MULTI V S
- Therma V
- ESS* & PV** Solar

Remarkably compact size and high static pressure of MULTI V S enables optimal space solution, providing comfort to every space through individual zone control and hot water solution.

Hospitality

Meeting diverse needs

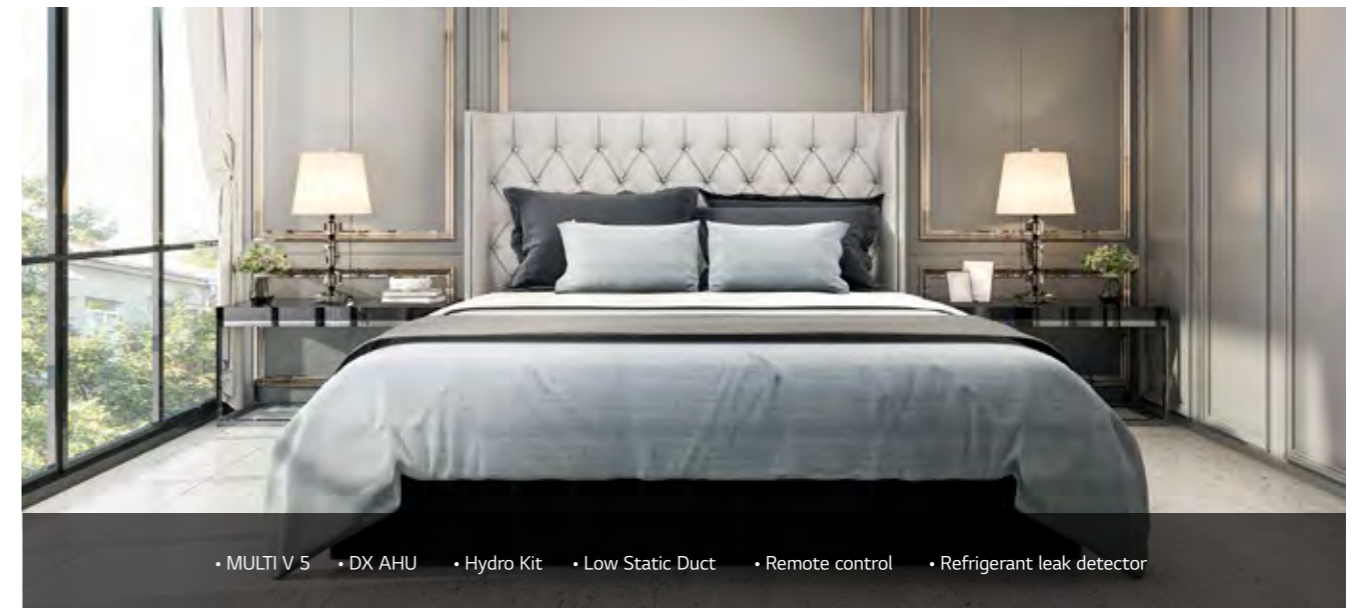

- MULTI V 5
- DX AHU
- Hydro Kit
- Low Static Duct
- Remote control
- Refrigerant leak detector

The diverse applications that can be applied to MULTI V 5 helps bring just the right solution to a sophisticated hotel business.

* ESS : Energy Storage System ** PV : Photovoltaics

DIVERSE INTEGRATED SOLUTION

Hot Water Solution

Water heating costs can be reduced with a heat pump, which provides higher efficiency than a boiler system. The Hydro Kit can be connected to MULTI V 5, providing temperatures up to 80C. Energy savings can be maximized with the combination of the Hydro Kit and the MULTI V 5 Heat Recovery system.

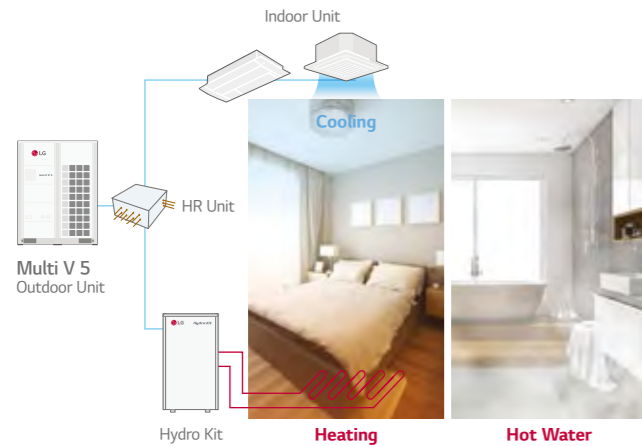

Air Handling Unit (AHU) Solution

AHU is a suitable solution for cooling and heating in large space. With an LG AHU Comm. Kit (for both return air / supply air control) connected to the DX coil of the AHU, LG VRF system can be applied to deliver conditioned air.

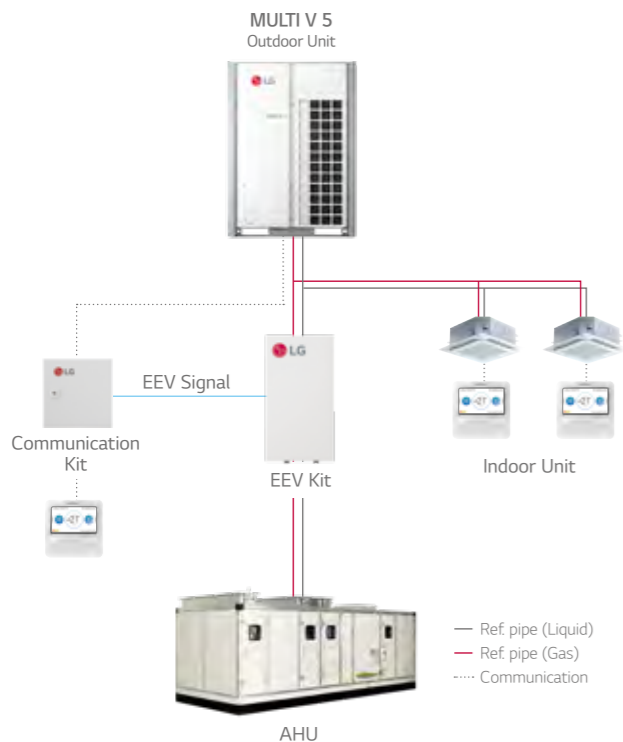

Refrigerant Leak Detection Solution

Real-time refrigerant leak detection ensures a safe environment. When refrigerant concentration exceeds 6,000ppm for 5 seconds, the indoor unit will stop operation and alert users with a buzzer or light switch (Dry contact option).

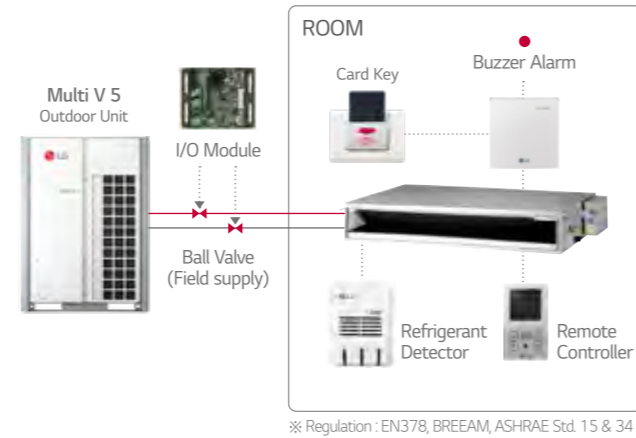

Power Consumption Distribution Solution

In case of shared power consumption in a building, a solution to distribute the power consumption amount per tenant might be necessary. Electricity charges can be billed to each tenant by using output from the LG Power Distributor Indicator (PDI). An administrator is able to check the power usage for each space and date as needed. If the PDI is used in conjunction with an LG central controller, the results can be exported to Excel.

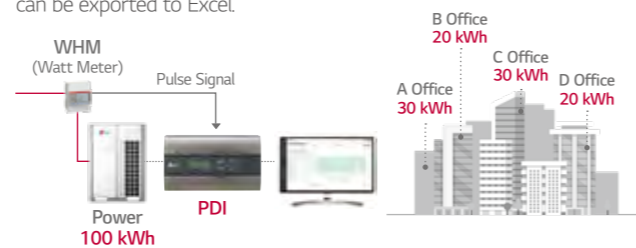

Total Control of Any Device

In order to manage multiple spaces and multiple buildings, the administrators should be able to control systems from wherever they are. The LG central controller can be controlled from any web browser that supports HTML5. Now through the implementation of HTML5, the interface will look great and perform well on any device.

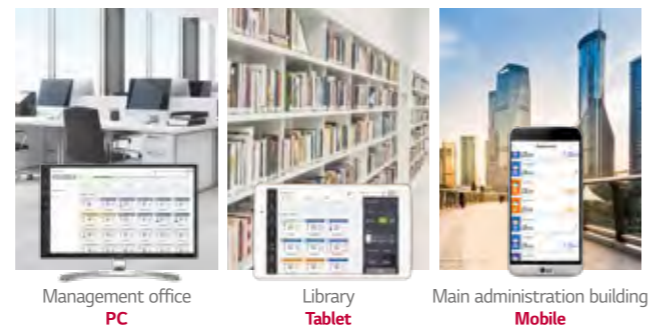

DIVERSE INTEGRATED SOLUTION

Energy Management Solution

Since HVAC systems use a significant portion of any building's total amount of energy, the energy saving functions of a controller can make a big difference. The energy navigation function enables you to set target values for energy consumption over a certain period of time. In addition, to achieve that value, the administrator can set the energy saving logic in 7 steps and predict the expected usage relative to the target value. Active self-management enables energy savings through out the building.



Integration Solution with BMS

There are many BMS protocols used for the control of buildings' various systems such as HVAC, lighting, power and security. LG has a wide range of gateway products for different protocols such as BACnet, Modbus, and LonWorks. In addition, LG gateways include Stand-alone central control capability to act as a back-up controller of the BMS if needed.

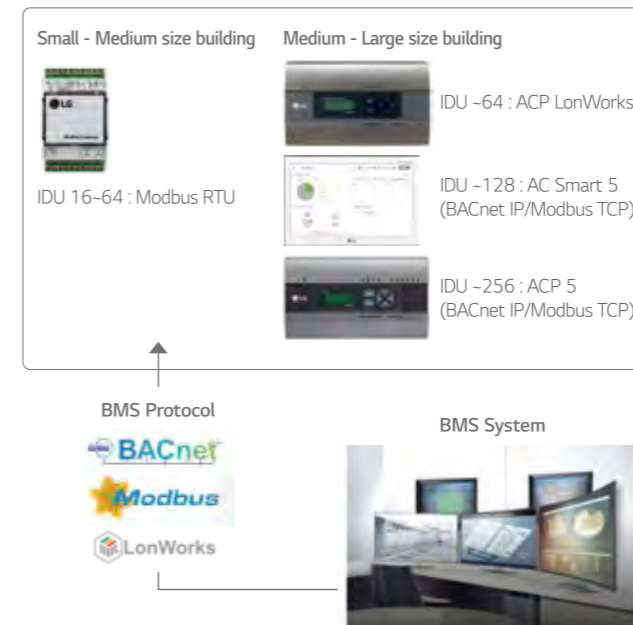

Interlocking Solution by Using ACU Module

It is costly to introduce a BMS system to control multiple devices or systems in a small building. With the ACU module, various IO contact points (DI, DO, UI, AO) can be interlocked and integrated, while control is possible from the LG central controller. This enables an efficient management of lighting, pumps and other devices in the building in conjunction with the HVAC system.



Interlocking Solution Using Dry Contact

3rd party thermostats can be used to control LG air conditioners in a room by using a multi point dry contact. The dry contact enables basic control of air conditioners as well as making it possible to report the status and any errors impacting the indoor unit.

The Standard III remote control has a DO port. With this DO port, it is possible to interlock the indoor unit with 3rd party devices such as lighting, a fan, or a radiator, based on things like operation mode or current temperature.

The indoor unit can be interlocked with various types of input such as card key-tag, door sensor, human detection sensor etc. so that the air conditioner is automatically operated. In addition, the dry contact option settings enable operation of air conditioner to maintain proper temperature when the occupant is absent. This solution makes sure that the room does not overheat or become too cold when unoccupied so that energy cost can be saved.



OUTDOOR UNITS LINE-UP

Unit : HP
 ● 380V, 3Ø ○ 220V, 1Ø

Features	Appearance	4	5	6	8	10	12	14	16	18	20			
MULTI V™ 5 • Dual Sensing Control • Large capacity ODU (Up to 26HP) • Continuous Heating • Ocean Black Fin heat exchanger • Heat pump or heat recovery function • Flexible installation with heat recovery unit and large capacity • For large space, high rise building and individual control building					●	●	●							
								●	●	●	●			
MULTI V™ S • Space saving • Flexible design applications - Slim, light, and broad range (4 - 12 HP) - Large number of connectable indoor units (Up to 20 Units) • For small / medium building		○	○											
		●	○	○	○									
					●	●	●							
MULTI V™ S Heat Recovery				○										
MULTI V™ S R32		○	○	○										
MULTI V™ M • High flexibility of installation • Quiet operation • Various indoor unit combinations & long distance between modules			●											
MULTI V™ WATER IV Heat Pump / Heat Recovery • High efficiency system regardless external conditions • Indoor installation • Low noise operation (No fan) • For water-sourced system, high rise building and building with aesthetic requirements. • Simultaneous cooling and heating • Minimized energy cost by water sourced heat recovery system • For individual control building					●	●		●			●			
									●	●				
									●	●	●			
											●	●	●	

22	24	26	28	30	32	34	36	38	40	42	44	46	48	50	52	54	56	58	60	62	64	66	68	70	72	74	76	78	80	...	96		
●	●	●																															
●	●	●	●	●	●	●	●	●	●	●	●	●	●																				
														●	●	●	●	●	●	●	●	●	●	●	●								
																										●	●	●	●	●			

INDOOR UNITS LINE-UP

kW			1.5	2.2	2.8	3.6	4.5	5.6	6.2	7.1	8.2	9.0	10.6	12.3	14.1	15.8	22.4	28.0	
Type	Btu/h	Type																	
		5k	7k	9k	12k	15k	18k	21k	24k	28k	30k	36k	42k	48k	54k	76k	96k		
4 th generation Wall Mounted	Artcool Gallery																		
	Artcool Mirror																		
	Standard																		
4 th generation Ceiling Mounted Cassette	4 Way Cassette (570 x 570)																		
	4 Way Cassette (840 x 840)																		
	4 Way Cassette High Sensible (840 x 840)																		
	Round Ceiling Cassette																		
	2 Way Cassette																		
	1 Way Cassette																		
4 th generation Ceiling Concealed Duct	Mid / High Statics																		
	Low Statics																		
	High Sensible																		
4 th generation Fresh Air Intake																			
4 th generation Ceiling & Floor Convertible																			
4 th generation Ceiling Suspended																			
4 th generation Console																			
4 th generation Floor Standing	Floor Standing with Case																		
	Floor Standing without Case																		
4 th generation HYDRO KIT	Low Temperature																		
	High Temperature																		
4 th generation Energy Recovery Ventilator with DX Coil	with Humidifier																		
	without Humidifier																		

INDOOR UNITS FEATURE OVERVIEW

Energy Monitoring	2 Set Point	Occupied / Unoccupied Scheduling Function	Group Control	Test Run (Cooling)	Test Run (Heating)	Model Information Monitoring	Auto Addressing	Refrigerant Leakage Detection	Thermo On / Off Range Setting (Cooling)	Thermo On / Off Range Setting (Heating)	Static Pressure (Only for Ceiling Concealed Duct Type)	1 Point External Input (On / Off Control)	Filter Sign (Remaining Time)	Auto Restart Function Disable / Enable	Wi-Fi Ready

※ If 4th generation indoor units are connected to MULTI V WATER S, several functions are not available.
 ※ If 4th generation indoor units are combined to 2nd generation indoor units, several functions are not available.
 More detailed information, refer to the "MULTI V Indoor units Compatibility Table"

LG HVAC CONTROL LINE-UP

INDIVIDUAL CONTROL		CENTRALIZED CONTROL			
Wired Remote Controller		Wireless Remote Controller	Display	Platform	Gateway
Standard III (White)	Simple	NEW PWLSSB21H (H/P)	AC Ez PQCSZ250S0 (Indoor Unit -32)	ACP 5 PACP5A000 (Indoor Unit -256) BACnet IP / Modbus TCP	ACP LonWorks PLNWKB000 (Indoor Unit -64)
Standard III (Black)		Wi-Fi Controller LG Wi-Fi Modem For Indoor Unit PWFMD200	AC Ez Touch PACEZA000 (Indoor Unit -64)	AC Manager 5 PACM5A000 (Indoor Unit -8,192)	Modbus RTU Gateway PMBUSB00A
Standard II (White)			AC Smart 5 PACS5A000 (Indoor Unit -128) BACnet IP / Modbus TCP		PI-485 For Indoor Unit (ERV) PHNFP14A0
Standard II (Black)					
Premium					
PREMTA000 PREMTA000A PREMTA000B	PQRCHCA0QW (Simple for Hotel)				
	PQRCHCA0Q (Simple for Hotel)				

CENTRALIZED CONTROL	INTEGRATION DEVICE		
Facility Integrator	Indoor Unit		Outdoor Unit
	Dry Contact	Control Accessory	AHU Kit
PDI (Power Distribution Indicator) Premium (8 port) PQNUD1S40 Standard (2 port) PPWRDB000	Simple Dry Contact PDRYCB000	Group Control Wire PZCWRCG3	IO Module (Input / Output Module) For MULTI V 5 PVDSMN000
ACS IO Module (Input / Output Module) PEXPMB000	Dry Contact for Thermostat PDRYCB300	Remote Temperature Sensor PQRSTA0	Variable Water Flow Control kit For MULTI V WATER IV PWFCKN000
Chiller Option Kit PCHLLN000	Dry contact for Thermostat (For using universal input) NEW PDRYCB320	Low Profile Remote Temperature Button Sensor ZRTBS01	Low Ambient Kit For MULTI V IV, 5 PRVC2
ACU IO Module PEXPMB300	2 Points Dry Contact (For Setback) PDRYCB400	Zone Controller 4 Zones by thermostat ABZCA	Controller Module Main module NEW PAHCM000
UO PEXPMB200	For Modbus PDRYCB500		Cool / Heat Selector PRDSBM
UI PEXPMB100			Water Communication Module NEW PAHCMW000
			Control kit NEW PAHCNM000 (Max 3 Outdoor Units)
			EEV Kit (Electronic Expansion Valve) PRLK048A0 (- 28 kW) PRLK096A0 (- 56 kW)
			NEW PRLK396A0 (- 112 kW)
			NEW PRLK594A0 (- 168kW)

OUTDOOR UNITS

MULTI V 5 / MULTI V S / MULTI V M

MULTI V WATER IV (HEAT PUMP / HEAT RECOVERY)



MULTI V™ 5

- Air cooled VRF Heat Pump & Heat Recovery
- 22.4kW ~ 268.8kW (Cooling capacity based)
- 3Ø, 380 ~ 415V, 50Hz
- Top discharge outdoor unit
- Ability to function as Heat Pump or Heat Recovery

1,000M
TOTAL PIPING LENGTH

Design
For
The Ultimate

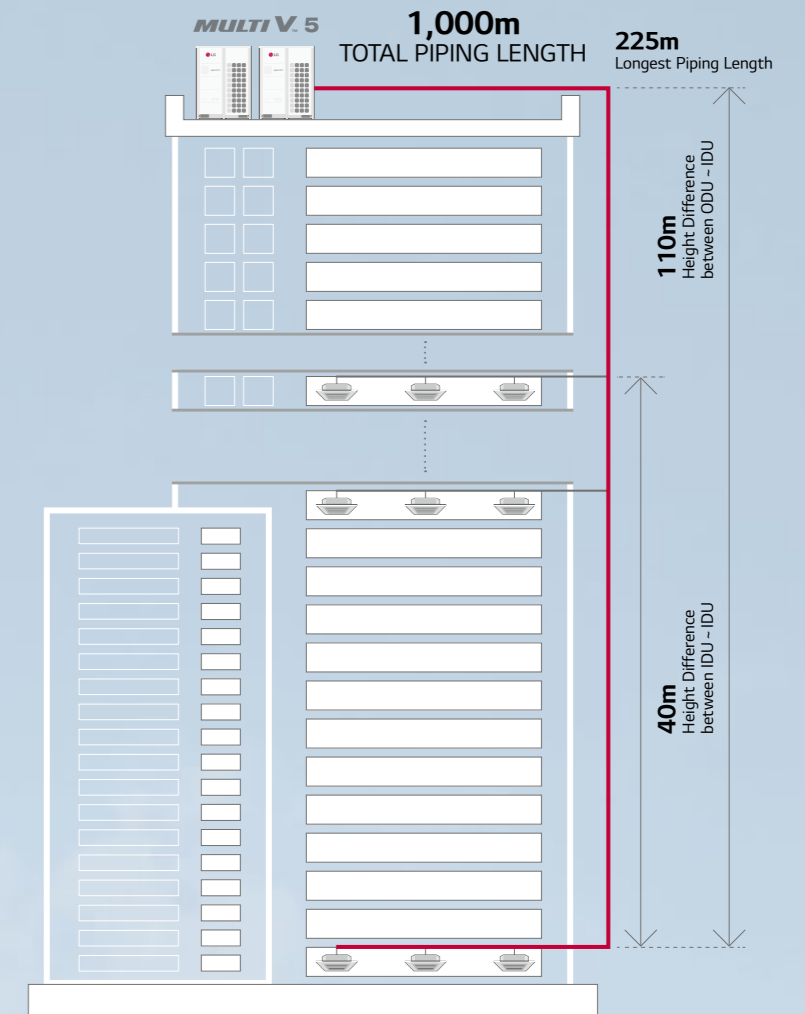

OUTDOOR
UNITS
MULTI V 5



Energy savings



Reliability



Low noise



Advanced performance

How does it work?

Dual Sensing



Partial Defrost



Interchangeable between
heat pump and heat recovery

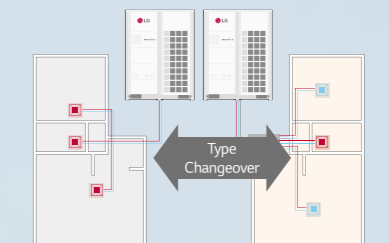

INNOVATIVE TECHNOLOGIES

Dual Sensing Smart Load Control (SLC)

Enhanced energy saving & increased indoor comfort

Cooling loads vary according to both temperature and humidity. With Dual Sensing SLC, work exerted to meet the load depends on both temperature and humidity. As a result, less capacity will be required in lower humidity conditions.

It influences the VRF system main processor's decision on where to set the system's target high or low system pressure values.

Smart Load Control responds to :

- 1) Outdoor ambient dry bulb temperature
- 2) Outdoor ambient relative humidity (when enabled)

Cooling Indoor Units - adjusts target low pressure

Raises the target low pressure value as cooling load falls and/or ambient temperature falls. Lowers the target low pressure value as cooling load rises and/or ambient temperature rises.

Heating Indoor Units - adjusts target high pressure

Lowers the target high pressure as heating load falls and/or ambient temperature rises. Raises the target high pressure as heating load rises and/or ambient temperature falls.

What are the benefits?

Enhanced energy savings

- Cooling Mode

By raising the target low pressure during off-peak cooling operation, the compressor lift is reduced. This slows compressor's speed which leads to a decrease in compressor's power consumption.

- Heating Mode

By lowering the target high pressure during off-peak heating operation, the compressor lift is reduced. This slows compressor's speed which leads to a decrease in compressor's power consumption.

Increased indoor comfort

Smart Load Control uses one (or two) sensors to measure changing outdoor weather conditions and prepares the VRF system for operation under the revised weather conditions before changing conditions impact indoor comfort.

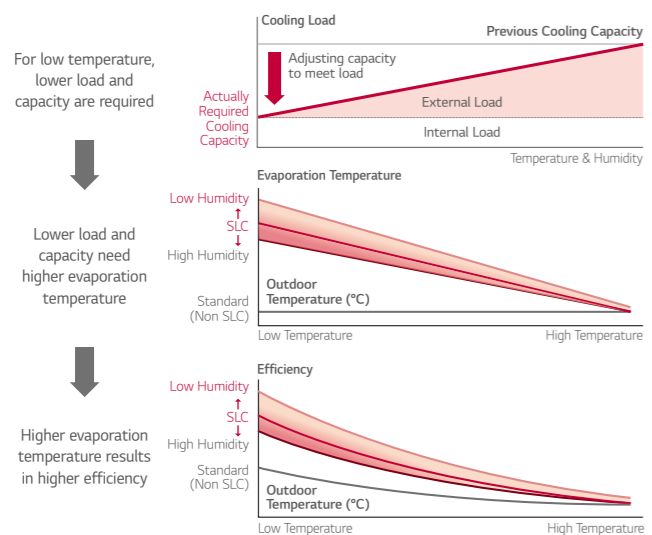
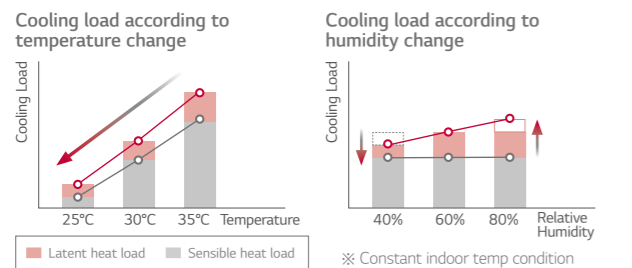

Energy Savings with Dual Sensing Control (Temperature & Humidity)

Case study

Weather characteristics of Warsaw, Poland

The portion of cooling operation hours at low humidity condition (Below 50% RH) is big. The cooling load of this condition is less than the load at standard (50 - 70% RH) or high (over 70% RH) humidity condition even in the same outdoor air temperature. MULTI V 5 raises the evaporating Temp up at low load (Low humidity) condition to enable energy saving and prevent over-cooling which can happen when the system is controlled only by using outdoor air Temp

Warsaw weather in Summer

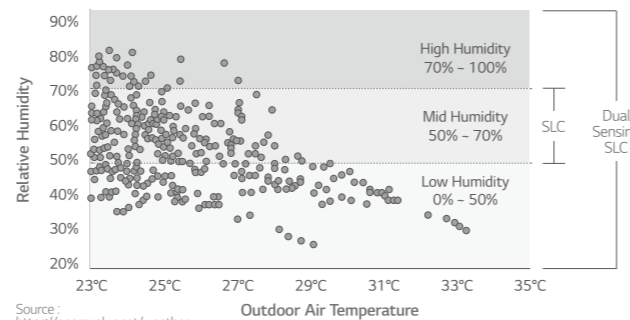

Source: <https://energyplus.net/weather>

Time Portion of Relative Humidity in Summer (Warsaw, Poland)

RH (%)	Portion
70% - 100%	8%
50% - 70%	45%
0% - 50%	47%

Energy Consumption in Cooling Season

When we compared the energy consumption between SLC (Outdoor air Temp sensing only) and Dual sensing SLC (Outdoor air Temp and humidity sensing), Dual sensing SLC control can save 6% more energy compared to SLC. So dual sensing control is more efficient than SLC.

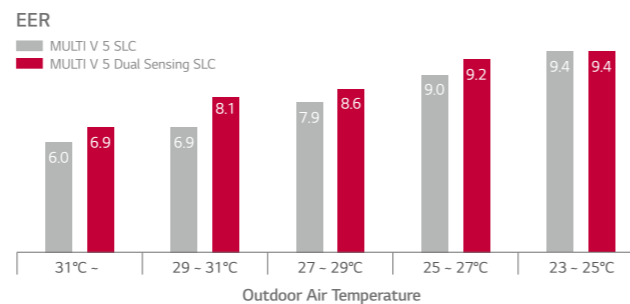

Power Consumption in Cooling Season

Yearly Power Input (kWh) - ODU

OAT	MV4 (Fixed)	MV5 SLC	MV5 Dual SLC
31 -	17	15	13
29 - 31	91	73	62
27 - 29	183	136	124
25 - 27	243	170	165
23 - 25	155	110	109
Total	690 (137%)	503 (100%)	474 (94%)

6% more energy saving compared to SLC

INNOVATIVE TECHNOLOGIES

Comfort Cooling

Increased indoor comfort & enhanced operating efficiency

First reference use Indoor Unit (IDU) is operating in a season when its load is less than the design load, the comfort cooling algorithm controls the indoor unit's coil superheat, thus raising the discharged air temperature as the space temperature is approaching set point. MULTI V 5's comfort control algorithm monitors the outdoor air temperature and humidity conditions. When changing weather conditions are deteriorating and there is a high potential the indoor unit's load will remain stable or may increase, comfort cooling delays or abandons raising the target superheat as the room temperature approaches set-point. When changing weather conditions are favorable to raising target superheat, target superheat is moderated.

What are the benefits?

Increased indoor comfort

If comfort cooling is turned off, and the temperature of the leaving air is not raised, when the fan speed is reduced to low speed, there is a potential that occupants located directly under a cassette IDU or supply air registers could feel cold air falling on them resulting in a lower overall comfort experience. With comfort cooling turned on, the discharged air temperature is controlled. When the IDU controller reduces the fan speed, the potential for cold air falling on occupants located under the cassette IDU or supply air registers is reduced.

Enhanced operating efficiency

Raising superheat reduces refrigerant volume flowing through the coil. As flow decreases, demand on the compressor decreases and the compressor speed will be reduced, thus saving energy.

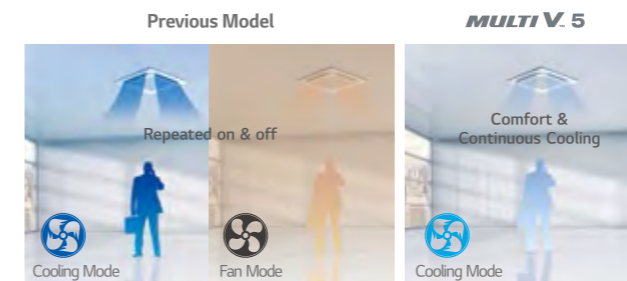

※ Indoor unit set up available with Standard III Remote Controller

Preventing cold draft & repeated turn On / Off

Improved Indoor Comfort

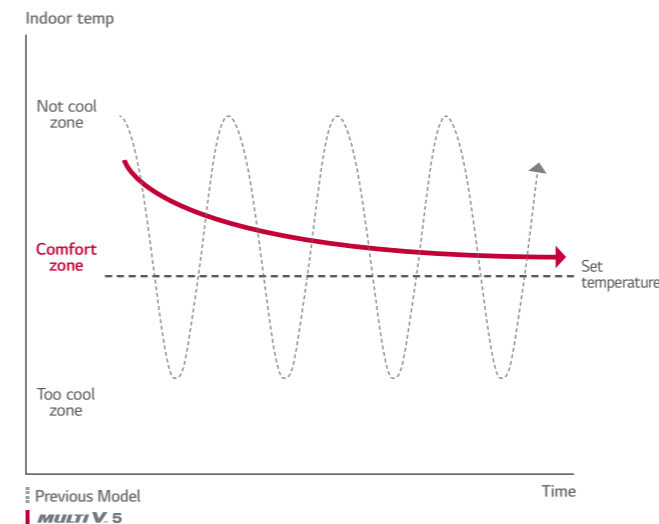

Previous Model
MULTI V. 5

Intelligent Defrost

Increased heating run-hours

MULTI V has provided an intelligent defrost algorithm and settings based on current outdoor ambient temperature. With the addition of the outdoor air humidity sensor, MULTI V 5 Intelligent Defrost just got smarter.

MULTI V 5 computes the current ambient air dew point temperature - the temperature at which frost will form on the outdoor unit coil in during winter operation. MULTI V 5 makes continuous adjustments to the refrigeration cycle's operating parameters to keep the outdoor coil surface temperature above actual dew point which can be calculated by using dry bulb Temp and relative humidity. When the refrigeration cycle's operating parameters can be adjusted no further without sacrificing heating comfort, further adjustment is stopped and frost is allowed to build on the coil, therefore activating defrost.

What are the benefits?

The Intelligent Defrost algorithm increases the VRF system's heating run-hours and reduces the number of defrost cycles required to maintain optimum heating performance irrelevant of the mode and method of defrost selected.

Conventional Defrost

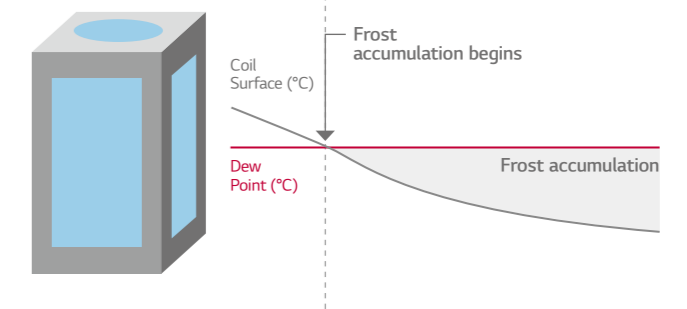

LG Intelligent Defrost / Smart Heating

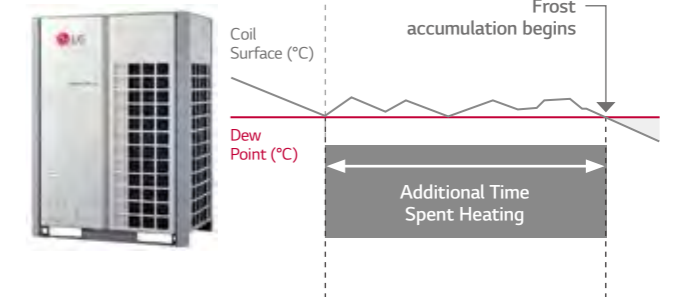

※ Increased heating operation time per day : Up to 17%

- LG Internal Test result,
- Test condition (MULTI V 5 vs MULTI V IV, 22HP)
- Outdoor : 2/1°C , Indoor : 20/15°C
- Humidity : 83% , Dew Point : -0.5°C

INNOVATIVE TECHNOLOGIES

Variable Path Heat Exchanger

Optimized system efficiency & continuous heating

MULTI V 5 outdoor units (ODU) are manufactured with horizontally split ODU coil consisting of two independent circuit sections. Each half of the coil is independently controlled.

This split coil feature makes it possible for MULTI V 5 to provide continuous heating during defrost. The split coil and valve arrangement also makes it possible for the MULTI V 5 to change the flow path of refrigerant through one of the two coils only, or through both coils in either a series or parallel arrangement. Based on system pressures, ambient temperature conditions, and mode of operation, the system controller may modify the selected path at any time.

What are the benefits?

Optimizes system efficiency regardless of operating modes as ambient weather conditions change.

Customizes the used area of the outdoor unit's heat exchange surface.



Low ambient cooling and / or light building load

- Half active
- Lower idle



Full load cooling

- Upper & lower active
- Series circuited
- High velocity refrigerant flow



Heating - all conditions

- Upper & Lower active
- Parallel circuited
- Low velocity refrigerant flow

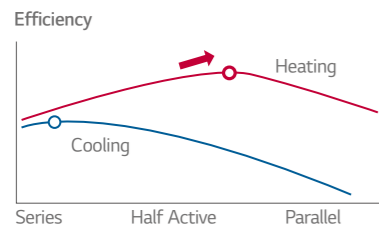

Continuous Heating

Heating performance

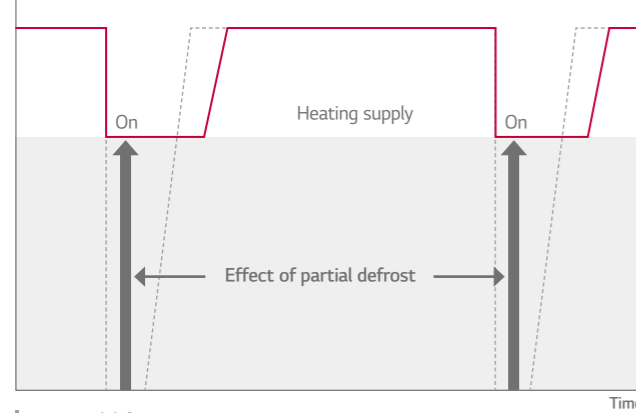

Non-Partial defrost
MULTI V 5

Active Refrigerant Control

Stable operation & sustaining most efficient operation

The accumulator in the outdoor unit has a storage tank mounted inside known as the receiver tank. The receiver tank is equipped with inlet and outlet valves that are electronically opened and closed. Refrigerant is being passed between the accumulator and the receiver tank on a continuous basis. MULTI V 5 active refrigerant control algorithm goal is to minimize the amount of refrigerant in circulation. The lower the volume in circulation the lower the cost to move it around the system and the higher the stability of the refrigeration cycle. It accomplishes this by constantly monitoring the system operating pressures and temperatures and a variety of other vital control metrics of the refrigeration cycle. When the cycle is out of balance, an adjustment in the amount of circulating refrigerant occurs.

What are the benefits?

Widens the ambient temperature range at which stable operation occurs. Sustains most efficient system operation regardless of outdoor weather conditions, operating mode, or building load.

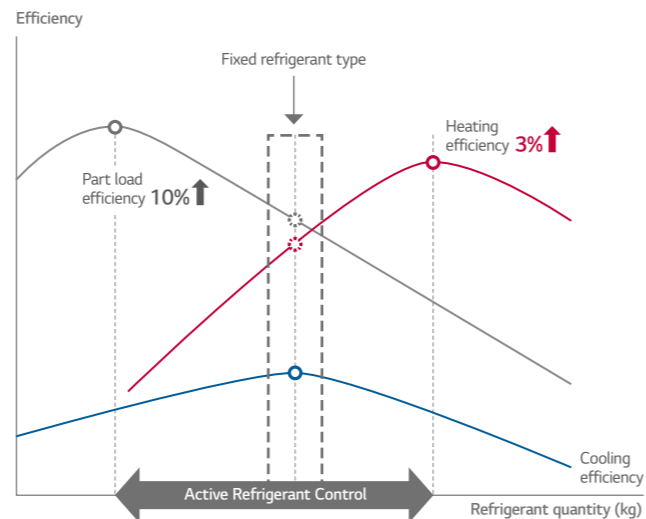
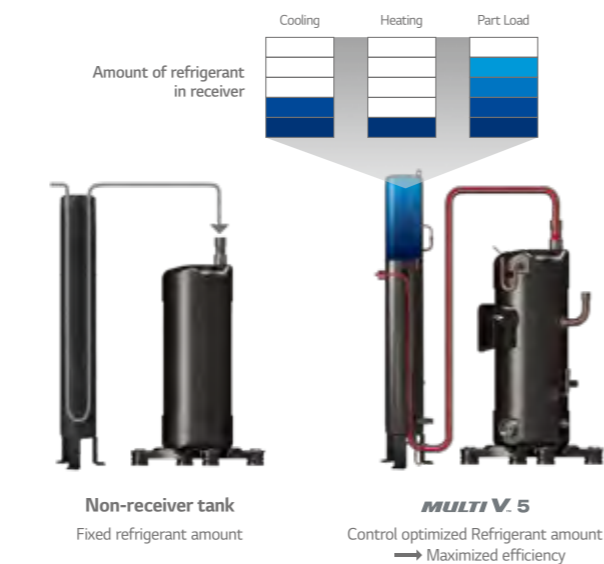

INNOVATIVE TECHNOLOGIES

HiPOR™

Advanced compressor reliability & efficiency

HiPOR™ is an LG trademark that stands for High Pressure Oil Return. It consists of an oil separator, oil drain line between the separator and the compressor. HiPOR™ technology enables oil to return directly into the compressor, instead of returning through the refrigerant suction pipe. This prevents energy waste when oil flows between the separator and the compressor. Because the operating pressure in the chamber containing the oil sump of the compressor and the pressure in the oil separator are nearly equal, there is no loss in compressor efficiency.

What are the benefits?

Maximizes reliability and efficiency of the compressor

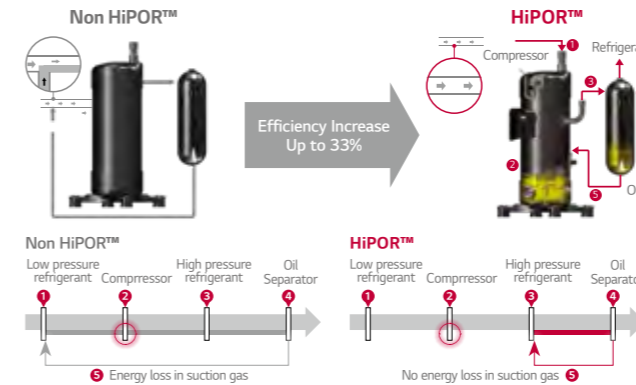

• LG Internal Test result,
• Test condition - 15Hz Rating Condition : TC = 37.9C°, Te : 7.2C°

Smart Oil Management

Energy saving, enhanced heating & increased compressor reliability

MULTI V 5 performs oil return when needed under normal operating conditions. An oil level sensor is provided in every LG VRF compressor. If the sensor indicates the compressor oil level is low, the main system processor is notified that an oil return cycle is necessary. Oil balancing cycle occurs every hour and does not hinder system performance. It balances the oil level deposit between both compressors in multi-compressor frames. Older VRF technology protects compressors from oil loss based on timed oil return logic because there was no way to know if the oil level in any one compressor was low. LG's unique oil level measuring sensor actively monitors the oil level in each compressor.

What are the benefits?

Energy savings : fewer oil return cycles eliminate unnecessary energy consumption.

Increases system heating run-time during winter operation.

Increases compressor reliability.

Heating Performance

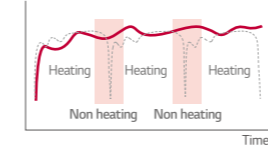

Timed oil return logic (Non-oil Sensor)

MULTI V 5

Increased heating operation time per day : Up to 12%

• LG Internal Test result,
• Test condition
- without oil level sensor : every 8 hour oil recovery operation
- with oil level sensor : non oil recovery operation

Smart Oil Return

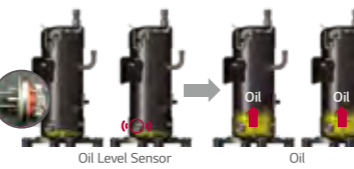

Auto Oil Balancing

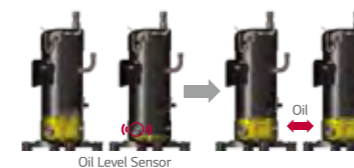

Sub-cooling & Vapor Injection

Increased heating performance

MULTI V 5 is equipped with advanced sub-cooler and vapor injection control system. The sub-cooler algorithm sub-cools liquid refrigerant just enough so that it can travel to the farthest IDU in the system operating in cooling mode without changing state. During low ambient operation down to -25°C (Heating mode), the sub-cooler provides medium temperature refrigerant gas to the compressor's vapor injection system. When injected into the compression chamber, system mass flow increases which stabilizes the system's suction pressure. In all cases the vapor injection increases the compressors cycle efficiency and reduces operating cost.

What are the benefits?

Provides stable refrigeration cycle operation over a wide range of outdoor ambient operating conditions.

Increases compressor efficiency when compared to systems without vapor injection technology.

Technology Mechanism

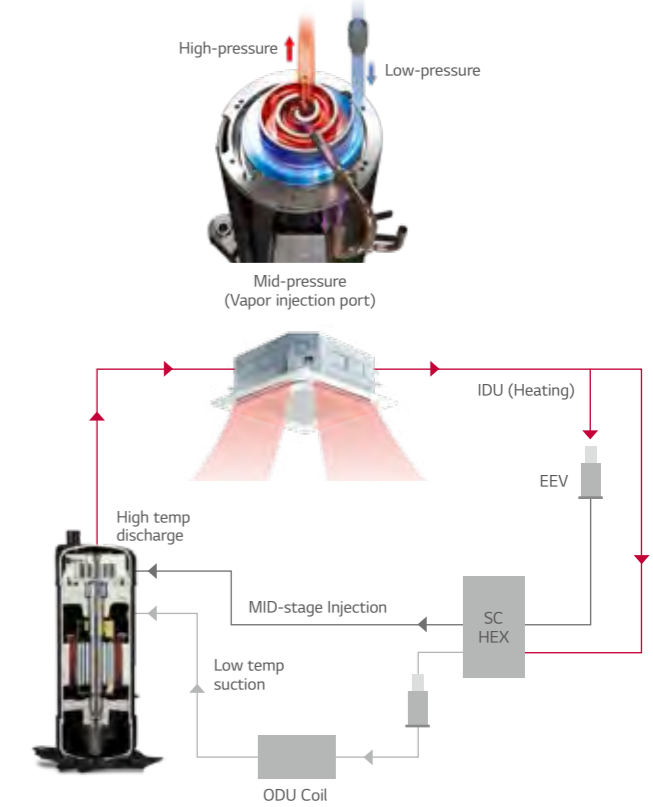

Performance Comparison

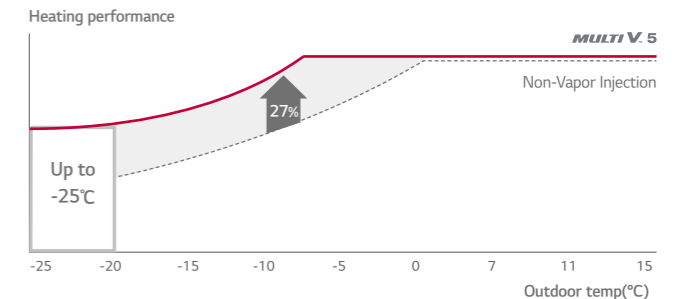

※ Improved heating performance by 27%
※ Comparison tested on 10HP model

INNOVATIVE TECHNOLOGIES

Corrosion Resistance Black Fin

Improved durability

The black coating with enhanced epoxy resin is applied on the heat exchanger for strong protection from various corrosive external conditions such as salt contamination and air pollution. Moreover, the hydrophilic film keeps water from accumulating on the heat exchanger's fin, minimizing moisture buildup and eventually making it even more corrosion resistant. LG Corrosion Resistance solution passed ISO 21207 accelerated corrosion test conducted by an independent test organization and the result has been certified by prestigious global certification organization, TÜV.

What are the benefits?

This improvement in durability prolongs the product's lifespan and lowers both the operational and maintenance costs.



※ Verification of corrosion resistance performance
 - Declared by TÜV Rheinland
 - Test Method B of ISO21207
 - Test condition : Salt contaminated condition + severe industrial/traffic environment(NO₂ / SO₂)

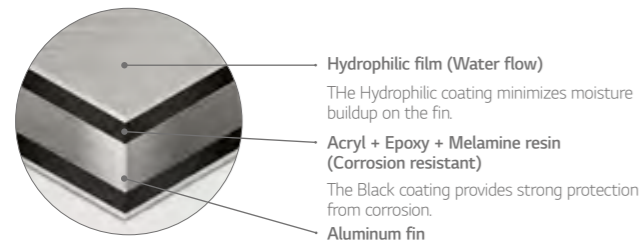

SST (Salt Spray Test)

Test Process



Test process is conducted according to ISO 9227.
 1) Salty water concentration : NaCl aqueous solution (5%)

Test Result
 (5% Area of defects compared to initial)

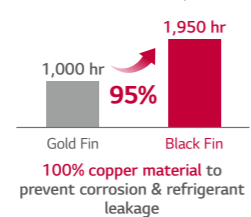

CCT (Cyclic Corrosion Test)

Test Process

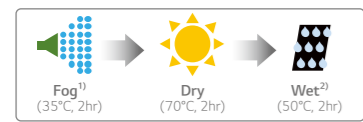

※ Test process is conducted according to ISO 14933.
 1) Salty water concentration : NaCl aqueous solution (5%)
 ※ Dry condition changed : 60°C, 4hr → 70°C, 2hr
 2) Deionized water

Test Result
 (5% Area of defects compared to initial)

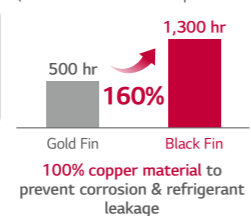

Biomimetic Fan

Maximized performance

The fans in Multi V 5's outdoor unit have been upgraded to feature a moire pattern similar to that of a clam shell's exterior that help with noise reduction. At the same time, unlike the fans installed in previous products that generate separation of flow due to absence of tubercles, the bumpy back design inspired by the bumps on the humpback whale's flipper is applied as the tubercles on the back side of the fans, increasing wind power by reducing flacking. In addition to the biomimetic technology-based fans, extended shroud of MULTI V 5 allows more high static pressure and helps fans to blow higher air volume for efficient operation. With wider air guide, discharged air current is stabilized and noise level is reduced.

What are the benefits?

Based on the biomimetic technology, the fans of MULTI V 5 increased air flow rate by 10% in comparison to previous model and reduced its power consumption up to 20% when compared with the fan blade design on MULTI V IV. This eventually results in maximized performance with large capacity.

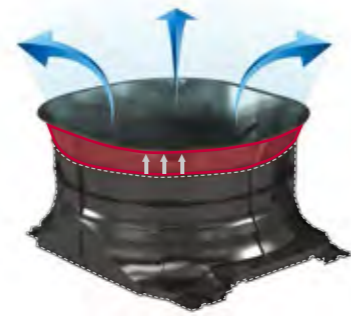

Air flow rate

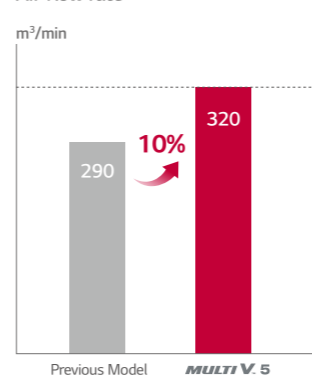

※ Comparison based on 20HP model

Power consumption

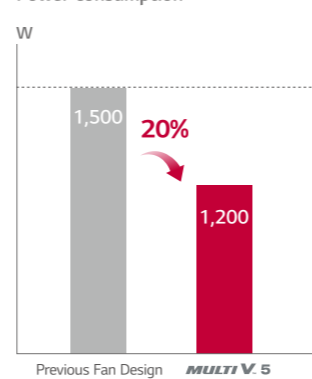

※ Comparison based on air volume of 290m³/min

DESIGN FLEXIBILITY

One Unified Model

Heat pump / Heat recovery with one platform

LG MULTI V 5 satisfies users' various needs with just one platform. Heat Pump System works for the sites where either cooling or heating operation is needed, while Heat Recovery System fits perfectly to the sites wherein both the cooling and heating operations are simultaneously needed or locations installed with Hot Water Solution to provide hot water and heating via radiators.

What are the benefits?

MULTI V 5 allows the building previously installed with Heat Pump system to switch to the Heat Recovery system (by adding HR boxes and a third pipe) for changing purpose of the building or remodeling reasons via simple piping construction.

Heat Pump System

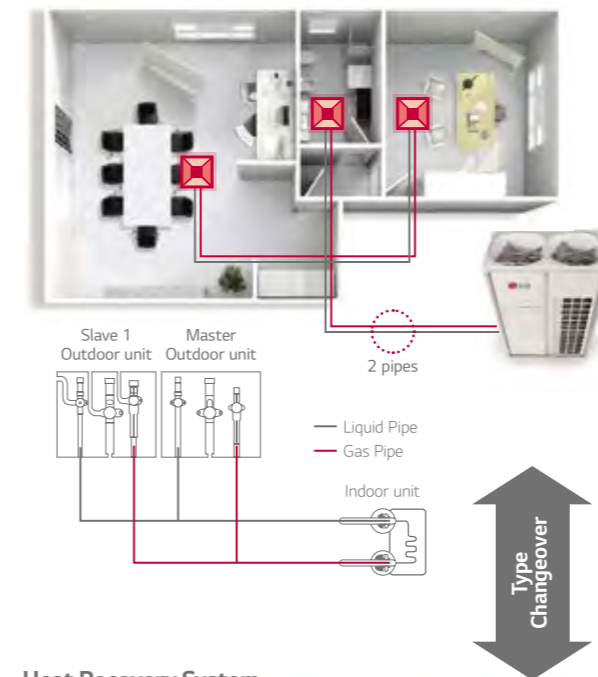

Heat Recovery System

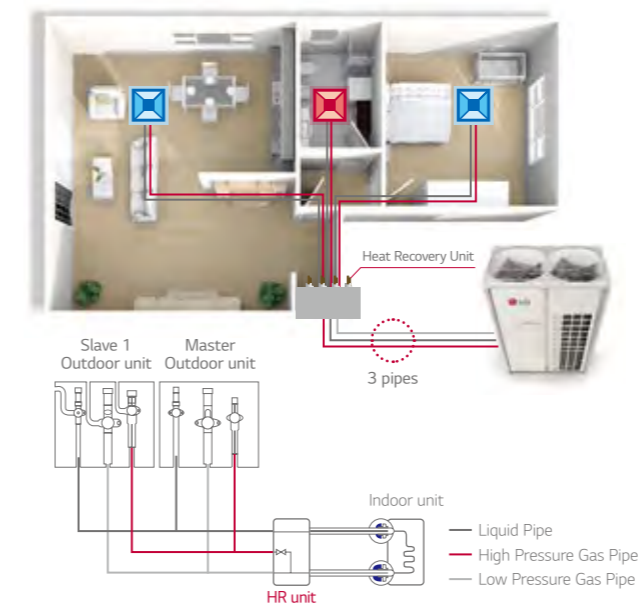

Flexible Installation with Large Capacity Outdoor Units

More flexible design potential & space saving

Large capacity outdoor units of MULTI V 5 minimize installation space that spares valuable floor space and significantly decreases total installed weight. This gives users more flexible design potential and better use of the saved space.

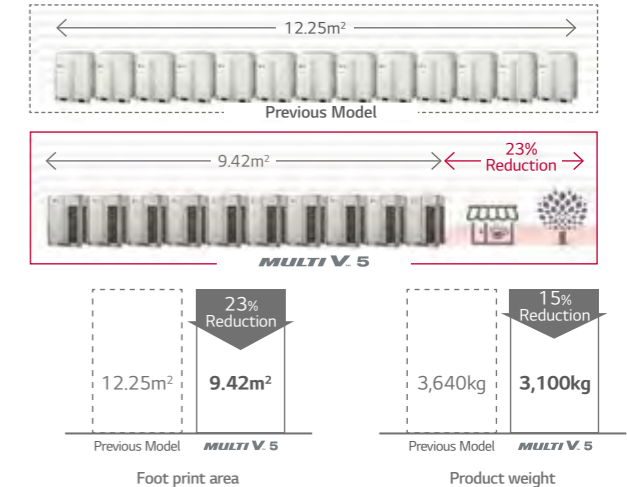

※ Comparison basis : 1 Rows of outdoor units 728kW (72.8kW x 10sets) installation case

Wider Operation Range

Able to operate at extreme conditions

With improved inverter cooling technology, sub-cooling and vapor injection, MULTI V 5 offers an extended range of heating and cooling operations. It can perform normal heating operations at temperatures as low as -25°C. Cooling operations function at temperatures as low as -15°C or as high as 48°C making it an adequate solution for specialized areas like technical rooms. Moreover, MULTI V 5's cycle technology with enhanced durability enables optimal cooling performance at high temperature that increases up to 48°C.

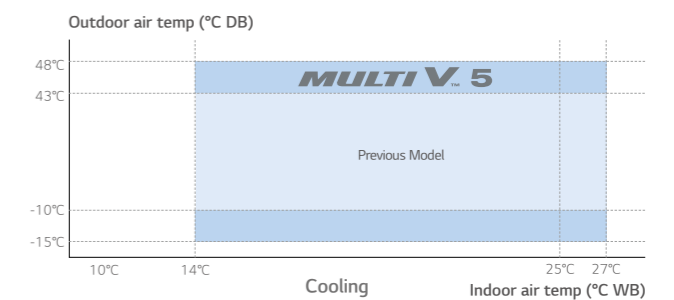
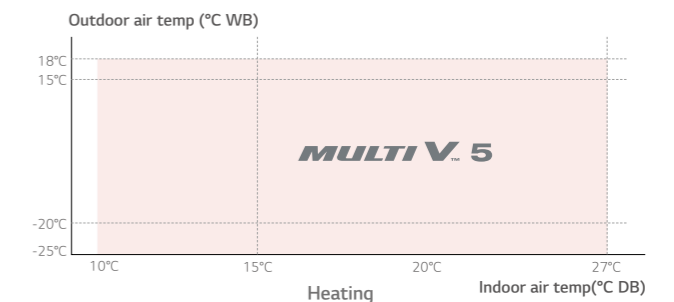

USER-FRIENDLY CONTROL

Low-Noise Operation

For noise sensitive environment

Unlike the previous model which enables Low-Noise Operation only during night after judgment time, the Low-Noise Operation of MULTI V 5 can function regardless of the time at the noise sensitive areas. When used, the speed of the outdoor unit fans is restricted during normal operation.

Previous Model

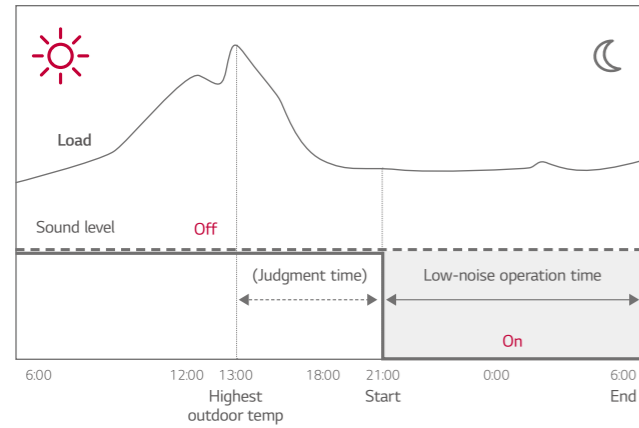

MULTI V 5

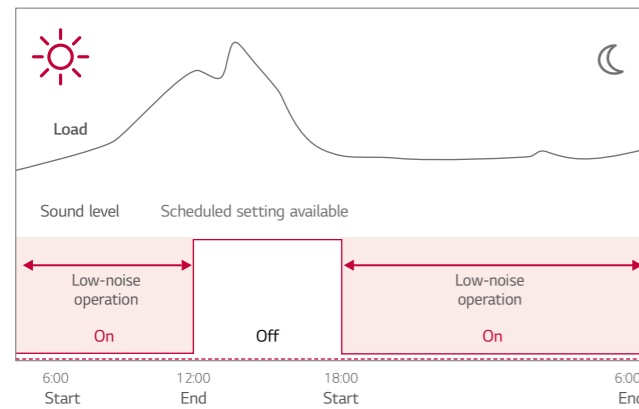

Indoor setting available



Simple Test Run via LGMV

Increased overall efficiency in installation

To make sure that the product functions properly, conducting a test run is recommended. For previous product, professional engineer who is well-aware of more than 40 different functional settings and more than 200 error codes had to check main parts in order to make sure that the test run had succeeded. With Mobile LGMV of MULTI V 5, fast and accurate auto test run can be executed and the professional installer running the test can receive test results via email, which shortens installation hours and increases overall efficiency in installation processes.

Previous



MULTI V 5



Wi-Fi MV Module



Cycle Monitoring Diagnosis Installation Smart Management

LGMV



Nomenclature

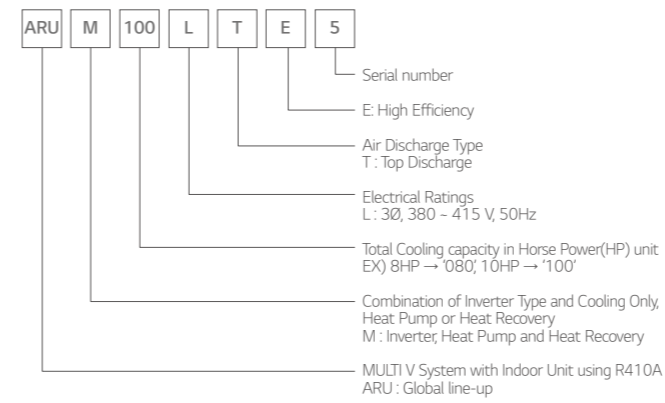

Position of Sound Pressure Level Measuring

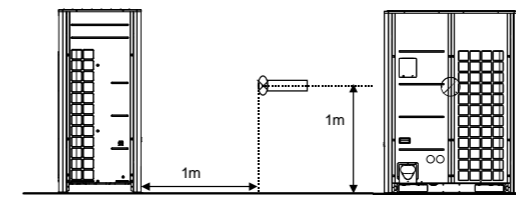

- Data is valid at free field condition
- Data is valid at nominal operating condition
- Sound level will vary depending on a range of factors such as the construction (Acoustic absorption coefficient) of particular room in which the equipment is installed
- Sound level can be increased in static pressure mode or used air guide.

Outdoor Units Function

Category	Functions	MULTI V 5
Key Refrigerant Components	Variable Path of Outdoor Unit HEX	○
	HiPOT™ (High Pressure Oil Return)	○
	Humidity Sensor	○
	Corrosion Resistance Black Fin	○
	Oil Sensor	○
Useful Function	Dual Sensing	○
	Low Noise Operation	○
	Hgh Static Mode of Outdoor Unit Fan	○
	Partial Defrosting	○
	Auto Dust Removal of Outdoor Unit (Fan reverse rotation)	○
	Indoor Cooling Comfort Mode Based Outdoor Temperature	○
	Smart Load Control (SLC) (Changing indoor discharge air temperature according to load)	○
	Outdoor Unit Control Refer to Humidity	○
	Defrost / Deicing	○
	High Pressure Switch	○
Reliability	Phase Protection	○
	Restart Delay (3-minutes)	○
	Self Diagnosis	○
	Soft Start	○
Central Controller	Test Run Function	○
	AC Ez (Simple Controller)	PQCSZ250S0
	AC Ez Touch	PACEZA000
	AC Smart IV	PACS4B000
	AC Smart 5	PACS5A000
	ACP (Advanced Control Platform) IV	PACP4B000
	ACP (Advanced Control Platform) 5	PACP5A000
	AC Manager 5	PACM5A000
	ACP Lonworks	PLNWKB000
	ACP BACnet	PQNF17C0
Installation	Refrigerant Charging Kit	PRAC1
	Variable Water Flow Valve Control Kit	-
PDI (Power Distribution Indicator)	Standard	PPWRDB000
	Premium	PQNUD1S40
Cool / Heat Selector		PRDSBM
Low Ambient Kit		PRVC2
IO Module (ODU Dry Contact)		PVDSMN000
Cycle Monitoring Device	LGMV	PRCTILO
	Mobile LGMV	PLGMVW100

※ ○ : Applied, - : Not Applied

Cooling / Heating Operation

Cooling

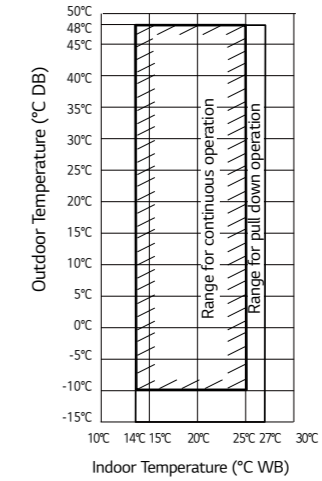

Heating

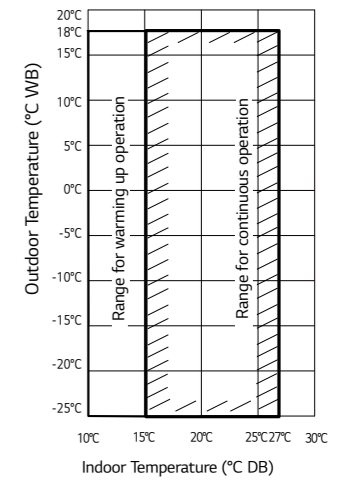

Note

- These figures assume the following operating conditions:
Equivalent piping length : 7.5m
Level difference : 0m
- Range of pull down operation :
If the relative humidity is too high, cooling capacity can be decreased by the sensible heat reduction.
- Warming up operation means that the outdoor unit operates to reach the range of continuous operating, however it may not operate continuously due to safety or protection logic.

Simultaneous Cooling / Heating Operation

Cooling

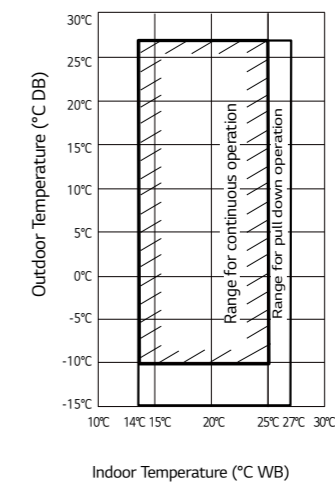

Heating

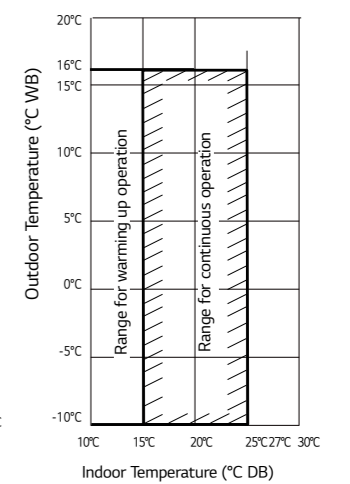

Note

- These figures assume the following operating conditions:
Equivalent piping length : 7.5m
Level difference : 0m
- Range of pull down operation :
If the relative humidity is too high, cooling capacity can be decreased by the sensible heat reduction.

ARUM080LTE5 / ARUM100LTE5 / ARUM120LTE5

[Unit : mm]

No	Part Name	Description
1	Leakage test hole (Side)	Ø22.2
2	Wire routing hole (Bottom)	2-Ø22.2
3	Power cord routing hole (Bottom)	2-Ø50
4	Pipe routing hole (Front)	-
5	Pipe routing hole (Bottom)	2-Ø66, Ø53.88
6	Power cord routing hole (Front)	2-Ø45
7	Wire routing hole (Front)	2-Ø30

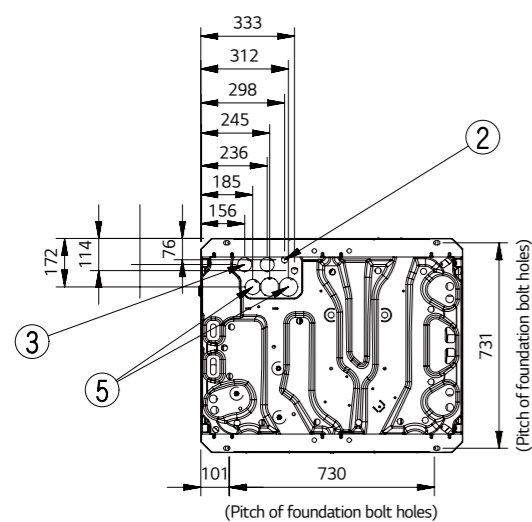
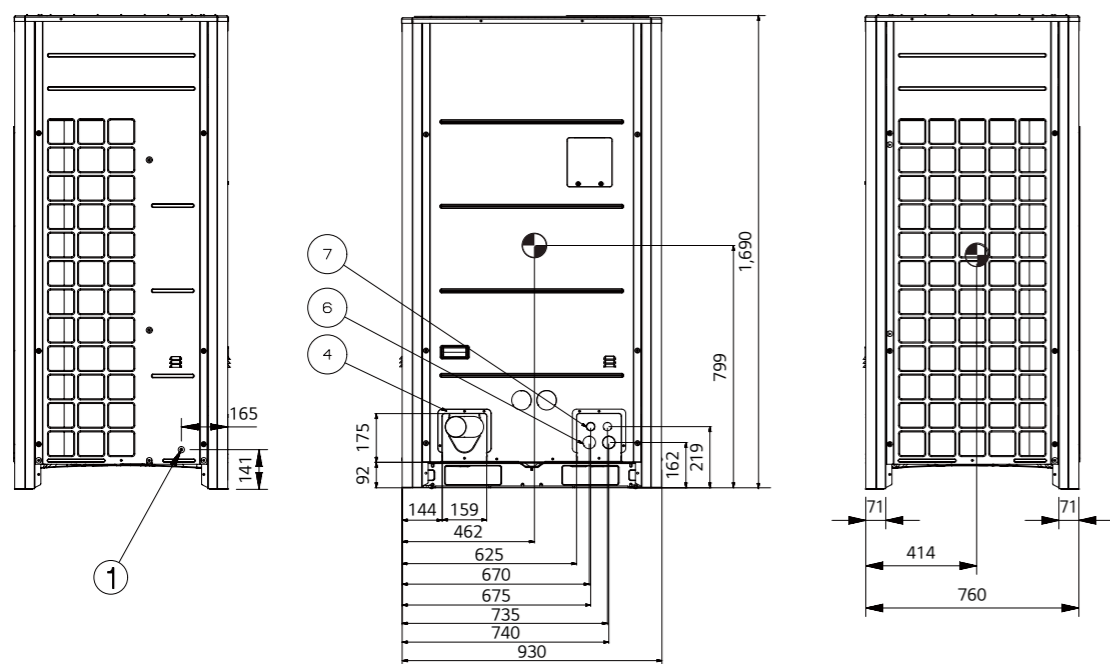
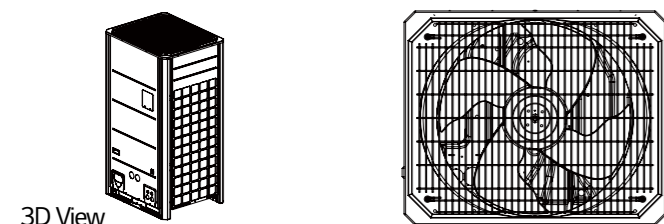

ARUM140LTE5 / ARUM160LTE5 / ARUM180LTE5 / ARUM200LTE5
ARUM220LTE5 / ARUM240LTE5 / ARUM260LTE5

[Unit : mm]

No	Part Name	Description
1	Leakage test hole (Side)	Ø22.2
2	Wire routing hole (Bottom)	2-Ø22.2
3	Power cord routing hole (Bottom)	2-Ø50
4	Pipe routing hole (Front)	-
5	Pipe routing hole (Bottom)	2-Ø66, Ø53.88
6	Power cord routing hole (Front)	2-Ø45
7	Wire routing hole (Front)	2-Ø30

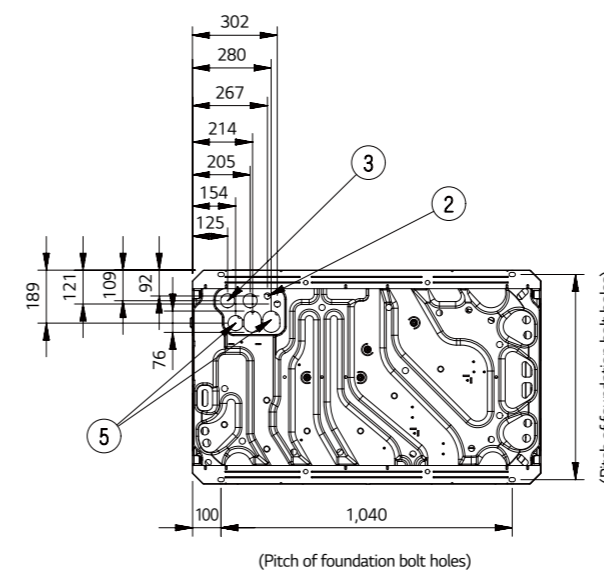
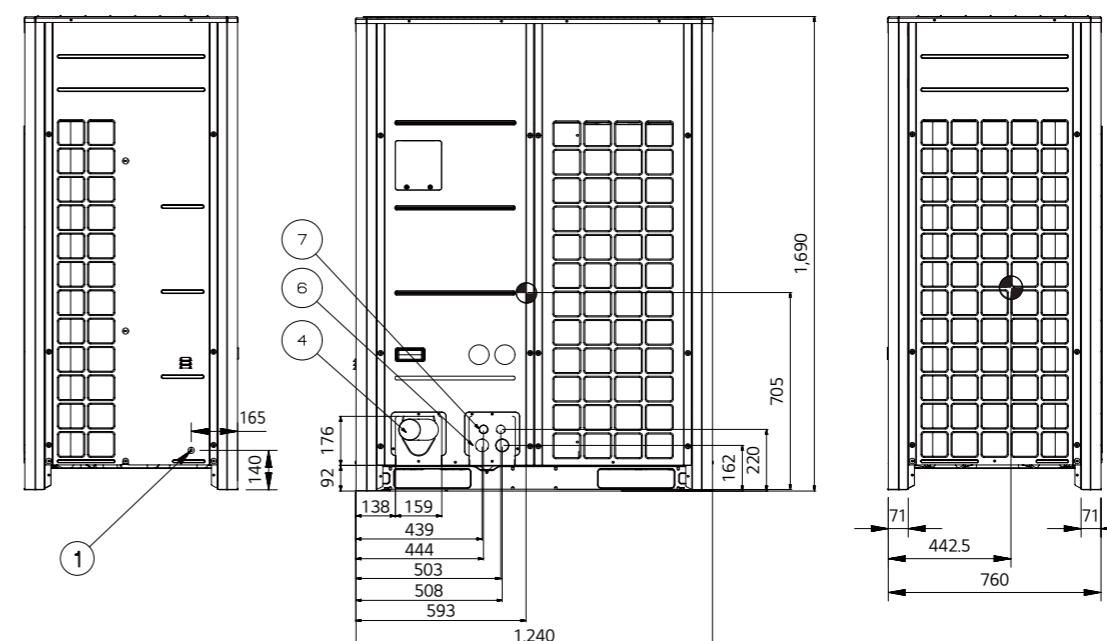
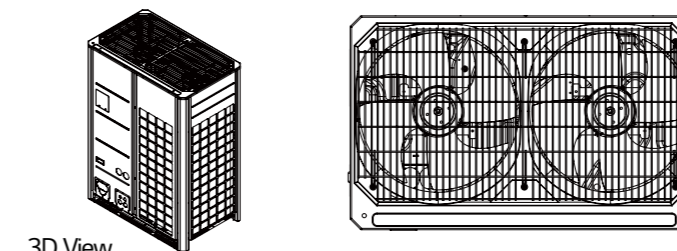

MULTI V 5 Q&A

Q1 What are the differences between MULTI V IV and MULTI V 5?

Category	MULTI V IV H/P (ARUN***LTE4)	MULTI V 5 H/P & H/R (ARUM***LTE5)
Vapor Injection	○	○
HiPOR™	○	○
Smart Oil Control (Oil Level Sensor)	○	○
Active Refrigerant Control	○	○
Variable Heat Exchanger Circuit	○	○
Continuous Heating	○	○
Smart Load Control	○	○
Dual sensing (Humidity Sensor)	-	○
Comfort Cooling	○	○
Ocean Black Fin	-	○
Maximum Capacity (1 Unit / 4 Unit)	20 HP / 80 HP	26 HP / 96 HP
Height Difference (ODU - IDU / IDU - IDU)	110m / 40m	110m / 40m
Cooling Operating Range (OAT, °CDB)	-10 ~ 43	-15 ~ 48
Heating Operating Range (OAT, °CWB)	-25 ~ 18	-25 ~ 18
Combination ratio of IDU	1 Unit	50 ~ 200%
	2 Unit	50 ~ 160%
	3 or 4 Units	50 ~ 130%

※ ○ : Applied, - : Not Applied

Q2 Can MULTI V 5 ODU be connected with the 2 series indoor unit?

A2 Yes, MULTI V 5 ODU can be connected with the 2 series indoor unit. In this case, the ODU DIP Switch No.3 should be "OFF" which is default setting. Refer to the below table.

ODU	IDU	Compatibility	ODU DIP Switch No. 3	If dip switch setting is not correct	Ref.
	Gen. 2 (ARNU*2)	○	Must be OFF (factory default)	Can not communicate between Indoor & Outdoor unit (System will not be operated)	
MULTI V IV MULTI V 5	Gen. 4 (ARNU*4)	○	Must be ON to enable gen. 4 functions	When Dip Switch No. 3 is OFF, System can be operated, but some function of Gen. 4 is not available	
	Gen. 2 + Gen. 4	○	Must be OFF (factory default)	When Dip Switch No. 3 is ON, Can not communicate between Gen. 2 Indoor & Outdoor unit (Gen 2 units are not operated), only Gen 4 Units are operated.	Some functions of Gen.4 are not available

※ ○ : Applied, - : Not Applied

ODU dip switch setting procedure (No.3)

ODU main PCB dip switch is all "OFF" at default state

- (1) Check and make sure that all connected indoor units are 4 series. (ARNU*****4.)
- (2) Change Dip switch No. 3 from OFF → ON
- (3) Push the reset button.

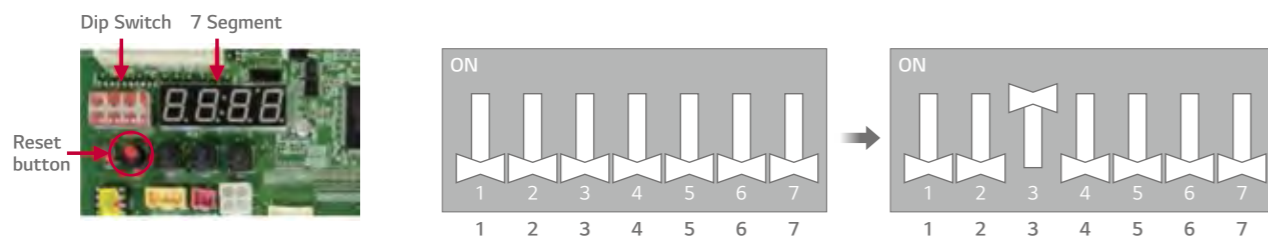

MULTI V 5 Q&A

Q3 How does MULTI V 5 operate when humidity reference of the dual sensing SLC is that of the outdoor?

A3 During dual sensing SLC, outdoor unit changes target pressure of the system referring to temperature and humidity in cooling mode.
 - When the humidity of outdoor side is higher than that of indoor side, outdoor unit will lower target pressure to remove humidity, thus outdoor unit will consume more energy and indoor will be more cooled compared to SLC operation but more efficiency than normal operation

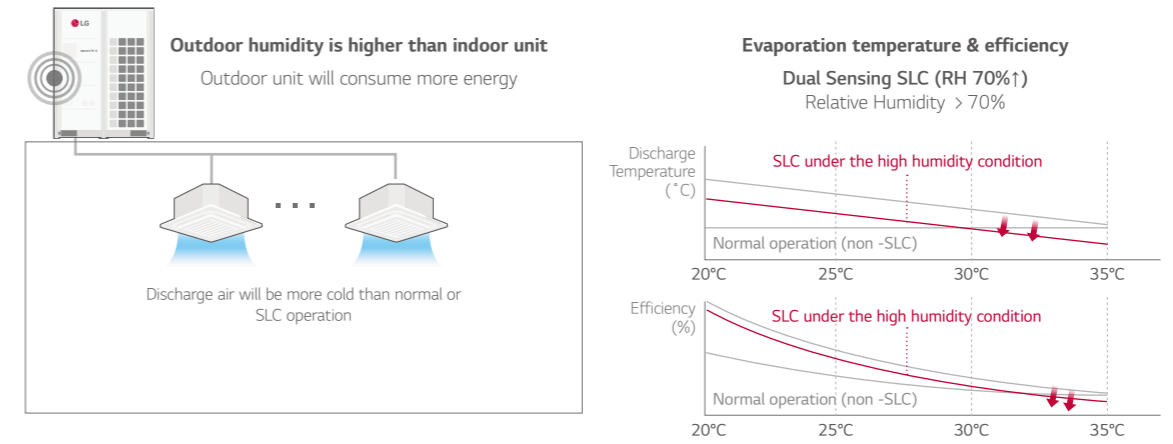

- When the humidity of outdoor side is lower than that of indoor side, outdoor unit will rise target pressure to save energy and keep comfort, but indoor humidity will be less removed compared to normal operation.

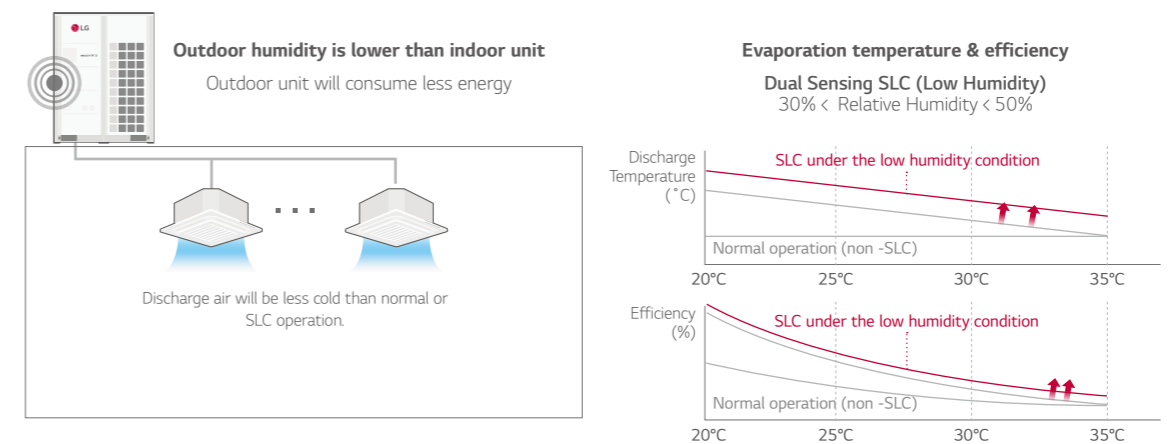

To maximize comfort and energy efficiency, the outdoor unit's humidity sensing can be turned off or a standard remote control can be installed to sense indoor humidity.

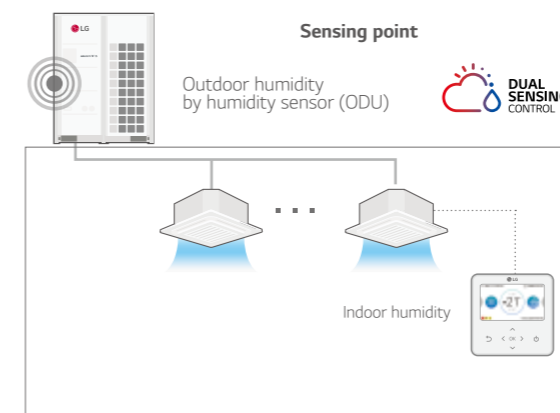

SLC Setting

CASE 1. Dual Sensing SLC with Outdoor humidity sensor in ODU Setting

DIP-SW01
 7-Segment
 SW04C (X: cancel)
 SW03C (▶: forward)
 SW02C (◀: backward)
 SW01C (●: Confirm/Automatic Addressing)
 SW01D (reset)

Setting summary
 DIP-SW01 #5 On
 Func > Fn14 > Off, op1 - op3

CASE 2. Dual Sensing SLC with Indoor humidity sensor in New Standard R/C setting (PREMTB100)

Setting summary
 Function? Smart Load Control
 Off, op1 - op3

※ User can turn off humidity control in ODU Setting (humidity reference)
 <Setting summary> ODU DIP-SW01 #5 On > Func > Fn16 > Off

Q4 What is the principle and accuracy of humidity sensor?

A4 Total Tolerance (%) = Sensor measurement tolerance (%) + Location of sensor tolerance (%)

The capacitive measurement principle established and proved itself as a standard in the past. For this principle, the sensor element is built out of a capacitor. The dielectric is a polymer which absorbs or releases water proportional to the relative environmental humidity, and thus changes the capacitance of the capacitor. This change in capacitance can be measured by an electronic circuit. For humidity sensors with CMOSens® technology, a "micro-machined" finger electrode system with different protective and polymer cover layers forms the capacitance for the sensor chip, and, in addition to providing the sensor property, simultaneously protects the sensor from interference in ways previously not achieved.

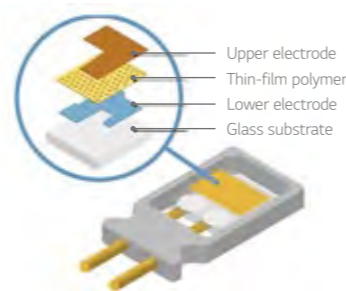

Model	Humidity Sensor of Outdoor	Humidity Sensor of R/Controller
Size (mm)	3 x 3 x 1.1	2.5 x 2.5 x 0.9
Supply voltage range	2.1 to 3.6 V	2.4 to 5.5 V
RH operating range	0 - 100% RH	0 - 100% RH
T operating range	-40 to +125°C (-40 to +257°F)	-40 to +125°C (-40 to +257°F)
RH response time	8 sec (tau 63%)	8 sec (tau 63%)

Q5 What is difference in refrigerant piping connection between heat pump and heat recovery?

A5 From MULTI V 5, Low pressure gas pipe in heat pump operation changes to high pressure gas pipe in heat recovery operation due to internal cycle. So for heat pump cycle, no. 1, 3 pipe should be connected and for heat recovery operation, No. 1, 2, 3 pipe is connected. (For the heat pump operation, DO NOT connect No.2 pipe)

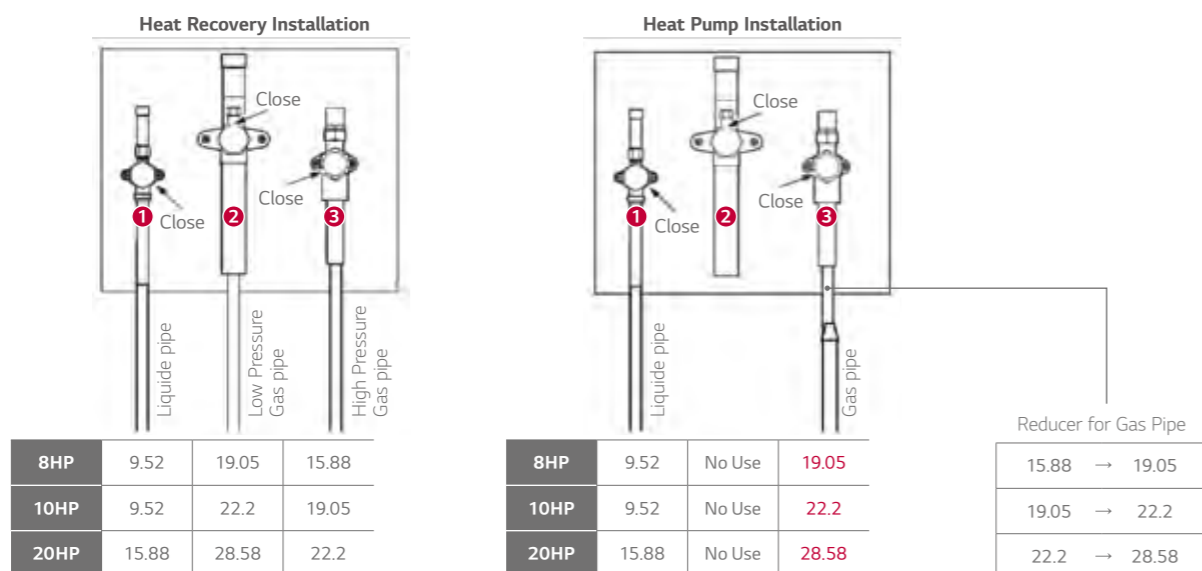

※ For using as Heat Pump, Reducer for Gas pipe should be used. Reducer is included in outdoor unit.

MULTI V 5 Q&A

Other Questions

Item	Question	Answer
Fan	The static pressure of MULTI V 5 is Max 8 mmAq as MULTI V IV??	Yes, the static pressure of MULTI V 5 is the same as MULTI V IV.
Compressor	Is the limitation of Compressor max Hz applied by the capacity of outdoor unit?	No, the limitation of comp Hz is not applied for default. But, it can be set by option for limitation of max Hz (or current).
4 Way V/V	The usage of main & sub 4 way valve for MULTI V 5 ?	MULTI V 5 has the function of both H/P and H/R by one unit. Main valve has a function to change the operation mode. (Cooling ↔ Heating) Sub. Valve has a functions to change the product type (H/P ↔ H/R)
VI	In case of vapor injection, how much is the middle pressure?	The optimal middle pressure for vapor injection is 1.2 P _s . P _s : Suction pressure of compressor
VI	By how much is heating capacity increased by vapor injection?	Generally, the heating capacity is increased up to 15 - 20%.
Humidity Sensor	Where is Indoor Humidity sensor?	It is placed inside of the RS3 remote controller.
Remote Controller	Does remote controller show the humidity information (Status) as well?	Yes. It shows the current humidity information on screen. (for RS3 Only) But has no function to control the humidity
Remote Controller	Is it possible to connect the local humidity sensor with Remote controller (RS3)?	No. All of RS3 remote controller can not be connected with local humidity sensor.
SLC	Does dual sensing SLC function control the humidity ratio?	No. There is no control of humidity ratio.
SLC	Is SLC fully used on Eurovent? Isn't humidity fixed for the test? What about AHRI?	Eurovent (RH 47%) and AHRI (RH 51%) have fixed humidity test condition.
Comfort Cooling	Why is not the comfort heating applied in product?	Comfort cooling need super heating controlled and Comfort heating need sub cooling controlled. In case of controlling EEV for sub cooling, noise and stable operation may be affected and critical.
Installation	Does the IDU – Central controller direct connection for communication cable is possible? (Flat connection)	No, it is not possible.

MULTI V 5

ARUM080LTE5 / ARUM100LTE5
ARUM120LTE5 / ARUM140LTE5



LG participates in the ECP programme for EUROVENT VRF program. Check ongoing validity of certification : www.eurovent-certification.com

HP		8	10	12	14
Model Name	Combination Unit	ARUM080LTE5	ARUM100LTE5	ARUM120LTE5	ARUM140LTE5
	Independent Unit	ARUM080LTE5	ARUM100LTE5	ARUM120LTE5	ARUM140LTE5
Capacity	Cooling (Rated) kW	22.4	28.0	33.6	39.2
	Heating (Rated) kW	22.4	28.0	33.6	39.2
	Heating (Max) kW	25.2	31.5	37.8	44.1
	Cooling (Rated) kW	4.49	5.80	7.58	8.68
Input	Heating (Rated) kW	3.97	4.92	6.85	8.13
	Heating (Max) kW	4.78	5.92	8.26	9.72
	EER	4.99	4.83	4.43	4.52
SEER		10.1	9.7	9.59	8.89
COP	Rated Capacity	5.64	5.69	4.91	4.82
	Max Capacity	5.27	5.32	4.58	4.54
SCOP		4.69	4.51	5.01	4.63
Exterior	Color	Warm Gray / Dawn Gray	Warm Gray / Dawn Gray	Warm Gray / Dawn Gray	Warm Gray / Dawn Gray
	RAL Code (Classic)	RAL 7044 / RAL 7037	RAL 7044 / RAL 7037	RAL 7044 / RAL 7037	RAL 7044 / RAL 7037
Heat Exchanger	Type	Wide Louver Plus / Black Fin	Wide Louver Plus / Black Fin	Wide Louver Plus / Black Fin	Wide Louver Plus / Black Fin
	Type	Hermetically Sealed Scroll	Hermetically Sealed Scroll	Hermetically Sealed Scroll	Hermetically Sealed Scroll
Compressor	Combination x No.	(Inverter) x 1	(Inverter) x 1	(Inverter) x 1	(Inverter) x 1
	Motor Output x Number	W x No.	4,200 x 1	5,300 x 1	5,300 x 1
	Oil Type		FVC68D (PVE)	FVC68D (PVE)	FVC68D (PVE)
	Oil Charge	cc	3,900	3,900	3,900
	Type		Propeller fan	Propeller fan	Propeller fan
Fan	Motor Output x Number	W x No.	1,200 x 1	1,200 x 1	900 x 2
	Air Flow Rate (High)	m ³ /minxNo.	240 x 1	240 x 1	240 x 1
	Drive		DC INVERTER	DC INVERTER	DC INVERTER
	Discharge	Side / Top	TOP	TOP	TOP
	Pipe Connections for Heat Recovery	Liquid Pipe	mm (inch)	Ø9.52 (3/8)	Ø9.52 (3/8)
Pipe Connections for Heat Pump	Low Pressure Gas Pipe	mm (inch)	Ø19.05 (3/4)	Ø22.2 (7/8)	Ø28.58 (1-1/8)
	High Pressure Gas Pipe	mm (inch)	Ø15.88 (5/8)	Ø19.05 (3/4)	Ø22.2 (7/8)
Dimensions (W x H x D)	Liquid Pipe	mm (inch)	Ø9.52 (3/8)	Ø9.52 (3/8)	Ø12.7 (1/2)
	Gas Pipe	mm (inch)	Ø19.05 (3/4)	Ø22.2 (7/8)	Ø28.58 (1-1/8)
Dimensions (W x H x D) - Shipping	mm x No.	(930 x 1,690 x 760) x 1	(930 x 1,690 x 760) x 1	(930 x 1,690 x 760) x 1	(1,240 x 1,690 x 760) x 1
Net Weight	mm x No.	(960 x 1,825 x 796) x 1	(960 x 1,825 x 796) x 1	(960 x 1,825 x 796) x 1	(1,280 x 1,825 x 796) x 1
Shipping Weight	kg x No.	198 x 1	215 x 1	215 x 1	237 x 1
Sound Pressure Level	Cooling	kg x No.	208 x 1	225 x 1	225 x 1
	Heating	kg x No.	208 x 1	225 x 1	225 x 1
Sound Power Level	Cooling	kg x No.	208 x 1	225 x 1	225 x 1
	Heating	kg x No.	208 x 1	225 x 1	225 x 1
Communication Cable	Cooling	kg x No.	208 x 1	225 x 1	225 x 1
	Heating	kg x No.	208 x 1	225 x 1	225 x 1
Refrigerant	mm ² x No. (VCTF-SB)	mm ² x No. (VCTF-SB)	1.0 - 1.5 x 2C	1.0 - 1.5 x 2C	1.0 - 1.5 x 2C
	Refrigerant Name		R410A	R410A	R410A
	Precharged Amount in Factory	kg	7.5	9.5	9.5
	t-CO ₂ eq		15.7	19.8	19.8
Power Supply	Control		Electronic Expansion Valve	Electronic Expansion Valve	Electronic Expansion Valve
Number of Maximum Connectable Indoor Units ¹⁾	Ø, V, Hz	3, 380-415, 50	3, 380-415, 50	3, 380-415, 50	3, 380-415, 50

1) Maximum numbers are prepared based on assumption that all 2.2kW indoor units are connected. The numbers in parentheses means maximum connectable indoor units in accordance with outdoor units combination (160% - 200%). The recommended ratio is 130%.

MULTI V 5

ARUM160LTE5 / ARUM180LTE5
ARUM200LTE5 / ARUM220LTE5



LG participates in the ECP programme for EUROVENT VRF program. Check ongoing validity of certification : www.eurovent-certification.com

HP		16	18	20	22
Model Name	Combination Unit	ARUM160LTE5	ARUM180LTE5	ARUM200LTE5	ARUM220LTE5
	Independent Unit	ARUM160LTE5	ARUM180LTE5	ARUM200LTE5	ARUM220LTE5
Capacity	Cooling (Rated) kW	44.8	50.4	56.0	61.6
	Heating (Rated) kW	44.8	50.4	56.0	61.6
	Heating (Max) kW	50.4	56.7	63.0	69.3
	Cooling (Rated) kW	10.89	10.91	12.77	15.70
Input	Heating (Rated) kW	10.28	10.12	12.20	14.15
	Heating (Max) kW	12.39	11.94	14.69	16.76
	EER	4.11	4.62	4.39	3.92
SEER		8.38	8.23	8.05	7.51
COP	Rated Capacity	4.36	4.98	4.59	4.35
	Max Capacity	4.07	4.75	4.29	4.13
SCOP		4.83	4.0	3.98	3.9
Exterior	Color	Warm Gray / Dawn Gray	Warm Gray / Dawn Gray	Warm Gray / Dawn Gray	Warm Gray / Dawn Gray
	RAL Code (Classic)	RAL 7044 / RAL 7037	RAL 7044 / RAL 7037	RAL 7044 / RAL 7037	RAL 7044 / RAL 7037
Heat Exchanger	Type	Wide Louver Plus / Black Fin	Wide Louver Plus / Black Fin	Wide Louver Plus / Black Fin	Wide Louver Plus / Black Fin
	Type	Hermetically Sealed Scroll	Hermetically Sealed Scroll	Hermetically Sealed Scroll	Hermetically Sealed Scroll
Compressor	Combination x No.	(Inverter) x 1	(Inverter) x 2	(Inverter) x 2	(Inverter) x 2
	Motor Output x Number	W x No.	5,300 x 1	(5,300 x 1) + (4,200 x 1)	(5,300 x 1) + (4,200 x 1)
	Oil Type		FVC68D (PVE)	FVC68D (PVE)	FVC68D (PVE)
	Oil Charge	cc	3,900	5,200	5,200
	Type		Propeller fan	Propeller fan	Propeller fan
Fan	Motor Output x Number	W x No.	900 x 2	900 x 2	900 x 2
	Air Flow Rate (High)	m ³ /minxNo.	320 x 1	320 x 1	320 x 1
	Drive		DC INVERTER	DC INVERTER	DC INVERTER
	Discharge	Side / Top	TOP	TOP	TOP
	Pipe Connections for Heat Recovery	Liquid Pipe	mm (inch)	Ø12.7 (1/2)	Ø15.88 (5/8)
Pipe Connections for Heat Pump	Low Pressure Gas Pipe	mm (inch)	Ø28.58 (1-1/8)	Ø28.58 (1-1/8)	Ø28.58 (1-1/8)
	High Pressure Gas Pipe	mm (inch)	Ø22.2 (7/8)	Ø22.2 (7/8)	Ø28.58 (1-1/8)
Dimensions (W x H x D)	Liquid Pipe	mm (inch)	Ø12.7 (1/2)	Ø15.88 (5/8)	Ø15.88 (5/8)
	Gas Pipe	mm (inch)	Ø28.58 (1-1/8)	Ø28.58 (1-1/8)	Ø28.58 (1-1/8)
Dimensions (W x H x D) - Shipping	mm x No.	(1,240 x 1,690 x 760) x 1	(1,240 x 1,690 x 760) x 1	(1,240 x 1,690 x 760) x 1	(1,240 x 1,690 x 760) x 1
Net Weight	mm x No.	(1,280 x 1,825 x 796) x 1	(1,280 x 1,825 x 796) x 1	(1,280 x 1,825 x 796) x 1	(1,280 x 1,825 x 796) x 1
Shipping Weight	kg x No.	237 x 1	300 x 1	300 x 1	300 x 1
Sound Pressure Level	Cooling	kg x No.	250 x 1	312 x 1	312 x 1
	Heating	kg x No.	250 x 1	312 x 1	312 x 1
Sound Power Level	Cooling	kg x No.	250 x 1	312 x 1	312 x 1
	Heating	kg x No.	250 x 1	312 x 1	312 x 1
Communication Cable	mm ² x No. (VCTF-SB)	mm ² x No. (VCTF-SB)	1.0 - 1.5 x 2C	1.0 - 1.5 x 2C	1.0 - 1.5 x 2C
	Refrigerant Name		R410A	R410A	R410A
Refrigerant	Precharged Amount in Factory	kg	13.5	16.0	16.0
	t-CO ₂ eq		28.2	33.4	33.4
	Control		Electronic Expansion Valve	Electronic Expansion Valve	Electronic Expansion Valve
	Power Supply	Ø, V, Hz	3, 380-415, 50	3, 380-415, 50	3, 380-415, 50
Number of Maximum Connectable Indoor Units ¹⁾		26 (40)	29 (45)	32 (50)	

1) Maximum numbers are prepared based on assumption that all 2.2kW indoor units are connected. The numbers in parentheses means maximum connectable indoor units in accordance with outdoor units combination (160% - 200%). The recommended ratio is 130%.

MULTI V 5

ARUM240LTE5 / ARUM260LTE5
ARUM221LTE5 / ARUM241LTE5



LG participates in the ECP programme for EUROVENT VRF program. Check ongoing validity of certification : www.eurovent-certification.com

HP			24	26	22'	24'
Model Name	Combination Unit		ARUM240LTE5	ARUM260LTE5	ARUM221LTE5	ARUM241LTE5
	Independent Unit		ARUM240LTE5	ARUM260LTE5	ARUM120LTE5 ARUM100LTE5	ARUM120LTE5 ARUM120LTE5
Capacity	Cooling (Rated)	kW	67.2	72.8	61.6	67.2
	Heating (Rated)	kW	67.2	67.2	61.6	67.2
	Heating (Max)	kW	74.3	74.3	69.3	75.6
Input	Cooling (Rated)	kW	17.40	20.20	13.38	15.16
	Heating (Rated)	kW	15.89	15.99	11.77	13.70
	Heating (Max)	kW	18.80	19.15	14.18	16.52
EER			3.86	3.60	4.60	4.43
SEER			7.88	7.55	-	-
COP	Rated Capacity		4.23	4.20	5.23	4.91
	Max Capacity		3.95	3.88	4.89	4.58
SCOP			4.34	4.34	-	-
Exterior	Color		Warm Gray / Dawn Gray	Warm Gray / Dawn Gray	Warm Gray / Dawn Gray	Warm Gray / Dawn Gray
	RAL Code (Classic)		RAL 7044 / RAL 7037	RAL 7044 / RAL 7037	RAL 7044 / RAL 7037	RAL 7044 / RAL 7037
Heat Exchanger	Type		Wide Louver Plus / Black Fin	Wide Louver Plus / Black Fin	Wide Louver Plus / Black Fin	Wide Louver Plus / Black Fin
	Type		Hermetically Sealed Scroll	Hermetically Sealed Scroll	Hermetically Sealed Scroll	Hermetically Sealed Scroll
Compressor	Combination x No.		(Inverter) x 2	(Inverter) x 2	(Inverter) x 2	(Inverter) x 2
	Motor Output x Number	W x No.	5,300 x 2	5,300 x 2	5,300 x 2	5,300 x 2
	Oil Type		FVC68D (PVE)	FVC68D (PVE)	FVC68D (PVE)	FVC68D (PVE)
Oil Charge	cc		5,200	5,200	7,800	7,800
	Type		Propeller fan	Propeller fan	Propeller fan	Propeller fan
Fan	Motor Output x Number	W x No.	900 x 2	900 x 2	(1,200 x 1) + (1,200 x 1)	(1,200 x 1) + (1,200 x 1)
	Air Flow Rate (High)	m³/min x No.	320 x 1	320 x 1	(240 x 1) + (240 x 1)	(240 x 1) + (240 x 1)
	Drive		DC INVERTER	DC INVERTER	DC INVERTER	DC INVERTER
Discharge	Side / Top		TOP	TOP	TOP	TOP
	Liquid Pipe	mm (inch)	Ø15.88 (5/8)	Ø19.05 (3/4)	Ø15.88 (5/8)	Ø15.88 (5/8)
Pipe Connections for Heat Recovery	Low Pressure Gas Pipe	mm (inch)	Ø34.9 (1-3/8)	Ø34.9 (1-3/8)	Ø28.58 (1-1/8)	Ø34.9 (1-3/8)
	High Pressure Gas Pipe	mm (inch)	Ø28.58 (1-1/8)	Ø28.58 (1-1/8)	Ø28.58 (1-1/8)	Ø28.58 (1-1/8)
Pipe Connections for Heat Pump	Liquid Pipe	mm (inch)	Ø15.88 (5/8)	Ø19.05 (3/4)	Ø15.88 (5/8)	Ø15.88 (5/8)
	Gas Pipe	mm (inch)	Ø34.9 (1-3/8)	Ø34.9 (1-3/8)	Ø28.58 (1-1/8)	Ø34.9 (1-3/8)
Dimensions (W x H x D)	mm x No.		(1,240 x 1,690 x 760) x 1	(1,240 x 1,690 x 760) x 1	(930 x 1,690 x 760) x 1 + (930 x 1,690 x 760) x 1	(930 x 1,690 x 760) x 1 + (930 x 1,690 x 760) x 1
Dimensions (W x H x D) - Shipping	mm x No.		(1,280 x 1,825 x 796) x 1	(1,280 x 1,825 x 796) x 1	(960 x 1,825 x 796) x 1 + (960 x 1,825 x 796) x 1	(960 x 1,825 x 796) x 1 + (960 x 1,825 x 796) x 1
Net Weight	kg x No.		310 x 1	310 x 1	(215 x 1) + (215 x 1)	(215 x 1) + (215 x 1)
Shipping Weight	kg x No.		320 x 1	320 x 1	(225 x 1) + (225 x 1)	(225 x 1) + (225 x 1)
Sound Pressure Level	Cooling	dB(A)	65.0	65.0	61.5	62.0
	Heating	dB(A)	67.0	67.0	62.5	63.0
Sound Power Level	Cooling	dB(A)	95.0	95.0	88.5	89.0
	Heating	dB(A)	99.0	99.0	91.5	92.0
Communication Cable	mm² x No. (VCTF-SB)		1.0 - 1.5 x 2C	1.0 - 1.5 x 2C	1.0 - 1.5 x 2C	1.0 - 1.5 x 2C
Refrigerant	Refrigerant Name		R410A	R410A	R410A	R410A
	Precharged Amount in Factory	kg	17.0	17.0	19.0	19.0
	t-CO ₂ eq		35.5	35.5	39.7	39.7
	Control		Electronic Expansion Valve	Electronic Expansion Valve	Electronic Expansion Valve	Electronic Expansion Valve
Power Supply	Ø, V, Hz		3, 380-415, 50	3, 380-415, 50	3, 380-415, 50	3, 380-415, 50
Number of Maximum Connectable Indoor Units ¹⁾			39 (61)	42 (64)	35 (44)	39 (48)

1) Maximum numbers are prepared based on assumption that all 2.2kW indoor units are connected. The numbers in parentheses means maximum connectable indoor units in accordance with outdoor units combination (160% - 200%). The recommended ratio is 130%.

MULTI V 5

ARUM261LTE5 / ARUM280LTE5
ARUM300LTE5 / ARUM320LTE5



LG participates in the ECP programme for EUROVENT VRF program. Check ongoing validity of certification : www.eurovent-certification.com

HP			26'	28	30	32
Model Name	Combination Unit		ARUM261LTE5	ARUM280LTE5	ARUM300LTE5	ARUM320LTE5
	Independent Unit		ARUM140LTE5 ARUM120LTE5	ARUM160LTE5 ARUM120LTE5	ARUM180LTE5 ARUM120LTE5	ARUM200LTE5 ARUM120LTE5
Capacity	Cooling (Rated)	kW	72.8	78.4	84.0	89.6
	Heating (Rated)	kW	72.8	78.4	84.0	89.6
	Heating (Max)	kW	81.9	88.2	94.5	100.8
Input	Cooling (Rated)	kW	16.26	18.47	18.49	20.35
	Heating (Rated)	kW	14.98	17.13	16.97	19.05
	Heating (Max)	kW	17.98	20.65	20.20	22.95
EER			4.48	4.24	4.54	4.40
SEER			-	-	-	-
COP	Rated Capacity		4.86	4.58	4.95	4.70
	Max Capacity		4.56	4.27	4.68	4.39
SCOP			-	-	-	-
Exterior	Color		Warm Gray / Dawn Gray	Warm Gray / Dawn Gray	Warm Gray / Dawn Gray	Warm Gray / Dawn Gray
	RAL Code (Classic)		RAL 7044 / RAL 7037	RAL 7044 / RAL 7037	RAL 7044 / RAL 7037	RAL 7044 / RAL 7037
Heat Exchanger	Type		Wide Louver Plus / Black Fin	Wide Louver Plus / Black Fin	Wide Louver Plus / Black Fin	Wide Louver Plus / Black Fin
	Type		Hermetically Sealed Scroll	Hermetically Sealed Scroll	Hermetically Sealed Scroll	Hermetically Sealed Scroll
Compressor	Combination x No.		(Inverter) x 2	(Inverter) x 2	(Inverter) x 3	(Inverter) x 3
	Motor Output x Number	W x No.	5,300 x 2	5,300 x 2	(5,300 x 2) + (4,200 x 1)	(5,300 x 2) + (4,200 x 1)
	Oil Type		FVC68D (PVE)	FVC68D (PVE)	FVC68D (PVE)	FVC68D (PVE)
Oil Charge	cc		7,800	7,800	9,100	9,100
	Type		Propeller fan	Propeller fan	Propeller fan	Propeller fan
Fan	Motor Output x Number	W x No.	(900 x 2) + (1,200 x 1)	(900 x 2) + (1,200 x 1)	(900 x 2) + (1,200 x 1)	(900 x 2) + (1,200 x 1)
	Air Flow Rate (High)	m³/min x No.	(320 x 1) + (240 x 1)	(320 x 1) + (240 x 1)	(320 x 1) + (240 x 1)	(320 x 1) + (240 x 1)
	Drive		DC INVERTER	DC INVERTER	DC INVERTER	DC INVERTER
Discharge	Side / Top		TOP	TOP	TOP	TOP
	Liquid Pipe	mm (inch)	Ø19.05 (3/4)	Ø19.05 (3/4)	Ø19.05 (3/4)	Ø19.05 (3/4)
Pipe Connections for Heat Recovery	Low Pressure Gas Pipe	mm (inch)	Ø34.9 (1-3/8)	Ø34.9 (1-3/8)	Ø34.9 (1-3/8)	Ø34.9 (1-3/8)
	High Pressure Gas Pipe	mm (inch)	Ø28.58 (1-1/8)	Ø28.58 (1-1/8)	Ø28.58 (1-1/8)	Ø28.58 (1-1/8)
Pipe Connections for Heat Pump	Liquid Pipe	mm (inch)	Ø19.05 (3/4)	Ø19.05 (3/4)	Ø19.05 (3/4)	Ø19.05 (3/4)
	Gas Pipe	mm (inch)	Ø34.9 (1-3/8)	Ø34.9 (1-3/8)	Ø34.9 (1-3/8)	Ø34.9 (1-3/8)
Dimensions (W x H x D)	mm x No.		(1,240 x 1,690 x 760) x 1 + (930 x 1,690 x 760) x 1	(1,240 x 1,690 x 760) x 1 + (930 x 1,690 x 760) x 1	(1,240 x 1,690 x 760) x 1 + (930 x 1,690 x 760) x 1	(1,240 x 1,690 x 760) x 1 + (930 x 1,690 x 760) x 1
Dimensions (W x H x D) - Shipping	mm x No.		(1,280 x 1,825 x 796) x 1 + (960 x 1,825 x 796) x 1	(1,280 x 1,825 x 796) x 1 + (960 x 1,825 x 796) x 1	(1,280 x 1,825 x 796) x 1 + (960 x 1,825 x 796) x 1	(1,280 x 1,825 x 796) x 1 + (960 x 1,825 x 796) x 1
Net Weight	kg x No.		(237 x 1) + (215 x 1)	(237 x 1) + (215 x 1)	(300 x 1) + (215 x 1)	(300 x 1) + (215 x 1)
Shipping Weight	kg x No.		(250 x 1) + (225 x 1)	(250 x 1) + (225 x 1)	(312 x 1) + (225 x 1)	(312 x 1) + (225 x 1)
Sound Pressure Level	Cooling	dB(A)	62.5	62.8	63.1	63.8
	Heating	dB(A)	63.5	63.8	64.1	65.8
Sound Power Level	Cooling	dB(A)	90.8	91.5	93.0	93.8
	Heating	dB(A)	94.5	95.2	96.0	96.8
Communication Cable	mm² x No. (VCTF-SB)		1.0 - 1.5 x 2C	1.0 - 1.5 x 2C	1.0 - 1.5 x 2C	1.0 - 1.5 x 2C
Refrigerant	Refrigerant Name		R410A	R410A	R410A	R410A
	Precharged Amount in Factory	kg	23.0	23.0	25.5	25.5
	t-CO ₂ eq		48.0	48.0	53.2	53.2
	Control		Electronic Expansion Valve	Electronic Expansion Valve	Electronic Expansion Valve	Electronic Expansion Valve
Power Supply	Ø, V, Hz		3, 380-415, 50	3, 380-415, 50	3, 380-415, 50	3, 380-415, 50
Number of Maximum Connectable Indoor Units ¹⁾			42 (52)	45 (56)	49 (60)	52 (64)

1) Maximum numbers are prepared based on assumption that all 2.2kW indoor units are connected. The numbers in parentheses means maximum connectable indoor units in accordance with outdoor units combination (160% - 200%). The recommended ratio is 130%.

MULTI V 5

ARUM340LTE5 / ARUM360LTE5
ARUM380LTE5 / ARUM400LTE5



HP		34	36	38	40
Model Name	Combination Unit	ARUM340LTE5	ARUM360LTE5	ARUM380LTE5	ARUM400LTE5
	Independent Unit	ARUM220LTE5 ARUM120LTE5	ARUM240LTE5 ARUM120LTE5	ARUM240LTE5 ARUM140LTE5	ARUM240LTE5 ARUM160LTE5
Capacity	Cooling (Rated) kW	95.2	100.8	106.4	112.0
	Heating (Rated) kW	95.2	100.8	106.4	112.0
	Heating (Max) kW	107.1	112.1	118.4	124.7
Input	Cooling (Rated) kW	23.28	24.98	26.08	28.29
	Heating (Rated) kW	21.00	22.74	24.02	26.17
	Heating (Max) kW	25.02	27.06	28.52	31.19
EER		4.09	4.04	4.08	3.96
SEER		-	-	-	-
COP	Rated Capacity	4.53	4.43	4.43	4.28
	Max Capacity	4.28	4.14	4.15	4.00
SCOP		-	-	-	-
Exterior	Color	Warm Gray / Dawn Gray	Warm Gray / Dawn Gray	Warm Gray / Dawn Gray	Warm Gray / Dawn Gray
	RAL Code (Classic)	RAL 7044 / RAL 7037	RAL 7044 / RAL 7037	RAL 7044 / RAL 7037	RAL 7044 / RAL 7037
Heat Exchanger	Type	Wide Louver Plus / Black Fin	Wide Louver Plus / Black Fin	Wide Louver Plus / Black Fin	Wide Louver Plus / Black Fin
	Type	Hermetically Sealed Scroll	Hermetically Sealed Scroll	Hermetically Sealed Scroll	Hermetically Sealed Scroll
Compressor	Combination x No.	(Inverter) x 3	(Inverter) x 3	(Inverter) x 3	(Inverter) x 3
	Motor Output x Number	W x No.	(5,300 x 2) + (4,200 x 1)	5,300 x 3	5,300 x 3
	Oil Type		FVC68D (PVE)	FVC68D (PVE)	FVC68D (PVE)
	Oil Charge	cc	9,100	9,100	9,100
Fan	Type		Propeller fan	Propeller fan	Propeller fan
	Motor Output x Number	W x No.	(900 x 2) + (1,200 x 1)	(900 x 2) + (1,200 x 1)	900 x 4
	Air Flow Rate (High)	m³/min x No.	(320 x 1) + (240 x 1)	(320 x 1) + (240 x 1)	320 x 2
	Drive		DC INVERTER	DC INVERTER	DC INVERTER
	Discharge	Side / Top	TOP	TOP	TOP
Pipe Connections for Heat Recovery	Liquid Pipe	mm (inch)	Ø19.05 (3/4)	Ø19.05 (3/4)	Ø19.05 (3/4)
	Low Pressure Gas Pipe	mm (inch)	Ø34.9 (1-3/8)	Ø41.3 (1-5/8)	Ø41.3 (1-5/8)
	High Pressure Gas Pipe	mm (inch)	Ø28.58 (1-1/8)	Ø28.58 (1-1/8)	Ø34.9 (1-3/8)
Pipe Connections for Heat Pump	Liquid Pipe	mm (inch)	Ø19.05 (3/4)	Ø19.05 (3/4)	Ø19.05 (3/4)
	Gas Pipe	mm (inch)	Ø34.9 (1-3/8)	Ø41.3 (1-5/8)	Ø41.3 (1-5/8)
Dimensions (W x H x D)	mm x No.	(1,240 x 1,690 x 760) x 1 + (930 x 1,690 x 760) x 1	(1,240 x 1,690 x 760) x 1 + (930 x 1,690 x 760) x 1	(1,240 x 1,690 x 760) x 2	(1,240 x 1,690 x 760) x 2
Dimensions (W x H x D) - Shipping	mm x No.	(1,280 x 1,825 x 796) x 1 + (960 x 1,825 x 796) x 1	(1,280 x 1,825 x 796) x 1 + (960 x 1,825 x 796) x 1	(1,280 x 1,825 x 796) x 2	(1,280 x 1,825 x 796) x 2
Net Weight	kg x No.	(300 x 1) + (215 x 1)	(310 x 1) + (215 x 1)	(310 x 1) + (237 x 1)	(310 x 1) + (237 x 1)
Shipping Weight	kg x No.	(312 x 1) + (225 x 1)	(320 x 1) + (225 x 1)	(320 x 1) + (250 x 1)	(320 x 1) + (250 x 1)
Sound Pressure Level	Cooling	dB(A)	65.6	66.0	66.2
	Heating	dB(A)	66.6	67.8	68.0
Sound Power Level	Cooling	dB(A)	93.8	95.5	96.0
	Heating	dB(A)	97.6	99.4	100.0
Communication Cable	mm² x No. (VCTF-SB)	1.0 - 1.5 x 2C	1.0 - 1.5 x 2C	1.0 - 1.5 x 2C	1.0 - 1.5 x 2C
Refrigerant	Refrigerant Name		R410A	R410A	R410A
	Precharged Amount in Factory	kg	25.5	26.5	30.5
	t-CO ₂ ,eq		53.2	55.3	63.7
	Control		Electronic Expansion Valve	Electronic Expansion Valve	Electronic Expansion Valve
Power Supply	Ø, V, Hz	3, 380-415, 50	3, 380-415, 50	3, 380-415, 50	3, 380-415, 50
Number of Maximum Connectable Indoor Units¹⁾		55 (64)	58 (64)	61 (64)	64

1) Maximum numbers are prepared based on assumption that all 2.2kW indoor units are connected. The numbers in parentheses means maximum connectable indoor units in accordance with outdoor units combination (160% - 200%). The recommended ratio is 130%.

MULTI V 5

ARUM420LTE5 / ARUM440LTE5
ARUM460LTE5 / ARUM480LTE5



HP		42	44	46	48
Model Name	Combination Unit	ARUM420LTE5	ARUM440LTE5	ARUM460LTE5	ARUM480LTE5
	Independent Unit	ARUM240LTE5 ARUM180LTE5	ARUM240LTE5 ARUM200LTE5	ARUM240LTE5 ARUM220LTE5	ARUM240LTE5 ARUM240LTE5
Capacity	Cooling (Rated) kW	117.6	123.2	128.8	134.4
	Heating (Rated) kW	117.6	123.2	128.8	134.4
	Heating (Max) kW	131.0	137.3	143.6	148.5
Input	Cooling (Rated) kW	28.31	30.17	33.10	34.80
	Heating (Rated) kW	26.01	28.09	30.04	31.78
	Heating (Max) kW	30.74	33.48	35.56	37.60
EER		4.15	4.08	3.89	3.86
SEER		-	-	-	-
COP	Rated Capacity	4.52	4.39	4.29	4.23
	Max Capacity	4.26	4.10	4.04	3.95
SCOP		-	-	-	-
Exterior	Color	Warm Gray / Dawn Gray	Warm Gray / Dawn Gray	Warm Gray / Dawn Gray	Warm Gray / Dawn Gray
	RAL Code (Classic)	RAL 7044 / RAL 7037	RAL 7044 / RAL 7037	RAL 7044 / RAL 7037	RAL 7044 / RAL 7037
Heat Exchanger	Type	Wide Louver Plus / Black Fin	Wide Louver Plus / Black Fin	Wide Louver Plus / Black Fin	Wide Louver Plus / Black Fin
	Type	Hermetically Sealed Scroll	Hermetically Sealed Scroll	Hermetically Sealed Scroll	Hermetically Sealed Scroll
Compressor	Combination x No.	(Inverter) x 4	(Inverter) x 4	(Inverter) x 4	(Inverter) x 4
	Motor Output x Number	W x No.	(5,300 x 3) + (4,200 x 1)	(5,300 x 3) + (4,200 x 1)	(5,300 x 3) + (4,200 x 1)
	Oil Type		FVC68D (PVE)	FVC68D (PVE)	FVC68D (PVE)
	Oil Charge	cc	10,400	10,400	10,400
Fan	Type		Propeller fan	Propeller fan	Propeller fan
	Motor Output x Number	W x No.	900 x 4	900 x 4	900 x 4
	Air Flow Rate (High)	m³/min x No.	320 x 2	320 x 2	320 x 2
	Drive		DC INVERTER	DC INVERTER	DC INVERTER
	Discharge	Side / Top	TOP	TOP	TOP
Pipe Connections for Heat Recovery	Liquid Pipe	mm (inch)	Ø19.05 (3/4)	Ø19.05 (3/4)	Ø19.05 (3/4)
	Low Pressure Gas Pipe	mm (inch)	Ø41.3 (1-5/8)	Ø41.3 (1-5/8)	Ø41.3 (1-5/8)
	High Pressure Gas Pipe	mm (inch)	Ø34.9 (1-3/8)	Ø34.9 (1-3/8)	Ø34.9 (1-3/8)
Pipe Connections for Heat Pump	Liquid Pipe	mm (inch)	Ø19.05 (3/4)	Ø19.05 (3/4)	Ø19.05 (3/4)
	Gas Pipe	mm (inch)	Ø41.3 (1-5/8)	Ø41.3 (1-5/8)	Ø41.3 (1-5/8)
Dimensions (W x H x D)	mm x No.	(1,240 x 1,690 x 760) x 2	(1,240 x 1,690 x 760) x 2	(1,240 x 1,690 x 760) x 2	(1,240 x 1,690 x 760) x 2
Dimensions (W x H x D) - Shipping	mm x No.	(1,280 x 1,825 x 796) x 2	(1,280 x 1,825 x 796) x 2	(1,280 x 1,825 x 796) x 2	(1,280 x 1,825 x 796) x 2
Net Weight	kg x No.	(310 x 1) + (300 x 1)	(310 x 1) + (300 x 1)	(310 x 1) + (300 x 1)	310 x 2
Shipping Weight	kg x No.	(320 x 1) + (312 x 1)	(320 x 1) + (312 x 1)	(320 x 1) + (312 x 1)	320 x 2
Sound Pressure Level	Cooling	dB(A)	66.5	66.8	67.8
	Heating	dB(A)	68.2	68.9	69.3
Sound Power Level	Cooling	dB(A)	96.8	97.1	98.0
	Heating	dB(A)	100.5	100.8	101.1
Communication Cable	mm² x No. (VCTF-SB)	1.0 - 1.5 x 2C	1.0 - 1.5 x 2C	1.0 - 1.5 x 2C	1.0 - 1.5 x 2C
Refrigerant	Refrigerant Name		R410A	R410A	R410A
	Precharged Amount in Factory	kg	33.0	33.0	34.0
	t-CO ₂ ,eq		68.9	68.9	71.0
	Control		Electronic Expansion Valve	Electronic Expansion Valve	Electronic Expansion Valve
Power Supply	Ø, V, Hz	3, 380-415, 50	3, 380-415, 50	3, 380-415, 50	3, 380-415, 50
Number of Maximum Connectable Indoor Units¹⁾		64	64	64	64

1) Maximum numbers are prepared based on assumption that all 2.2kW indoor units are connected. The numbers in parentheses means maximum connectable indoor units in accordance with outdoor units combination (160% - 200%). The recommended ratio is 130%.

MULTI V 5

ARUM500LTE5 / ARUM520LTE5
ARUM540LTE5 / ARUM560LTE5



HP		50	52	54	56	
Model Name	Combination Unit	ARUM500LTE5	ARUM520LTE5	ARUM540LTE5	ARUM560LTE5	
	Independent Unit	ARUM240LTE5 ARUM140LTE5 ARUM120LTE5	ARUM240LTE5 ARUM160LTE5 ARUM120LTE5	ARUM240LTE5 ARUM180LTE5 ARUM120LTE5	ARUM240LTE5 ARUM200LTE5 ARUM120LTE5	
Capacity	Cooling (Rated) kW	140	145.6	151.2	156.8	
	Heating (Rated) kW	140	145.6	151.2	156.8	
	Heating (Max) kW	156.2	162.5	168.8	175.1	
Input	Cooling (Rated) kW	33.66	35.87	35.89	37.75	
	Heating (Rated) kW	30.87	33.02	32.86	34.94	
	Heating (Max) kW	36.78	39.45	39	41.74	
EER		4.16	4.06	4.21	4.15	
SEER		-	-	-	-	
COP	Rated Capacity	4.54	4.41	4.6	4.49	
	Max Capacity	4.25	4.12	4.33	4.19	
SCOP		-	-	-	-	
Exterior	Color	Warm Gray / Dawn Gray	Warm Gray / Dawn Gray	Warm Gray / Dawn Gray	Warm Gray / Dawn Gray	
	RAL Code (Classic)	RAL 7044 / RAL 7037	RAL 7044 / RAL 7037	RAL 7044 / RAL 7037	RAL 7044 / RAL 7037	
Heat Exchanger	Type	Wide Louver Plus / Black Fin	Wide Louver Plus / Black Fin	Wide Louver Plus / Black Fin	Wide Louver Plus / Black Fin	
	Type	Hermetically Sealed Scroll	Hermetically Sealed Scroll	Hermetically Sealed Scroll	Hermetically Sealed Scroll	
Compressor	Combination x No.	(Inverter) x 4	(Inverter) x 4	(Inverter) x 5	(Inverter) x 5	
	Motor Output x Number	W x No.	5,300 x 4	5,300 x 4	(5,300 x 4) + (4,200 x 1)	(5,300 x 4) + (4,200 x 1)
	Oil Type		FVC68D (PVE)	FVC68D (PVE)	FVC68D (PVE)	FVC68D (PVE)
	Oil Charge	cc	13,000	13,000	14,300	14,300
	Type		Propeller fan	Propeller fan	Propeller fan	Propeller fan
Fan	Motor Output x Number	W x No.	(900 x 4) + (1,200 x 1)	(900 x 4) + (1,200 x 1)	(900 x 4) + (1,200 x 1)	(900 x 4) + (1,200 x 1)
	Air Flow Rate (High)	m³/min x No.	(320 x 2) + (240 x 1)	(320 x 2) + (240 x 1)	(320 x 2) + (240 x 1)	(320 x 2) + (240 x 1)
	Drive		DC INVERTER	DC INVERTER	DC INVERTER	DC INVERTER
	Discharge	Side / Top	TOP	TOP	TOP	TOP
Pipe Connections for Heat Recovery	Liquid Pipe	mm (inch)	Ø19.05 (3/4)	Ø19.05 (3/4)	Ø19.05 (3/4)	Ø19.05 (3/4)
	Low Pressure Gas Pipe	mm (inch)	Ø41.3 (1-5/8)	Ø41.3 (1-5/8)	Ø41.3 (1-5/8)	Ø41.3 (1-5/8)
	High Pressure Gas Pipe	mm (inch)	Ø34.9 (1-3/8)	Ø34.9 (1-3/8)	Ø34.9 (1-3/8)	Ø34.9 (1-3/8)
Pipe Connections for Heat Pump	Liquid Pipe	mm (inch)	Ø19.05 (3/4)	Ø19.05 (3/4)	Ø19.05 (3/4)	Ø19.05 (3/4)
	Gas Pipe	mm (inch)	Ø41.3 (1-5/8)	Ø41.3 (1-5/8)	Ø41.3 (1-5/8)	Ø41.3 (1-5/8)
Dimensions (W x H x D)	mm x No.	(1,240 x 1,690 x 760) x 2 + (930 x 1,690 x 760) x 1	(1,240 x 1,690 x 760) x 2 + (930 x 1,690 x 760) x 1	(1,240 x 1,690 x 760) x 2 + (930 x 1,690 x 760) x 1	(1,240 x 1,690 x 760) x 2 + (930 x 1,690 x 760) x 1	
Dimensions (W x H x D) - Shipping	mm x No.	(1,280 x 1,825 x 796) x 2 + (960 x 1,825 x 796) x 1	(1,280 x 1,825 x 796) x 2 + (960 x 1,825 x 796) x 1	(1,280 x 1,825 x 796) x 2 + (960 x 1,825 x 796) x 1	(1,280 x 1,825 x 796) x 2 + (960 x 1,825 x 796) x 1	
Net Weight	kg x No.	(310 x 1) + (237 x 1) + (215 x 1)	(310 x 1) + (237 x 1) + (215 x 1)	(310 x 1) + (300 x 1) + (215 x 1)	(310 x 1) + (300 x 1) + (215 x 1)	
Shipping Weight	kg x No.	(320 x 1) + (250 x 1) + (225 x 1)	(320 x 1) + (250 x 1) + (225 x 1)	(320 x 1) + (312 x 1) + (225 x 1)	(320 x 1) + (312 x 1) + (225 x 1)	
Sound Pressure Level	Cooling	dB(A)	67	67.1	67.2	67.4
	Heating	dB(A)	68.6	68.7	68.8	69.5
Sound Power Level	Cooling	dB(A)	96.4	96.6	97.1	97.4
	Heating	dB(A)	100.3	100.5	100.8	101
Communication Cable	mm² x No. (VCTF-SB)		1.0 - 1.5 x 2C	1.0 - 1.5 x 2C	1.0 - 1.5 x 2C	
Refrigerant	Refrigerant Name		R410A	R410A	R410A	
	Precharged Amount in Factory	kg	40	40	42.5	42.5
	t-CO ₂ eq		83.5	83.5	88.7	88.7
	Control		Electronic Expansion Valve	Electronic Expansion Valve	Electronic Expansion Valve	Electronic Expansion Valve
Power Supply	Ø, V, Hz		3, 380-415, 50	3, 380-415, 50	3, 380-415, 50	
Number of Maximum Connectable Indoor Units ¹⁾		64	64	64	64	

1) Maximum numbers are prepared based on assumption that all 2.2kW indoor units are connected. The numbers in parentheses means maximum connectable indoor units in accordance with outdoor units combination (160% - 200%). The recommended ratio is 130%.

MULTI V 5

ARUM580LTE5 / ARUM600LTE5
ARUM620LTE5 / ARUM640LTE5
ARUM660LTE5



HP		58	60	62	64	66	
Model Name	Combination Unit	ARUM580LTE5	ARUM600LTE5	ARUM620LTE5	ARUM640LTE5	ARUM660LTE5	
	Independent Unit	ARUM240LTE5 ARUM220LTE5 ARUM120LTE5	ARUM240LTE5 ARUM240LTE5 ARUM120LTE5	ARUM240LTE5 ARUM240LTE5 ARUM140LTE5	ARUM240LTE5 ARUM240LTE5 ARUM160LTE5	ARUM240LTE5 ARUM240LTE5 ARUM180LTE5	
Capacity	Cooling (Rated) kW	162.4	168.0	173.6	179.2	184.8	
	Heating (Rated) kW	162.4	168.0	173.6	179.2	184.8	
	Heating (Max) kW	181.4	186.3	192.6	198.9	205.2	
Input	Cooling (Rated) kW	40.68	42.38	43.48	45.69	45.71	
	Heating (Rated) kW	36.89	38.63	39.91	42.06	41.90	
	Heating (Max) kW	43.82	45.86	47.32	49.99	49.54	
EER		3.99	3.96	3.99	3.92	4.04	
SEER		-	-	-	-	-	
COP	Rated Capacity	4.40	4.35	4.35	4.26	4.41	
	Max Capacity	4.14	4.06	4.07	3.98	4.14	
SCOP		-	-	-	-	-	
Exterior	Color	Warm Gray / Dawn Gray	Warm Gray / Dawn Gray	Warm Gray / Dawn Gray	Warm Gray / Dawn Gray	Warm Gray / Dawn Gray	
	RAL Code (Classic)	RAL 7044 / RAL 7037	RAL 7044 / RAL 7037	RAL 7044 / RAL 7037	RAL 7044 / RAL 7037	RAL 7044 / RAL 7037	
Heat Exchanger	Type	Wide Louver Plus / Black Fin	Wide Louver Plus / Black Fin	Wide Louver Plus / Black Fin	Wide Louver Plus / Black Fin	Wide Louver Plus / Black Fin	
	Type	Hermetically Sealed Scroll	Hermetically Sealed Scroll	Hermetically Sealed Scroll	Hermetically Sealed Scroll	Hermetically Sealed Scroll	
Compressor	Combination x No.	(Inverter) x 5	(Inverter) x 5	(Inverter) x 5	(Inverter) x 5	(Inverter) x 6	
	Motor Output x Number	W x No.	(5,300 x 4) + (4,200 x 1)	5,300 x 5	5,300 x 5	5,300 x 5	(5,300 x 5) + (4,200 x 1)
	Oil Type		FVC68D (PVE)	FVC68D (PVE)	FVC68D (PVE)	FVC68D (PVE)	FVC68D (PVE)
	Oil Charge	cc	14,300	14,300	14,300	14,300	15,600
	Type		Propeller fan	Propeller fan	Propeller fan	Propeller fan	Propeller fan
Fan	Motor Output x Number	W x No.	(900 x 4) + (1,200 x 1)	(900 x 4) + (1,200 x 1)	900 x 6	900 x 6	900 x 6
	Air Flow Rate (High)	m³/min x No.	(320 x 2) + (240 x 1)	(320 x 2) + (240 x 1)	320 x 3	320 x 3	320 x 3
	Drive		DC INVERTER	DC INVERTER	DC INVERTER	DC INVERTER	DC INVERTER
	Discharge	Side / Top	TOP	TOP	TOP	TOP	TOP
Pipe Connections for Heat Recovery	Liquid Pipe	mm (inch)	Ø19.05 (3/4)	Ø19.05 (3/4)	Ø22.2 (7/8)	Ø22.2 (7/8)	Ø22.2 (7/8)
	Low Pressure Gas Pipe	mm (inch)	Ø41.3 (1-5/8)	Ø41.3 (1-5/8)	Ø44.5 (1-3/4)	Ø44.5 (1-3/4)	Ø53.98 (2-1/8)
	High Pressure Gas Pipe	mm (inch)	Ø34.9 (1-3/8)	Ø34.9 (1-3/8)	Ø41.3 (1-5/8)	Ø41.3 (1-5/8)	Ø44.5 (1-3/4)
Pipe Connections for Heat Pump	Liquid Pipe	mm (inch)	Ø19.05 (3/4)	Ø19.05 (3/4)	Ø22.2 (7/8)	Ø22.2 (7/8)	Ø22.2 (7/8)
	Gas Pipe	mm (inch)	Ø41.3 (1-5/8)	Ø41.3 (1-5/8)	Ø44.5 (1-3/4)	Ø44.5 (1-3/4)	Ø53.98 (2-1/8)
Dimensions (W x H x D)	mm x No.	(1,240 x 1,690 x 760) x 2 + (930 x 1,690 x 760) x 1	(1,240 x 1,690 x 760) x 2 + (930 x 1,690 x 760) x 1	(1,240 x 1,690 x 760) x 3	(1,240 x 1,690 x 760) x 3	(1,240 x 1,690 x 760) x 3	
Dimensions (W x H x D) - Shipping	mm x No.	(1,280 x 1,825 x 796) x 2 + (960 x 1,825 x 796) x 1	(1,280 x 1,825 x 796) x 2 + (960 x 1,825 x 796) x 1	(1,280 x 1,825 x 796) x 3	(1,280 x 1,825 x 796) x 3	(1,280 x 1,825 x 796) x 3	
Net Weight	kg x No.	(310 x 1) + (300 x 1) + (215 x 1)	(310 x 1) + (300 x 1) + (215 x 1)	(310 x 2) + (215 x 1)	(310 x 2) + (237 x 1)	(310 x 2) + (300 x 1)	
Shipping Weight	kg x No.	(320 x 1) + (312 x 1) + (225 x 1)	(320 x 1) + (312 x 1) + (225 x 1)	(320 x 2) + (225 x 1)	(320 x 2) + (250 x 1)	(320 x 2) + (312 x 1)	
Sound Pressure Level	Cooling	dB(A)	68.3	68.5	68.6	68.7	68.8
	Heating	dB(A)	69.8	70.4	70.5	70.6	70.6
Sound Power Level	Cooling	dB(A)	97.4	98.3	98.5	98.6	99.0
	Heating	dB(A)	101.4	102.2	102.5	102.6	102.8
Communication Cable	mm² x No. (VCTF-SB)		1.0 - 1.5 x 2C	1.0 - 1.5 x 2C	1.0 - 1.5 x 2C	1.0 - 1.5 x 2C	
Refrigerant	Refrigerant Name		R410A	R410A	R410A	R410A	
	Precharged Amount in Factory	kg	42.5	43.5	47.5	47.5	50.0
	t-CO ₂ eq		88.7	90.8	99.2	99.2	104.4
	Control		Electronic Expansion Valve	Electronic Expansion Valve	Electronic Expansion Valve	Electronic Expansion Valve	Electronic Expansion Valve
Power Supply	Ø, V, Hz		3, 380-415, 50	3, 380-415, 50	3, 380-415, 50	3, 380-415, 50	
Number of Maximum Connectable Indoor Units ¹⁾		64	64	64	64	64	

1) Maximum numbers are prepared based on assumption that all 2.2kW indoor units are connected. The numbers in parentheses means maximum connectable indoor units in accordance with outdoor units combination (160% - 200%). The recommended ratio is 130%.

MULTI V 5

ARUM680LTE5 / ARUM700LTE5
ARUM720LTE5 / ARUM740LTE5
ARUM760LTE5



HP		68	70	72	74	76	
Model Name	Combination Unit	ARUM680LTE5	ARUM700LTE5	ARUM720LTE5	ARUM740LTE5	ARUM760LTE5	
	Independent Unit	ARUM240LTE5 ARUM240LTE5 ARUM200LTE5	ARUM240LTE5 ARUM240LTE5 ARUM220LTE5	ARUM240LTE5 ARUM240LTE5 ARUM240LTE5	ARUM240LTE5 ARUM240LTE5 ARUM140LTE5 ARUM120LTE5	ARUM240LTE5 ARUM240LTE5 ARUM160LTE5 ARUM120LTE5	
Capacity	Cooling (Rated)	kW	190.4	196.0	201.6	207.2	212.8
	Heating (Rated)	kW	190.4	196.0	201.6	207.2	212.8
	Heating (Max)	kW	211.5	217.8	222.8	230.4	236.7
Input	Cooling (Rated)	kW	47.57	50.50	52.20	51.06	53.27
	Heating (Rated)	kW	43.98	45.93	47.67	46.76	48.91
	Heating (Max)	kW	52.28	54.36	56.40	55.58	58.25
EER		4.00	3.88	3.86	4.06	3.99	
SEER		-	-	-	-	-	
COP	Rated Capacity		4.33	4.27	4.23	4.43	4.35
	Max Capacity		4.05	4.01	3.95	4.15	4.06
SCOP		-	-	-	-	-	
Exterior	Color	Warm Gray / Dawn Gray	Warm Gray / Dawn Gray	Warm Gray / Dawn Gray	Warm Gray / Dawn Gray	Warm Gray / Dawn Gray	
	RAL Code (Classic)	RAL 7044 / RAL 7037	RAL 7044 / RAL 7037	RAL 7044 / RAL 7037	RAL 7044 / RAL 7037	RAL 7044 / RAL 7037	
Heat Exchanger	Type	Wide Louver Plus / Black Fin	Wide Louver Plus / Black Fin	Wide Louver Plus / Black Fin	Wide Louver Plus / Black Fin	Wide Louver Plus / Black Fin	
	Type	Hermetically Sealed Scroll	Hermetically Sealed Scroll	Hermetically Sealed Scroll	Hermetically Sealed Scroll	Hermetically Sealed Scroll	
Compressor	Combination x No.	(Inverter) x 6	(Inverter) x 6	(Inverter) x 6	(Inverter) x 6	(Inverter) x 6	
	Motor Output x Number	W x No.	(5,300 x 5) + (4,200 x 1)	(5,300 x 5) + (4,200 x 1)	5,300 x 6	5,300 x 6	5,300 x 6
	Oil Type		FVC68D (PVE)	FVC68D (PVE)	FVC68D (PVE)	FVC68D (PVE)	FVC68D (PVE)
	Oil Charge	cc	15,600	15,600	15,600	18,200	18,200
Fan	Type		Propeller fan	Propeller fan	Propeller fan	Propeller fan	
	Motor Output x Number	W x No.	900 x 6	900 x 6	900 x 6	(900 x 6) + (1,200 x 1)	(900 x 6) + (1,200 x 1)
	Air Flow Rate (High)	m³/min x No.	320 x 3	320 x 3	320 x 3	(320 x 3) + (240 x 1)	(320 x 3) + (240 x 1)
	Drive		DC INVERTER	DC INVERTER	DC INVERTER	DC INVERTER	DC INVERTER
	Discharge	Side / Top	TOP	TOP	TOP	TOP	TOP
Pipe Connections for Heat Recovery	Liquid Pipe	mm (inch)	Ø22.2 (7/8)	Ø22.2 (7/8)	Ø22.2 (7/8)	Ø22.2 (7/8)	Ø22.2 (7/8)
	Low Pressure Gas Pipe	mm (inch)	Ø53.98 (2-1/8)	Ø53.98 (2-1/8)	Ø53.98 (2-1/8)	Ø53.98 (2-1/8)	Ø53.98 (2-1/8)
	High Pressure Gas Pipe	mm (inch)	Ø44.5 (1-3/4)	Ø44.5 (1-3/4)	Ø44.5 (1-3/4)	Ø44.5 (1-3/4)	Ø44.5 (1-3/4)
Pipe Connections for Heat Pump	Liquid Pipe	mm (inch)	Ø22.2 (7/8)	Ø22.2 (7/8)	Ø22.2 (7/8)	Ø22.2 (7/8)	Ø22.2 (7/8)
	Gas Pipe	mm (inch)	Ø53.98 (2-1/8)	Ø53.98 (2-1/8)	Ø53.98 (2-1/8)	Ø53.98 (2-1/8)	Ø53.98 (2-1/8)
Dimensions (W x H x D)	mm x No.	(1,240 x 1,690 x 760) x 3	(1,240 x 1,690 x 760) x 3	(1,240 x 1,690 x 760) x 3	(1,240 x 1,690 x 760) x 3 + (930 x 1,690 x 760) x 1	(1,240 x 1,690 x 760) x 3 + (930 x 1,690 x 760) x 1	
Dimensions (W x H x D) - Shipping	mm x No.	(1,280 x 1,825 x 796) x 3	(1,280 x 1,825 x 796) x 3	(1,280 x 1,825 x 796) x 3	(1,280 x 1,825 x 796) x 3 + (960 x 1,825 x 796) x 1	(1,280 x 1,825 x 796) x 3 + (960 x 1,825 x 796) x 1	
Net Weight	kg x No.	(310 x 2) + (300 x 1)	(310 x 2) + (300 x 1)	310 x 3	(310 x 2) + (237 x 1) + (215 x 1)	(310 x 2) + (237 x 1) + (215 x 1)	
Shipping Weight	kg x No.	(320 x 2) + (312 x 1)	(320 x 2) + (312 x 1)	320 x 3	(320 x 2) + (250 x 1) + (225 x 1)	(320 x 2) + (250 x 1) + (225 x 1)	
Sound Pressure Level	Cooling	dB(A)	69.0	69.6	69.8	69.1	69.2
	Heating	dB(A)	71.1	71.3	71.8	70.9	70.9
Sound Power Level	Cooling	dB(A)	99.2	99.2	99.8	98.8	98.9
	Heating	dB(A)	103.0	103.2	103.8	102.7	102.8
Communication Cable	mm² x No. (VCTF-SB)	1.0 - 1.5 x 2C	1.0 - 1.5 x 2C	1.0 - 1.5 x 2C	1.0 - 1.5 x 2C	1.0 - 1.5 x 2C	
Refrigerant	Refrigerant Name		R410A	R410A	R410A	R410A	
	Precharged Amount in Factory	kg	50.0	50.0	51.0	57.0	57.0
	t-CO ₂ eq		104.4	104.4	106.5	119.0	119.0
	Control		Electronic Expansion Valve	Electronic Expansion Valve	Electronic Expansion Valve	Electronic Expansion Valve	Electronic Expansion Valve
Power Supply	Ø, V, Hz	3, 380-415, 50	3, 380-415, 50	3, 380-415, 50	3, 380-415, 50	3, 380-415, 50	
Number of Maximum Connectable Indoor Units ¹⁾		64	64	64	64	64	

1) Maximum numbers are prepared based on assumption that all 2.2kW indoor units are connected. The numbers in parentheses means maximum connectable indoor units in accordance with outdoor units combination (160% - 200%). The recommended ratio is 130%.

MULTI V 5

ARUM780LTE5 / ARUM800LTE5
ARUM820LTE5 / ARUM840LTE5
ARUM860LTE5



HP		78	80	82	84	86	
Model Name	Combination Unit	ARUM780LTE5	ARUM800LTE5	ARUM820LTE5	ARUM840LTE5	ARUM860LTE5	
	Independent Unit	ARUM240LTE5 ARUM240LTE5 ARUM180LTE5 ARUM120LTE5	ARUM240LTE5 ARUM240LTE5 ARUM200LTE5 ARUM120LTE5	ARUM240LTE5 ARUM240LTE5 ARUM220LTE5 ARUM120LTE5	ARUM240LTE5 ARUM240LTE5 ARUM240LTE5 ARUM240LTE5 ARUM120LTE5	ARUM240LTE5 ARUM240LTE5 ARUM240LTE5 ARUM240LTE5 ARUM120LTE5	
Capacity	Cooling (Rated)	kW	218.4	224.0	229.6	235.2	240.8
	Heating (Rated)	kW	218.4	224.0	229.6	235.2	240.8
	Heating (Max)	kW	243.0	249.3	255.6	260.6	266.9
Input	Cooling (Rated)	kW	53.29	55.15	58.08	59.78	60.88
	Heating (Rated)	kW	48.75	50.83	52.78	54.52	55.80
	Heating (Max)	kW	57.80	60.54	62.62	64.66	66.12
EER		4.10	4.06	3.95	3.93	3.96	
SEER		-	-	-	-	-	
COP	Rated Capacity		4.48	4.41	4.35	4.31	4.32
	Max Capacity		4.20	4.12	4.08	4.03	4.04
SCOP		-	-	-	-	-	
Exterior	Color	Warm Gray / Dawn Gray	Warm Gray / Dawn Gray	Warm Gray / Dawn Gray	Warm Gray / Dawn Gray	Warm Gray / Dawn Gray	
	RAL Code (Classic)	RAL 7044 / RAL 7037	RAL 7044 / RAL 7037	RAL 7044 / RAL 7037	RAL 7044 / RAL 7037	RAL 7044 / RAL 7037	
Heat Exchanger	Type	Wide Louver Plus / Black Fin	Wide Louver Plus / Black Fin	Wide Louver Plus / Black Fin	Wide Louver Plus / Black Fin	Wide Louver Plus / Black Fin	
	Type	Hermetically Sealed Scroll	Hermetically Sealed Scroll	Hermetically Sealed Scroll	Hermetically Sealed Scroll	Hermetically Sealed Scroll	
Compressor	Combination x No.	(Inverter) x 7	(Inverter) x 7	(Inverter) x 7	(Inverter) x 7	(Inverter) x 7	
	Motor Output x Number	W x No.	(5,300 x 6) + (4,200 x 1)	(5,300 x 6) + (4,200 x 1)	(5,300 x 6) + (4,200 x 1)	5,300 x 7	5,300 x 7
	Oil Type		FVC68D (PVE)	FVC68D (PVE)	FVC68D (PVE)	FVC68D (PVE)	FVC68D (PVE)
	Oil Charge	cc	19,500	19,500	19,500	19,500	19,500
Fan	Type		Propeller fan	Propeller fan	Propeller fan	Propeller fan	
	Motor Output x Number	W x No.	(900 x 6) + (1,200 x 1)	(900 x 6) + (1,200 x 1)	(900 x 6) + (1,200 x 1)	(900 x 6) + (1,200 x 1)	900 x 8
	Air Flow Rate (High)	m³/min x No.	(320 x 3) + (240 x 1)	(320 x 3) + (240 x 1)	(320 x 3) + (240 x 1)	(320 x 3) + (240 x 1)	320 x 4
	Drive		DC INVERTER	DC INVERTER	DC INVERTER	DC INVERTER	DC INVERTER
	Discharge	Side / Top	TOP	TOP	TOP	TOP	TOP
Pipe Connections for Heat Recovery	Liquid Pipe	mm (inch)	Ø22.2 (7/8)	Ø22.2 (7/8)	Ø22.2 (7/8)	Ø22.2 (7/8)	Ø22.2 (7/8)
	Low Pressure Gas Pipe	mm (inch)	Ø53.98 (2-1/8)	Ø53.98 (2-1/8)	Ø53.98 (2-1/8)	Ø53.98 (2-1/8)	Ø53.98 (2-1/8)
	High Pressure Gas Pipe	mm (inch)	Ø44.5 (1-3/4)	Ø44.5 (1-3/4)	Ø44.5 (1-3/4)	Ø44.5 (1-3/4)	Ø44.5 (1-3/4)
Pipe Connections for Heat Pump	Liquid Pipe	mm (inch)	Ø22.2 (7/8)	Ø22.2 (7/8)	Ø22.2 (7/8)	Ø22.2 (7/8)	Ø22.2 (7/8)
	Gas Pipe	mm (inch)	Ø53.98 (2-1/8)	Ø53.98 (2-1/8)	Ø53.98 (2-1/8)	Ø53.98 (2-1/8)	Ø53.98 (2-1/8)
Dimensions (W x H x D)	mm x No.	(1,240 x 1,690 x 760) x 3 + (930 x 1,690 x 760) x 1	(1,240 x 1,690 x 760) x 3 + (930 x 1,690 x 760) x 1	(1,240 x 1,690 x 760) x 3 + (930 x 1,690 x 760) x 1	(1,240 x 1,690 x 760) x 3 + (930 x 1,690 x 760) x 1	(1,240 x 1,690 x 760) x 4	
Dimensions (W x H x D) - Shipping	mm x No.	(1,280 x 1,825 x 796) x 3 + (960 x 1,825 x 796) x 1	(1,280 x 1,825 x 796) x 3 + (960 x 1,825 x 796) x 1	(1,280 x 1,825 x 796) x 3 + (960 x 1,825 x 796) x 1	(1,280 x 1,825 x 796) x 3 + (960 x 1,825 x 796) x 1	(1,280 x 1,825 x 796) x 4	
Net Weight	kg x No.	(310 x 2) + (300 x 1) + (215 x 1)	(310 x 2) + (300 x 1) + (215 x 1)	(310 x 2) + (300 x 1) + (215 x 1)	(310 x 2) + (300 x 1) + (215 x 1)	(310 x 3) + (215 x 1)	
Shipping Weight	kg x No.	(320 x 2) + (312 x 1) + (225 x 1)	(320 x 2) + (312 x 1) + (225 x 1)	(320 x 2) + (312 x 1) + (225 x 1)	(320 x 2) + (312 x 1) + (225 x 1)	(320 x 3) + (250 x 1)	
Sound Pressure Level	Cooling	dB(A)	69.2	69.4	70.0	70.1	70.2
	Heating	dB(A)	71.0	71.4	71.6	72.1	72.1
Sound Power Level	Cooling	dB(A)	99.2	99.4	99.4	99.9	100.1
	Heating	dB(A)	103.0	103.2	103.4	103.9	104.1
Communication Cable	mm² x No. (VCTF-SB)	1.0 - 1.5 x 2C	1.0 - 1.5 x 2C	1.0 - 1.5 x 2C	1.0 - 1.5 x 2C	1.0 - 1.5 x 2C	
Refrigerant	Refrigerant Name		R410A	R410A	R410A	R410A	
	Precharged Amount in Factory	kg	59.5	59.5	59.5	60.5	64.5
	t-CO ₂ eq		124.2	124.2	124.2	126.3	134.6
	Control		Electronic Expansion Valve	Electronic Expansion Valve	Electronic Expansion Valve	Electronic Expansion Valve	Electronic Expansion Valve
Power Supply	Ø, V, Hz	3, 380-415, 50	3, 380-415, 50	3, 380-415, 50	3, 380-415, 50	3, 380-415, 50	
Number of Maximum Connectable Indoor Units ¹⁾		64	64	64	64	64	

1) Maximum numbers are prepared based on assumption that all 2.2kW indoor units are connected. The numbers in parentheses means maximum connectable indoor units in accordance with outdoor units combination (160% - 200%). The recommended ratio is 130%.

MULTI V 5

ARUM880LTE5 / ARUM900LTE5
 ARUM920LTE5 / ARUM940LTE5
 ARUM960LTE5



HP		88	90	92	94	96
Model Name	Combination Unit	ARUM880LTE5 ARUM240LTE5	ARUM900LTE5 ARUM240LTE5	ARUM920LTE5 ARUM240LTE5	ARUM940LTE5 ARUM240LTE5	ARUM960LTE5 ARUM240LTE5
	Independent Unit	ARUM240LTE5 ARUM240LTE5 ARUM160LTE5	ARUM240LTE5 ARUM240LTE5 ARUM180LTE5	ARUM240LTE5 ARUM240LTE5 ARUM200LTE5	ARUM240LTE5 ARUM240LTE5 ARUM220LTE5	ARUM240LTE5 ARUM240LTE5 ARUM240LTE5
Capacity	Cooling (Rated)	kW 246.4	252.0	257.6	263.2	268.8
	Heating (Rated)	kW 246.4	252.0	257.6	263.2	268.8
	Heating (Max)	kW 273.2	279.5	285.8	292.1	297.0
Input	Cooling (Rated)	kW 63.09	63.11	64.97	67.90	69.60
	Heating (Rated)	kW 57.95	57.79	59.87	61.82	63.56
	Heating (Max)	kW 68.79	68.34	71.08	73.16	75.19
EER		3.91	3.99	3.96	3.88	3.86
SEER		-	-	-	-	-
COP	Rated Capacity	4.25	4.36	4.30	4.26	4.23
	Max Capacity	3.97	4.09	4.02	3.99	3.95
SCOP		-	-	-	-	-
Exterior	Color	Warm Gray / Dawn Gray	Warm Gray / Dawn Gray	Warm Gray / Dawn Gray	Warm Gray / Dawn Gray	Warm Gray / Dawn Gray
	RAL Code (Classic)	RAL 7044 / RAL 7037	RAL 7044 / RAL 7037	RAL 7044 / RAL 7037	RAL 7044 / RAL 7037	RAL 7044 / RAL 7037
Heat Exchanger	Type	Wide Louver Plus / Black Fin	Wide Louver Plus / Black Fin	Wide Louver Plus / Black Fin	Wide Louver Plus / Black Fin	Wide Louver Plus / Black Fin
	Type	Hermetically Sealed Scroll	Hermetically Sealed Scroll	Hermetically Sealed Scroll	Hermetically Sealed Scroll	Hermetically Sealed Scroll
Compressor	Type	(Inverter) x 7	(Inverter) x 8	(Inverter) x 8	(Inverter) x 8	(Inverter) x 8
	Motor Output x Number	W x No. 5,300 x 7	(5,300 x 7) + (4,200 x 1)	(5,300 x 7) + (4,200 x 1)	(5,300 x 7) + (4,200 x 1)	5,300 x 8
	Oil Type	FVC68D (PVE)	FVC68D (PVE)	FVC68D (PVE)	FVC68D (PVE)	FVC68D (PVE)
	Oil Charge	cc 19,500	20,800	20,800	20,800	20,800
Fan	Type	Propeller fan	Propeller fan	Propeller fan	Propeller fan	Propeller fan
	Motor Output x Number	W x No. 900 x 8	900 x 8	900 x 8	900 x 8	900 x 8
	Air Flow Rate (High)	m³/min x No. 320 x 4	320 x 4	320 x 4	320 x 4	320 x 4
	Drive	DC INVERTER	DC INVERTER	DC INVERTER	DC INVERTER	DC INVERTER
Pipe Connections for Heat Recovery	Liquid Pipe	mm (inch) Ø22.2 (7/8)	Ø22.2 (7/8)	Ø22.2 (7/8)	Ø22.2 (7/8)	Ø22.2 (7/8)
	Low Pressure Gas Pipe	mm (inch) Ø53.98 (2-1/8)	Ø53.98 (2-1/8)	Ø53.98 (2-1/8)	Ø53.98 (2-1/8)	Ø53.98 (2-1/8)
Pipe Connections for Heat Pump	Liquid Pipe	mm (inch) Ø22.2 (7/8)	Ø22.2 (7/8)	Ø22.2 (7/8)	Ø22.2 (7/8)	Ø22.2 (7/8)
	Gas Pipe	mm (inch) Ø53.98 (2-1/8)	Ø53.98 (2-1/8)	Ø53.98 (2-1/8)	Ø53.98 (2-1/8)	Ø53.98 (2-1/8)
Dimensions (W x H x D)	mm x No.	(1,240 x 1,690 x 760) x 4	(1,240 x 1,690 x 760) x 4	(1,240 x 1,690 x 760) x 4	(1,240 x 1,690 x 760) x 4	(1,240 x 1,690 x 760) x 4
Dimensions (W x H x D) - Shipping	mm x No.	(1,280 x 1,825 x 796) x 4	(1,280 x 1,825 x 796) x 4	(1,280 x 1,825 x 796) x 4	(1,280 x 1,825 x 796) x 4	(1,280 x 1,825 x 796) x 4
Net Weight	kg x No.	(310 x 3) + (237 x 1)	(310 x 3) + (300 x 1)	(310 x 3) + (300 x 1)	(310 x 3) + (300 x 1)	310 x 4
Shipping Weight	kg x No.	(320 x 3) + (250 x 1)	(320 x 3) + (312 x 1)	(320 x 3) + (312 x 1)	(320 x 3) + (312 x 1)	320 x 4
Sound Pressure Level	Cooling	dB(A) 70.3	70.3	70.4	70.9	71.0
	Heating	dB(A) 72.2	72.2	72.5	72.7	73.0
Sound Power Level	Cooling	dB(A) 100.2	100.4	100.6	100.6	101.0
	Heating	dB(A) 104.2	104.3	104.4	104.6	105.0
Communication Cable	mm² x No. (VCTF-SB)	1.0 - 1.5 x 2C	1.0 - 1.5 x 2C	1.0 - 1.5 x 2C	1.0 - 1.5 x 2C	1.0 - 1.5 x 2C
Refrigerant	Refrigerant Name	R410A	R410A	R410A	R410A	R410A
	Precharged Amount in Factory	kg 64.5	67.0	67.0	67.0	68.0
	t-CO ₂ eq	134.6	139.9	139.9	139.9	142.0
	Control	Electronic Expansion Valve	Electronic Expansion Valve	Electronic Expansion Valve	Electronic Expansion Valve	Electronic Expansion Valve
Power Supply	Ø, V, Hz	3, 380-415, 50	3, 380-415, 50	3, 380-415, 50	3, 380-415, 50	3, 380-415, 50
Number of Maximum Connectable Indoor Units ¹⁾		64	64	64	64	64

1) Maximum numbers are prepared based on assumption that all 2.2kW indoor units are connected. The numbers in parentheses means maximum connectable indoor units in accordance with outdoor units combination (160% - 200%). The recommended ratio is 130%.

NOTE

1. Eurovent Test Condition : For more info regarding program consult www.eurovent-certification.com

2. Capacities are based on the following conditions :

- Cooling Temperature : Indoor 27°C (80.6°F) DB / 19°C (66.2°F) WB Outdoor 35°C (95°F) DB / 24°C (75.2°F) WB
- Heating Temperature : Indoor 20°C (68°F) DB / 15°C (59°F) WB Outdoor 7°C (44.6°F) DB / 6°C (42.8°F) WB
- Piping Length : Interconnected Pipe Length = 7.5m
- Difference Limit of Elevation (Outdoor - Indoor Unit) is 0m.

3. Wiring cable size must comply with the applicable local and national code.

4. Sound pressure level is measured on the rated condition in the anechoic rooms by ISO 3745 standard. Sound power level is measured on the rated condition in the reverberation rooms by ISO 3741 standard. Therefore, these values can be increased owing to ambient conditions during operation.

5. Explanation of Terms

- EER : Energy Efficiency Ratio (Cooling)
- SEER : Seasonal Energy Efficiency Ratio (Refer to Typical Cooling Season)
- COP : Coefficient Of Performance (Heating)
- SCOP : Seasonal Coefficient Of Performance (Refer to Typical Heating Season)

6. Due to our policy of innovation some specifications may be changed without notification.

7. This product contains Fluorinated greenhouse gases.

MULTI VTM S

- Air cooled VRF Heat pump & Heat Recovery
- 12.1 ~ 33.6kW (Cooling capacity based)
- Both 1Ø, 220 ~ 240V, 50Hz and 3Ø, 380 ~ 415V, 50Hz
- Side discharge outdoor unit
- Includes the industry's first single phase Heat Recovery system

300M
TOTAL PIPING LENGTH

Compact yet powerful VRF
For premium residences and small offices

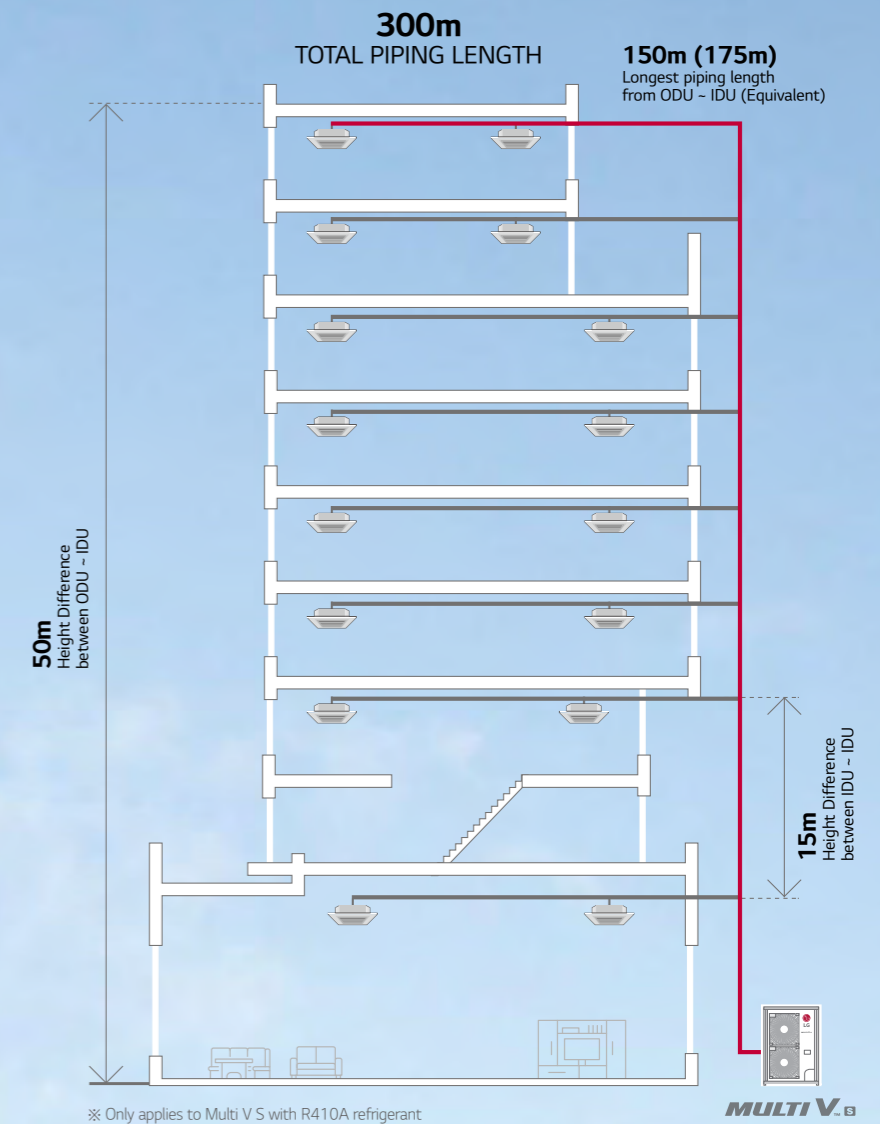

Energy savings



Reliability



Convenience

How does it work?

Available in Heat Pump and Heat Recovery Configurations

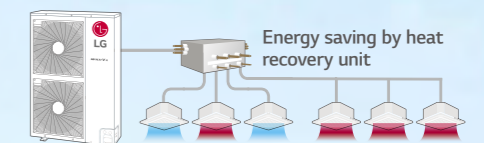

Combination of Cooling, Heating and Hot Water Solution

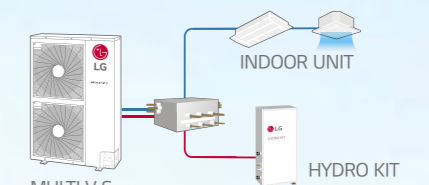

※ Heat Pump and Recovery are separated models.

ENERGY SAVINGS

EER / COP / Part Load

Cost savings with energy efficiency

Heat Pump

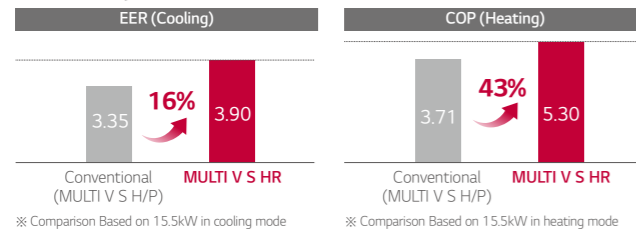

Heat Recovery

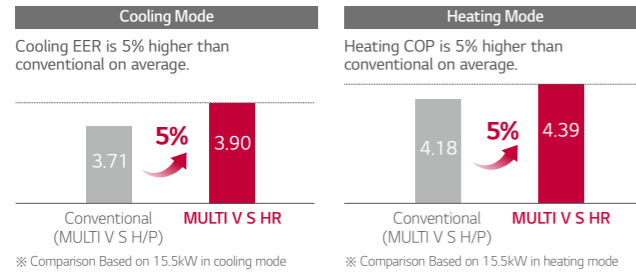

Smart Load Control Applied

Enhanced comfort and up to 23% energy savings with MULTI V load control

MULTI V S changes indoor discharge air temperature continuously according to load, to save energy.

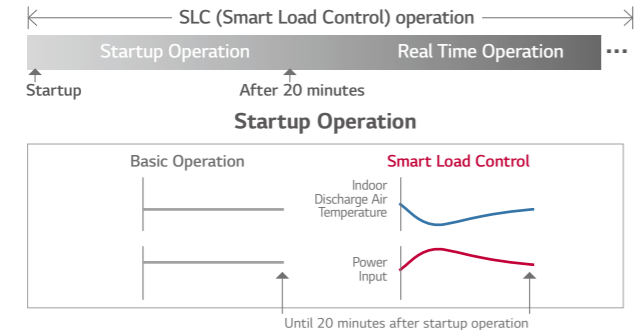

※ Indoor air discharge temperature

- Energy efficiency increased by 3-step Smart Load Control during startup phase
- Discharge air temperature adjusted according to outdoor and indoor temperature
- Comfort level in cooling / heating operations ensured

Max 10% Energy saving

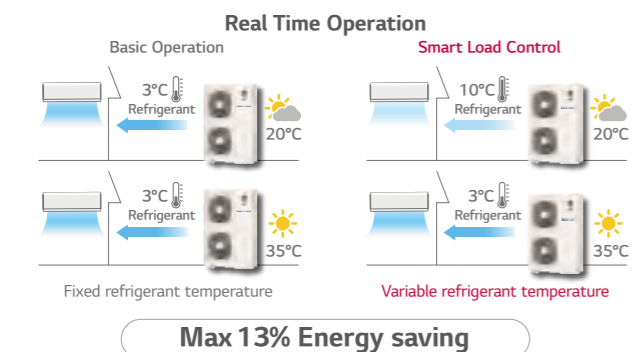

※ How to set up : By dip switch in outdoor unit (Referred to Product Data Book) Factory default setting is Off.

※ ESEER (European seasonal energy efficiency Ratio) conditions based on 15.5kw unit

- Outdoor temperature condition : EER 100% / 75% / 50% / 25% = 35°C (DB) / 30°C (DB) / 25°C (DB) / 20°C (DB)
- Indoor temperature condition : 27°C (DB) / 19°C (WB)

※ Dual sensing (Temperature & humidity) smart load control is possible with Remote controller PTEMTB100 (White) /PREMTBB10 (Black)

Inverter Twin Rotary & Inverter Scroll Compressor

Adapted High Efficient Compressor according to Capacity

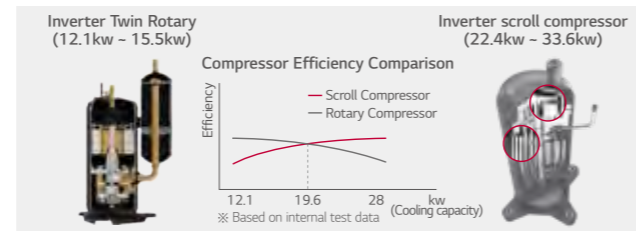

Inverter Twin Rotary Concentrated Winding Motor

Oil path area is improved by over 50% by increasing the extra stator cavity. Due to this, caloric value of motor is reduced, improving the cooling function of stator coil.

Twin Rotary Rotor

Upper and lower part rotor offset imbalance in shaft rotor rotation. Vibration and noise is reduced. Max torque load decreased by 45% compared to single rotor.

Surface Coating

Surface coating of outstanding abrasion resistance property on vane and crank shaft.

Inverter scroll compressor

Best-in-class Compressor Speed

- Rapid response capability
- Compact core design (Concentrated motor)
- Down to 15Hz : Part load efficiency improvement

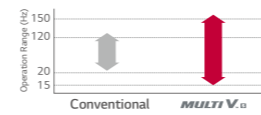

6 Bypass Valve

Compressor reliability is maximized with 6 Bypass Valve

- Prevent compressor damage due to excessively compressed refrigerant more efficiently than 4 Bypass valve

Direct Oil Injection

- Eliminate suction refrigerant gas heat loss through direct oil injection into compression chamber (Efficiency increases)
- Increased reliability with regulated oil supply

Scroll Profile

- The enhanced reliability by increased reliability with regulated oil supply.
- Efficiency increases by expanding 96% Bypass area and 17% improved volume ratio by non-uniform scroll thickness

Optimal Heat Exchanger

Maximize Efficiency according to different Heat Exchanger path by cooling and heating

Variable Heat Exchanger Circuit intelligently selects the optimal path for both heating and cooling operations. With this smart path selection technology, an average of 6% increase in the efficiency of both operations has been achieved. The paths number and circuit velocity are adjusted to match temperatures and operation modes in order to maximize efficiency instead of compromising efficiency for each operation when the number and direction of paths are fixed independently of temperature operation mode.

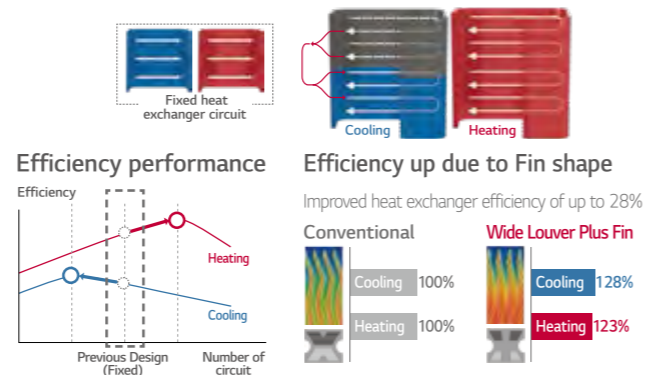

RELIABILITY

Reliable Refrigerant Components

LG technology allows for superior performance and component durability

- 1 Cyclonic oil separator**
 - Highly reliable and efficient oil separation by centrifuge using cyclonic methods
 - High collection efficiency as well as outstanding resistance to high temperature and pressure
- 2 Large Volume Accumulator**
 - Improved reliability by adopting the large volume accumulator (38% volume up compared to conventional)
 - Prevents the liquid refrigerant entering the compressor suction
 - Maximize efficiency by optimal amount of refrigerant
 - Protects compressor breakdown to increase product lifetime
- 3 BLDC Fan Motor**
 - The BLDC Fan motor is more efficient than a conventional AC motor, offering an additional 40% energy savings at low speeds and 20% at high speeds
- 4 Double Sub-cool Interchanger**
 - Reliability is enhanced by minimizing pressure drop due to high efficiency spiral structure and 2 times larger size
 - Long pipe is possible (up to* 175m) and high elevation (up to* 50m)
 - Reduction of indoor refrigerant noise level

MULTI V S improved reliability with advanced technology :

- Oil separator
- Accumulator
- Sub-cooling

* Based on equivalent pipe length

Smart Control

Pressure control applied for smart, quick and precise response to user's temperature request

Temperature + Pressure Control

Senses and controls pressure directly using pressure sensor for faster and more exact response to load variation.

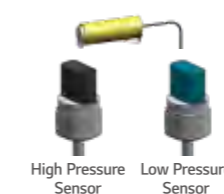

Quick Operating Response

Desired temperature can be reached up to 14% faster in cooling mode with pressure control, allowing more accurate control of indoor environment for maximized comfort.

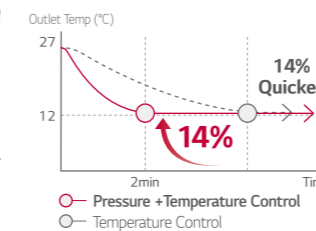

※ Specifications may vary for each model.

Corrosion Resistance Proven by Certified Tests

LG Corrosion Resistance solution passed ISO 21207 accelerated corrosion test conducted by an independent test organization and the result has been certified by prestigious global certification organization, TUV.

Certified protection



※ Verification of corrosion resistance performance

- Declared by TÜV Rheinland
- Test Method B of ISO 21207
- Test condition: Salt contaminated condition + severe industrial/traffic environment (NO2/SO2)

Enhanced Coating Layers

The black coating with enhanced epoxy resin is applied for strong protection from various corrosive external conditions such as salt contamination and air pollution. Moreover, the hydrophilic film keeps water from accumulating on the heat exchanger's fin, minimizing moisture buildup and eventually making it even more corrosion resistant.

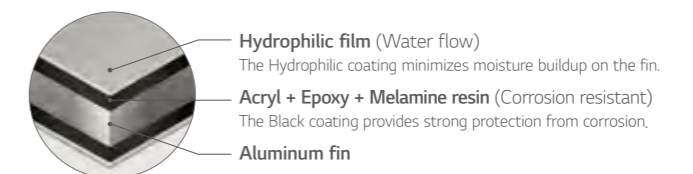

IMPROVED USER CONVENIENCE

Sufficient Piping Length

Increased piping length allows for flexible design and installation

MULTI V S inverter technology and sub cooling control circuit technology allows greater piping length and outstanding elevation differences. A cooling system can be implemented more flexibly in a shop, office and even high-rise building, reducing the designer's work time and providing more efficient design.

Piping Capabilities

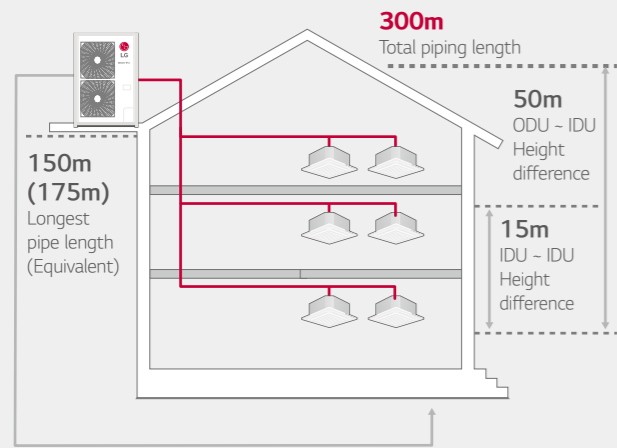

4 Way Piping

- Free design and installation by 4 way piping.

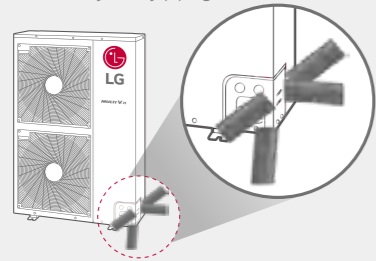

Low Noise Operation

Decreased noise during operation with low noise functionality

At night mode, noise reduced maximum 14% compared to normal mode.

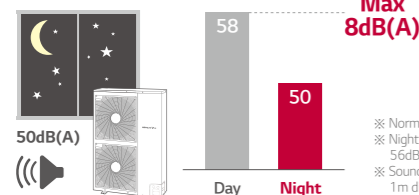
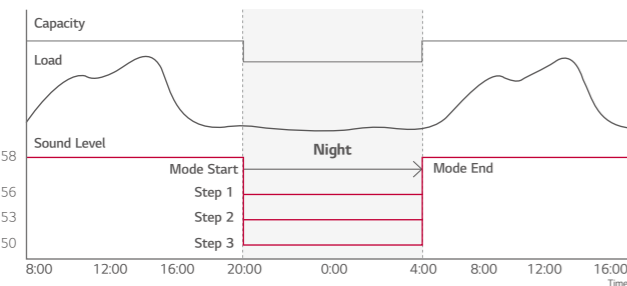

※ Normal mode noise level (28kw): 58dB(A)
 ※ Night 3 step noise level (28kw): 56dB(A), 53dB(A), 50dB(A)
 ※ Sound pressure tested by following conditions: 1m distance / 1.5m height

Fan Technology and RPM Control

External static pressure control for outdoor unit fan to adapt more flexibly to various installation conditions of outdoor unit

For enhanced efficiency, new axial fan boasts higher air volume, increased static pressure and decreased noise.

Fan Technology

The new axial fan has a mogul trailing edge, narrow hub blade and reverse hub, this provides a high efficiency, low noise, wide fan, as well as improving the air flow rate.

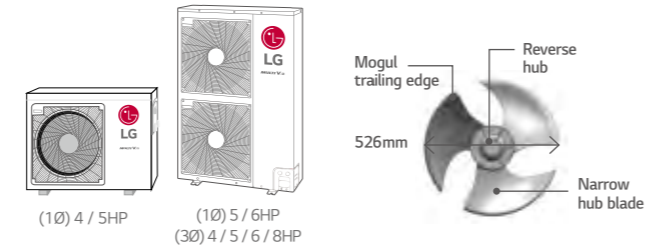

Super canon fan increases the air volume in 50 CMM and the noise level is decreased by 4dB(A).

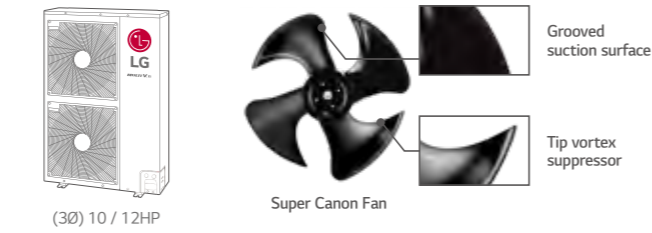

Fan RPM control

Flow of air is straight due to fan shroud and Fan RPM control even in high-rise building.

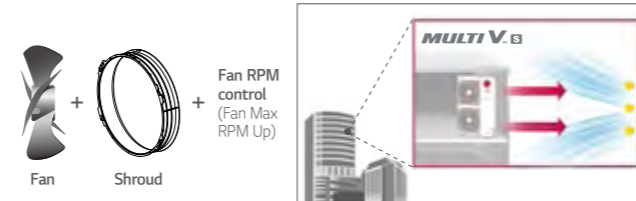

- Straight air flow
- New shroud adopted
- Performs high static pressure

Upgraded Fault Detection and Diagnosis

Easy and convenient maintenance with self-diagnosis

The inclusion of FDD elements - Auto start-up, auto refrigerant check, black box functionality, simultaneous evaluation, and auto refrigerant collection, provides the optimal solution for user reliability and ease of maintenance.

- Auto commissioning Mode
- Auto Refrigerant Collection
- Auto evaluation of refrigerant amount and charging
- Able to access LGMV (LG Monitoring View) by smartphone
- Black box function
- Piping & wiring error check-up

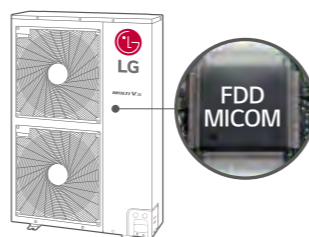

Nomenclature

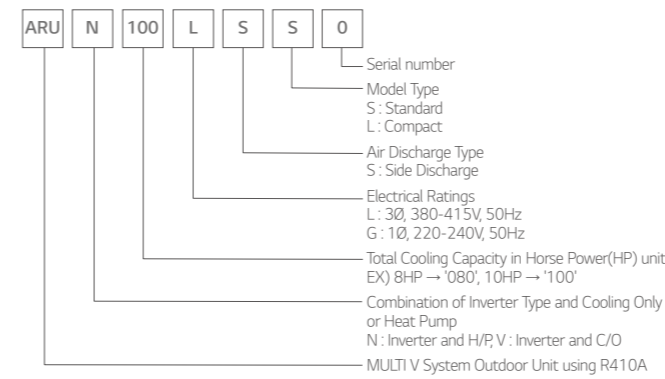

Outdoor Units Function

Category	Functions	MULTI V S
Key Refrigerant Components	Variable Path of Outdoor Unit HEX	-
	HiPOR™ (High Pressure Oil Return)	-
	Humidity Sensor	ARUB06GSS4 only
	Corrosion Resistance Black Fin	-
	Oil Sensor	-
Special Function	Dual Sensing	ARUB06GSS4 only
	Low Noise Operation	○
	High Static Mode of Outdoor Unit Fan	○
	Partial Defrosting	-
	Auto Dust Removal of Outdoor Unit (Fan reverse rotation)	-
Basic Function	Indoor Cooling Comfort Mode Based Outdoor Temperature	○
	Smart Load Control (SLC) (Changing indoor discharge air temperature according to load)	○
	Outdoor Unit Control Refer to Humidity	ARUB06GSS4 only
	Defrost / Deicing	○
	High Pressure Switch	○
	Phase Protection	○
	Restart Delay (3-minutes)	○
	Self Diagnosis	○
	Soft Start	○
	Test Run Function	-
Central Controller	AC Ez (Simple Controller)	PQCSZ250S0
	AC Ez Touch	PACEZA000
	AC Smart IV	PACS4B000
	AC Smart 5	PACSSA000
	ACP (Advanced Control Platform) IV	PACP4B000
BNU (Building Network Unit)	ACP Lonworks	PLNWKB000
	ACP BACnet	PQNFB17C0
IO Module (ODU Dry Contact)	Standard	PVDSMN000
	Premium	PQNUD1S40
Cool / Heat Selector	Standard	PRDSBM
	Mobile LGMV	PRCTILO
Cycle Monitoring Device	Standard	PLGMVW100
	Mobile LGMV	PLGMVW100
Additional kit	Refrigerant Charging Kit	(Logical operation) Not applied to ARUB06GSS4
	Low Ambient Kit	-
	Variable Water Flow Valve Control Kit	-

※ ○ : Applied, - : Not Applied

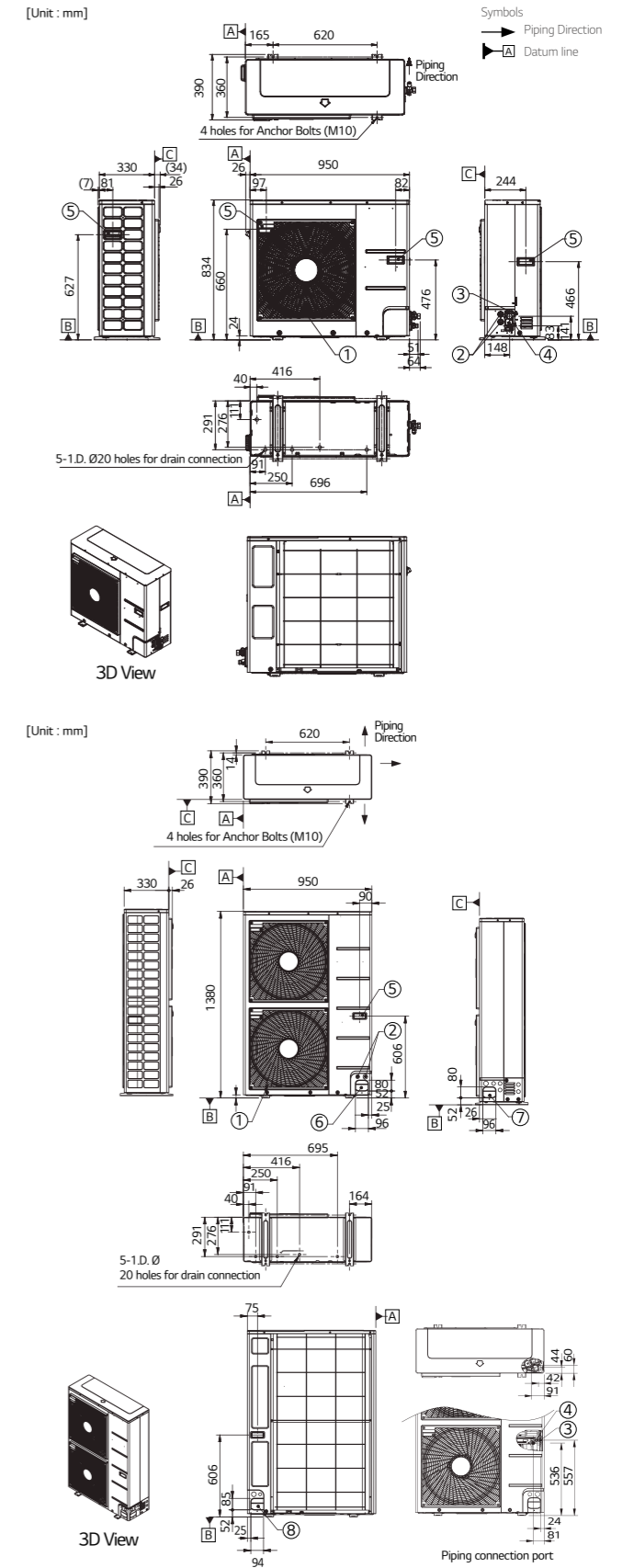

Note

- Unit should be installed in compliance with the installation manual in the product box
- Unit should be grounded in accordance with the local regulation or applicable national codes.
- All electrical components and materials to be supplied from the site must comply with the local regulations or international codes.
- Electrical characteristics chapter should be considered for electrical work and design. Especially the power cable and circuit breaker should be selected in accordance with that.

No.	Part Name	Description
1	Air Outlet	-
2	Power and communication cable Hole	-
3	Gas Pipe Connection	Welding joint
4	Liquid Pipe Connection	Welding joint
5	Handle	-
6	Pipe routing hole (front)	-
7	Pipe routing hole (side)	-
8	Pipe routing hole (back)	-

Heat Pump

Cooling

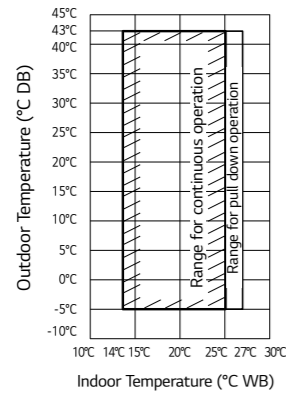

Heating

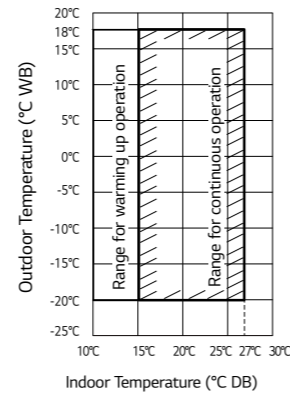

Heat Recovery

Cooling

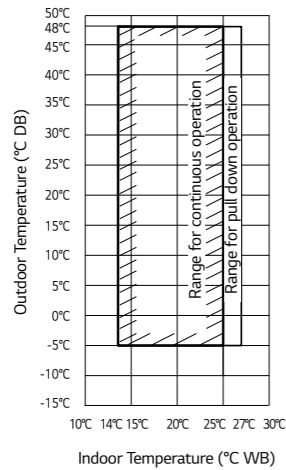

Heating

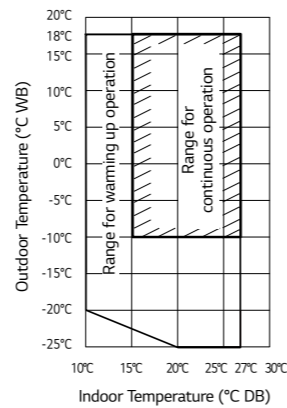

Simultaneous Cooling

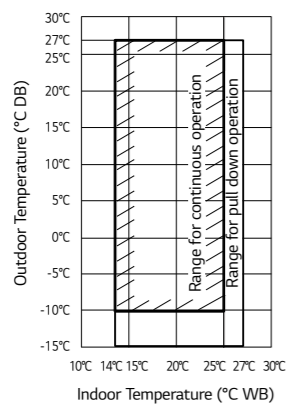

Simultaneous Heating

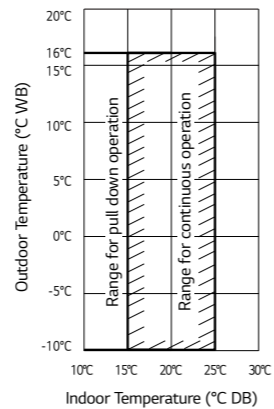

Note
 1. These figures assume the following operating conditions : Equivalent piping length : 7.5m
 Level difference : 0m
 2. Range of pull down operation : If the relative humidity is too high, cooling capacity can be decreased by the sensible

Position of Sound Level Measuring

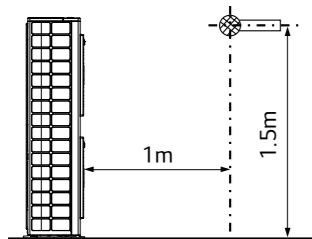

Note
 1. These figures assume the following operating conditions :
 Equivalent piping length : 7.5m
 Level difference : 0m

MULTI V S HEAT PUMP

ARUN040GSS0 / ARUN050GSL0



EUROVENT CERTIFIED PERFORMANCE
 LG participates in the ECP programme for EUROVENT VRF program. Check ongoing validity of certification : www.eurovent-certification.com

HP	4	5	
Model Name	ARUN040GSS0	ARUN050GSL0	
Capacity	Cooling (Rated) kW	12.1	14.0
	Heating (Rated) kW	12.5	15.0
Input	Cooling (Rated) kW	3.78	4.38
	Heating (Rated) kW	2.10	2.65
EER		3.20	3.20
SEER		5.98	6.60
COP Rated Capacity		5.9	5.7
SCOP		5.15	4.96
Exterior	Color (General)	Warm Gray	Warm Gray
	RAL Code (Classic)	RAL 7044	RAL 7044
Heat Exchanger	Type	Wide Louver Plus / Black Fin	Wide Louver Plus / Black Fin
	Type	BLDC Inverter Twin Rotary	BLDC Inverter Twin Rotary
Compressor	Combination x No.	(Inverter) x 1	(Inverter) x 1
	Motor Output x Number W x No.	4,000 x 1	4,000 x 1
Oil Type	Oil Type	FVC68D (PVE)	FVC68D (PVE)
	Oil Charge cc	1,300	1,300
Fan	Type	Axial Flow Fan	Axial Flow Fan
	Motor Output x Number W x No.	124 x 1	124 x 1
Air Flow Rate (High)	Air Flow Rate (High) m ³ /min x No.	60 x 1	60 x 1
	Drive	DC INVERTER	DC INVERTER
Discharge	Discharge	Side / Top	Side
	Liquid Pipe mm (inch)	Ø9.52 (3/8)	Ø9.52 (3/8)
Pipe Connection	Gas Pipe mm (inch)	Ø15.88 (5/8)	Ø15.88 (5/8)
	Dimensions (W x H x D)	mm x No.	(950 x 834 x 330) x 1
Dimensions (W x H x D) - Shipping	mm x No.	(1,065 x 918 x 461) x 1	(1,065 x 918 x 461) x 1
Net Weight	kg x No.	70 x 1	73 x 1
Shipping Weight	kg x No.	77 x 1	81 x 1
	Sound Pressure Level	Cooling dB(A)	50.0
Heating dB(A)		52.0	58.0
Sound Power Level	Cooling dB(A)	72.0	72.0
	Heating dB(A)	76.0	75.0
Communication Cable	mm ² x No. (VCTF-SB)	1.0 - 1.5 x 2C	1.0 - 1.5 x 2C
	Refrigerant	Refrigerant Name	R410A
Precharged Amount in factory kg		1.8	2.4
t-CO₂eq	t-CO ₂ eq	3.8	5.0
	Control	Electronic Expansion Valve	Electronic Expansion Valve
Power Supply	Ø, V, Hz	1, 220-240, 50	1, 220-240, 50
Number of Maximum Connectable Indoor Units		8	8*

* In case of ARUN050GSL0, maximum combination ratio is 130%.
 Note
 1. Eurovent Test Condition : Type of indoor unit connected is only Ceiling Concealed Duct.
 - Refer to EUROVENT certification regulation for more detail test conditions.
 - Refer to EUROVENT website for test values connected Ceiling Cassette type indoors.
 2. Performances are based on the following conditions :
 - Cooling Temperature : Indoor 27°C (80.6°F) DB / 19°C (66.2°F) WB / Outdoor 35°C (95°F) DB / 24°C (75.2°F) WB
 - Heating Temperature : Indoor 20°C (68°F) DB / 15°C (59°F) WB / Outdoor 7°C (44.6°F) DB / 6°C (42.8°F) WB
 3. The maximum combination ratio is 160%. (the maximum combination ratio of ARUN050GSL0 is 130%.)
 4. Wiring cable size must comply with the applicable local and national codes.
 5. Due to our policy of innovation some specifications may be changed without notification.
 6. Sound pressure level is measured on the rated condition in the anechoic rooms by ISO 3745 standard. Sound power level is measured on the rated condition in the reverberation rooms by ISO 3741 standard. Therefore, these values can be increased owing to ambient conditions during operation.
 7. Power factor could vary less than ±1% according to the operating conditions.
 8. This product contains Fluorinated greenhouse gases. (R410A, GWP(Global warming potential) = 2087.5)

MULTI V S HEAT PUMP

ARUN050GSS0 / ARUN060GSS0



LG participates in the ECP programme for EUROVENT VRF program. Check ongoing validity of certification : www.eurovent-certification.com

HP			5	6
Model Name			ARUN050GSS0	ARUN060GSS0
Capacity	Cooling (Rated)	kW	14.0	15.5
	Heating (Rated)	kW	16.0	18.0
Input	Cooling (Rated)	kW	3.33	3.97
	Heating (Rated)	kW	2.77	3.40
EER			4.20	3.90
SEER			6.56	6.65
COP Rated Capacity			5.77	5.30
SCOP			5.23	5.19
Exterior	Color (General)		Warm Gray	Warm Gray
	RAL Code (Classic)		RAL 7044	RAL 7044
Heat Exchanger	Type		Wide Louver Plus / Black Fin	Wide Louver Plus / Black Fin
	Type		BLDC Inverter Twin Rotary	BLDC Inverter Twin Rotary
Combination x No.			(Inverter) x 1	(Inverter) x 1
Compressor	Motor Output x Number	W x No.	4,000 x 1	4,000 x 1
	Oil Type		FVC68D (PVE)	FVC68D (PVE)
Oil Charge		cc	1,300	1,300
Fan	Type		Axial Flow Fan	Axial Flow Fan
	Motor Output x Number	W x No.	124 x 2	124 x 2
	Air Flow Rate (High)	m³/min x No.	110 x 1	110 x 1
	Drive		DC INVERTER	DC INVERTER
	Discharge		Side / Top	Side
Pipe Connection	Liquid Pipe	mm (inch)	Ø9.52 (3/8)	Ø9.52 (3/8)
	Gas Pipe	mm (inch)	Ø15.88 (5/8)	Ø19.05 (3/4)
Dimensions (W x H x D)		mm x No.	(950 x 1,380 x 330) x 1	(950 x 1,380 x 330) x 1
Dimensions (W x H x D) - Shipping		mm x No.	(1,140 x 1,462 x 461) x 1	(1,140 x 1,462 x 461) x 1
Net Weight		kg x No.	94 x 1	94 x 1
Shipping Weight		kg x No.	106 x 1	106 x 1
Sound Pressure Level	Cooling	dB(A)	51.0	52.0
	Heating	dB(A)	53.0	54.0
Sound Power Level	Cooling	dB(A)	72.0	72.0
	Heating	dB(A)	76.0	77.0
Communication Cable		mm² x No. (VCTF-SB)	1.0 ~ 1.5 x 2C	1.0 ~ 1.5 x 2C
Refrigerant	Refrigerant Name		R410A	R410A
	Precharged Amount in factory	kg	3.0	3.0
	t-CO ₂ eq		6.3	6.3
	Control		Electronic Expansion Valve	Electronic Expansion Valve
Power Supply		Ø, V, Hz	1, 220-240, 50	1, 220-240, 50
Number of Maximum Connectable Indoor Units			10	13

Note

- Eurovent Test Condition : Type of indoor unit connected is only Ceiling Concealed Duct.
 - Refer to EUROVENT certification regulation for more detail test conditions.
 - Refer to EUROVENT website for test values connected Ceiling Cassette type indoors.
- Performances are based on the following conditions :
 - Cooling Temperature : Indoor 27°C (80.6°F) DB / 19°C (66.2°F) WB / Outdoor 35°C (95°F) DB / 24°C (75.2°F) WB
 - Heating Temperature : Indoor 20°C (68°F) DB / 15°C (59°F) WB / Outdoor 7°C (44.6°F) DB / 6°C (42.8°F) WB
- The maximum combination ratio is 160%. (the maximum combination ratio of ARUN050GSS0 is 130%.)
- Wiring cable size must comply with the applicable local and national codes.
- Due to our policy of innovation some specifications may be changed without notification.
- Sound pressure level is measured on the rated condition in the anechoic rooms by ISO 3745 standard. Sound power level is measured on the rated condition in the reverberation rooms by ISO 3741 standard. Therefore, these values can be increased owing to ambient conditions during operation.
- Power factor could vary less than ±1% according to the operating conditions.
- This product contains Fluorinated greenhouse gases. (R410A, GWP(Global warming potential) = 2087.5)

MULTI V S HEAT PUMP

ARUN040LSS0 / ARUN050LSS0
ARUN060LSS0



LG participates in the ECP programme for EUROVENT VRF program. Check ongoing validity of certification : www.eurovent-certification.com

HP			4	5	6
Model Name			ARUN040LSS0	ARUN050LSS0	ARUN060LSS0
Capacity	Cooling (Rated)	kW	12.1	14.0	15.5
	Heating (Rated)	kW	12.5	16.0	18.0
Input	Cooling (Rated)	kW	2.37	3.33	3.97
	Heating (Rated)	kW	1.93	2.77	3.40
EER			5.10	4.20	3.90
SEER			6.46	6.56	6.65
COP Rated Capacity			6.49	5.77	5.30
SCOP			5.02	5.23	5.19
Exterior	Color (General)		Warm Gray	Warm Gray	Warm Gray
	RAL Code (Classic)		RAL 7044	RAL 7044	RAL 7044
Heat Exchanger	Type		Wide Louver Plus / Black Fin	Wide Louver Plus / Black Fin	Wide Louver Plus / Black Fin
	Type		BLDC Inverter Twin Rotary	BLDC Inverter Twin Rotary	BLDC Inverter Twin Rotary
Combination x No.			(Inverter) x 1	(Inverter) x 1	(Inverter) x 1
Compressor	Motor Output x Number	W x No.	4,000 x 1	4,000 x 1	4,000 x 1
	Oil Type		FVC68D (PVE)	FVC68D (PVE)	FVC68D (PVE)
Oil Charge		cc	1,300	1,300	1,300
Fan	Type		Axial Flow Fan	Axial Flow Fan	Axial Flow Fan
	Motor Output x Number	W x No.	124 x 2	124 x 2	124 x 2
	Air Flow Rate (High)	m³/min x No.	110 x 1	110 x 1	110 x 1
	Drive		DC INVERTER	DC INVERTER	DC INVERTER
	Discharge		Side / Top	Side	Side
Pipe Connection	Liquid Pipe	mm (inch)	Ø9.52 (3/8)	Ø9.52 (3/8)	Ø9.52 (3/8)
	Gas Pipe	mm (inch)	Ø15.88 (5/8)	Ø15.88 (5/8)	Ø19.05 (3/4)
Dimensions (W x H x D)		mm x No.	(950 x 1,380 x 330) x 1	(950 x 1,380 x 330) x 1	(950 x 1,380 x 330) x 1
Dimensions (W x H x D) - Shipping		mm x No.	(1,140 x 1,462 x 461) x 1	(1,140 x 1,462 x 461) x 1	(1,140 x 1,462 x 461) x 1
Net Weight		kg x No.	96 x 1	96 x 1	96 x 1
Shipping Weight		kg x No.	108 x 1	106 x 1	106 x 1
Sound Pressure Level	Cooling	dB(A)	50.0	51.0	52.0
	Heating	dB(A)	52.0	53.0	54.0
Sound Power Level	Cooling	dB(A)	72.0	72.0	72.0
	Heating	dB(A)	76.0	76.0	77.0
Communication Cable		mm² x No. (VCTF-SB)	1.0 ~ 1.5 x 2C	1.0 ~ 1.5 x 2C	1.0 ~ 1.5 x 2C
Refrigerant	Refrigerant Name		R410A	R410A	R410A
	Precharged Amount in factory	kg	3.0	3.0	3.0
	t-CO ₂ eq		6.3	6.3	6.3
	Control		Electronic Expansion Valve	Electronic Expansion Valve	Electronic Expansion Valve
Power Supply		Ø, V, Hz	3, 380-415, 50	3, 380-415, 50	3, 380-415, 50
Number of Maximum Connectable Indoor Units			8	10	13

Note

- Eurovent Test Condition : Type of indoor unit connected is only Ceiling Concealed Duct.
 - Refer to EUROVENT certification regulation for more detail test conditions.
 - Refer to EUROVENT website for test values connected Ceiling Cassette type indoors.
- Performances are based on the following conditions :
 - Cooling Temperature : Indoor 27°C (80.6°F) DB / 19°C (66.2°F) WB / Outdoor 35°C (95°F) DB / 24°C (75.2°F) WB
 - Heating Temperature : Indoor 20°C (68°F) DB / 15°C (59°F) WB / Outdoor 7°C (44.6°F) DB / 6°C (42.8°F) WB
- The maximum combination ratio is 160%. (the maximum combination ratio of ARUN050GSS0 is 130%.)
- Wiring cable size must comply with the applicable local and national codes.
- Due to our policy of innovation some specifications may be changed without notification.
- Sound pressure level is measured on the rated condition in the anechoic rooms by ISO 3745 standard. Sound power level is measured on the rated condition in the reverberation rooms by ISO 3741 standard. Therefore, these values can be increased owing to ambient conditions during operation.
- Power factor could vary less than ±1% according to the operating conditions.
- This product contains Fluorinated greenhouse gases. (R410A, GWP(Global warming potential) = 2087.5)

MULTI V S HEAT PUMP

ARUN080LSS0 / ARUN100LSS0
ARUN120LSS0



LG participates in the ECP programme for EUROVENT VRF program. Check ongoing validity of certification : www.eurovent-certification.com

HP			8	10	12	
Model Name			ARUN080LSS0	ARUN100LSS0	ARUN120LSS0	
Capacity	Cooling (Rated)	kW	22.4	28.0	33.6	
	Heating (Rated)	kW	24.5	30.6	36.7	
Input	Cooling (Rated)	kW	8.30	8.75	14.00	
	Heating (Rated)	kW	6.62	8.12	7.46	
EER			2.70	3.20	2.40	
SEER			6.03	6.59	5.72	
COP Rated Capacity			3.70	3.77	4.92	
SCOP			4.33	4.17	3.86	
Exterior	Color (General)		Warm Gray	Warm Gray	Warm Gray	
	RAL Code (Classic), General		RAL 7044	RAL 7044	RAL 7044	
Heat Exchanger	Type		Wide Louver Plus / Black Fin	Wide Louver Plus / Black Fin	Wide Louver Plus / Black Fin	
	Type		Hermetically Sealed Scroll	Hermetically Sealed Scroll	Hermetically Sealed Scroll	
	Combination x No.		(Inverter) x 1	(Inverter) x 1	(Inverter) x 1	
Compressor	Motor Output x Number	W x No.	4,200 x 1	5,300 x 1	5,300 x 1	
	Oil Type		FVC68D (PVE)	FVC68D (PVE)	FVC68D (PVE)	
	Oil Charge		cc	2,400	2,600	3,400
Fan	Type		Propeller fan	Propeller fan	Propeller fan	
	Motor Output x Number	W x No.	124 x 2	250 x 2	250 x 2	
	Air Flow Rate (High)	m ³ /min x No.	140 x 1	190 x 1	190 x 1	
	Drive		DC INVERTER	DC INVERTER	DC INVERTER	
	Discharge		Side / Top	Side	Side	
Pipe Connection	Liquid Pipe	mm (inch)	Ø9.52 (3/8)	Ø9.52 (3/8)	Ø12.7 (1/2)	
	Gas Pipe	mm (inch)	Ø19.05 (3/4)	Ø22.2 (7/8)	Ø28.58 (1-1/8)	
Dimensions (W x H x D)			mm x No.	(950 x 1,380 x 330) x 1	(1,090 x 1,625 x 380) x 1	(1,090 x 1,625 x 380) x 1
Dimensions (W x H x D) - Shipping			mm x No.	(1,140 x 1,462 x 461) x 1	(1,215 x 1,795 x 500) x 1	(1,215 x 1,795 x 500) x 1
Net Weight			kg x No.	115 x 1	144 x 1	157 x 1
Shipping Weight			kg x No.	127 x 1	160 x 1	173 x 1
Sound Pressure Level	Cooling	dB(A)	57.0	58.0	60.0	
	Heating	dB(A)	57.0	58.0	60.0	
Sound Power Level	Cooling	dB(A)	81.0	80.0	81.0	
	Heating	dB(A)	84.0	84.0	85.0	
Communication Cable			mm ² x No. (VCTF-SB)	1.0 - 1.5 x 2C	1.0 - 1.5 x 2C	1.0 - 1.5 x 2C
Refrigerant	Refrigerant Name		R410A	R410A	R410A	
	Precharged Amount in factory	kg	3.5	4.5	6.0	
	t-CO ₂ eq		7.3	9.4	12.5	
	Control		Electronic Expansion Valve	Electronic Expansion Valve	Electronic Expansion Valve	
Power Supply			Ø, V, Hz	3, 380-415, 50	3, 380-415, 50	3, 380-415, 50
Number of Maximum Connectable Indoor Units				13	16	20

Note

- Eurovent Test Condition : Type of indoor unit connected is only Ceiling Concealed Duct.
 - Refer to EUROVENT certification regulation for more detail test conditions.
 - Refer to EUROVENT website for test values connected Ceiling Cassette type indoors.
- Performances are based on the following conditions :
 - Cooling Temperature : Indoor 27°C (80.6°F) DB / 19°C (66.2°F) WB / Outdoor 35°C (95°F) DB / 24°C (75.2°F) WB
 - Heating Temperature : Indoor 20°C (68°F) DB / 15°C (59°F) WB / Outdoor 7°C (44.6°F) DB / 6°C (42.8°F) WB
- The maximum combination ratio is 160%. (the maximum combination ratio of ARUN050GSL0 is 130%.)
- Wiring cable size must comply with the applicable local and national codes.
- Due to our policy of innovation some specifications may be changed without notification.
- Sound pressure level is measured on the rated condition in the anechoic rooms by ISO 3745 standard. Sound power level is measured on the rated condition in the reverberation rooms by ISO 3741 standard. Therefore, these values can be increased owing to ambient conditions during operation.
- Power factor could vary less than ±1% according to the operating conditions.
- This product contains Fluorinated greenhouse gases. (R410A, GWP(Global warming potential) = 2087.5)

MULTI V S HEAT RECOVERY

ARUB060GSS4



LG participates in the ECP programme for EUROVENT VRF program. Check ongoing validity of certification : www.eurovent-certification.com

HP			6	
Model Name			ARUB060GSS4	
Capacity	Cooling (Rated)	kW	15.5	
	Heating (Rated)	kW	18.0	
Input	Cooling (Rated)	kW	3.97	
	Heating (Rated)	kW	4.10	
EER			3.90	
SEER			6.84	
COP Rated Capacity			4.39	
SCOP			4.38	
Exterior	Color		Warm Gray	
	RAL Code (Classic)		RAL 7044	
Heat Exchanger	Type		Wide Louver Plus	
	Type		Hermetically Sealed Scroll	
	Combination x No.		(Inverter) x 1	
Compressor	Motor Output x Number	W x No.	4,200 x 1	
	Oil Type		FVC68D (PVE)	
	Oil Charge		cc	1,700
Fan	Type		Axial Flow Fan	
	Motor Output x Number	W x No.	124 x 2	
	Air Flow Rate (High)	m ³ /min x No.	110 x 1	
	Drive		DC INVERTER	
	Discharge		Side / Top	
Pipe Connection #1	Liquid Pipe	mm (inch)	Ø9.52 (3/8)	
	Low Pressure Gas Pipe	mm (inch)	Ø19.05 (3/4)	
	High Pressure Gas Pipe	mm (inch)	Ø15.88 (5/8)	
Dimensions (W x H x D)			mm x No.	(950 x 1,380 x 330) x 1
Dimensions (W x H x D) - shipping			mm x No.	(1,140 x 1,549 x 466) x 1
Net Weight			kg x No.	118 x 1
Shipping Weight			kg x No.	132 x 1
Sound Pressure Level	Cooling	dB(A)	56.0	
	Heating	dB(A)	58.0	
Sound Power Level	Cooling	dB(A)	76.0	
	Heating	dB(A)	78.0	
Communication Cable			mm ² x No. (VCTF-SB)	1.0 - 1.5 x 2C
Refrigerant	Refrigerant Name		R410A	
	Precharged Amount in factory	kg	3.5	
	t-CO ₂ eq		7.3	
	Control		Electronic Expansion Valve	
Power Supply			Ø, V, Hz	1, 220-240, 50
Number of Maximum Connectable Indoor Units				13

Note

- Eurovent Test Condition : Type of indoor unit connected is only Ceiling Concealed Duct.
 - Refer to EUROVENT certification regulation for more detail test conditions.
 - Refer to EUROVENT website for test values connected Ceiling Cassette type indoors.
- Performances are based on the following conditions :
 - Cooling Temperature : Indoor 27°C (80.6°F) DB / 19°C (66.2°F) WB / Outdoor 35°C (95°F) DB / 24°C (75.2°F) WB
 - Heating Temperature : Indoor 20°C (68°F) DB / 15°C (59°F) WB / Outdoor 7°C (44.6°F) DB / 6°C (42.8°F) WB
- The maximum combination ratio is 160%. (the maximum combination ratio of ARUN050GSL0 is 130%.)
- Wiring cable size must comply with the applicable local and national codes.
- Due to our policy of innovation some specifications may be changed without notification.
- Sound pressure level is measured on the rated condition in the anechoic rooms by ISO 3745 standard. Sound power level is measured on the rated condition in the reverberation rooms by ISO 3741 standard. Therefore, these values can be increased owing to ambient conditions during operation.
- Power factor could vary less than ±1% according to the operating conditions.
- This product contains Fluorinated greenhouse gases. (R410A, GWP(Global warming potential) = 2087.5)

MULTI V S

Energy Savings

Energy consumption can be reduced as indoor heat is absorbed and transferred to hot water supply.

Conventional

Absorbed heat is released to outdoor air.

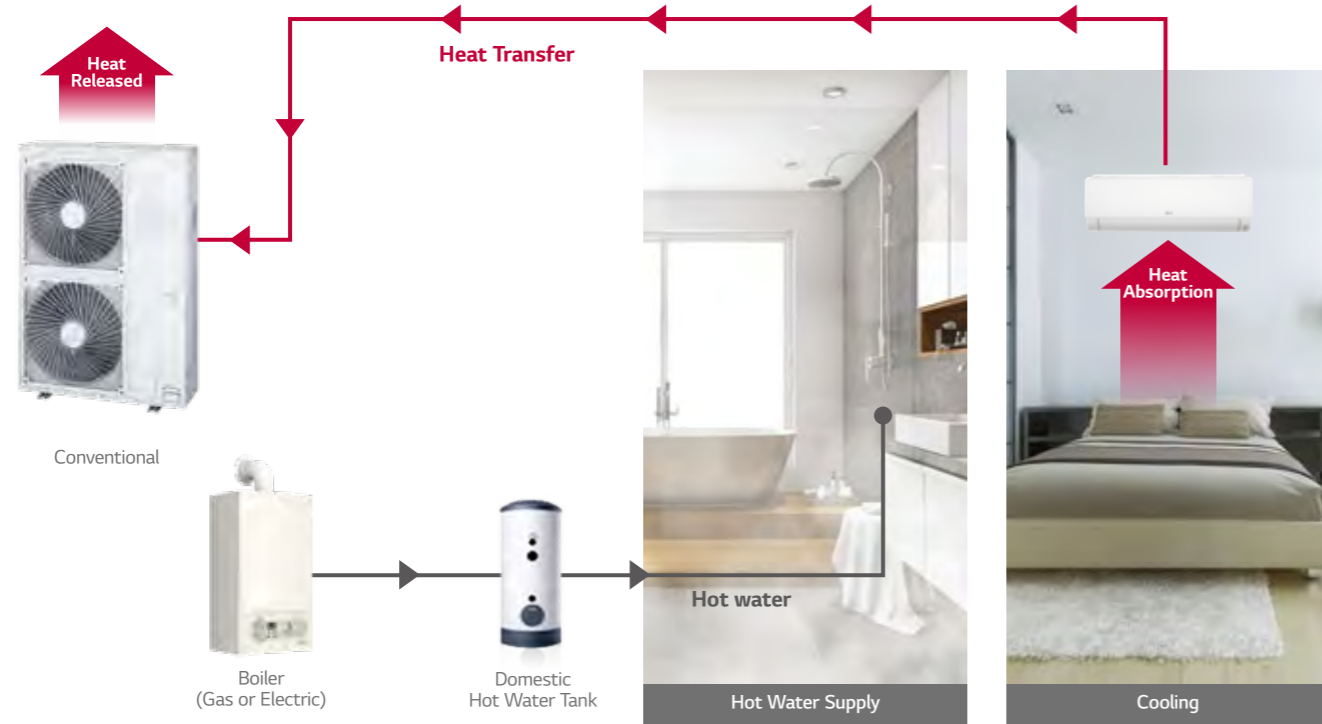

MULTI V S

Energy Savings

Energy consumption can be reduced as indoor heat is absorbed and transferred to hot water supply.

MULTI V S Heat Recovery with HYDRO KIT

Absorbed heat from indoor space is used for making hot water.

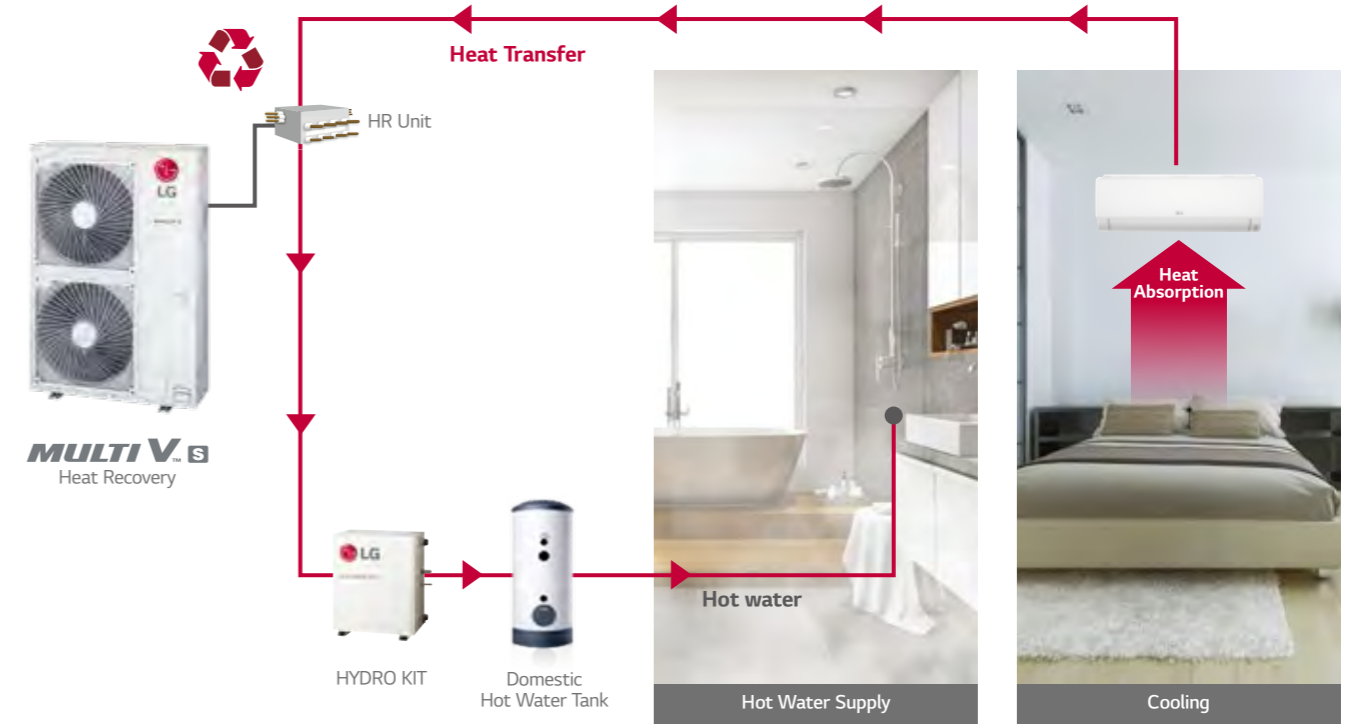

MULTI V S R32

- Air cooled VRF Heat pump
- 12.1 ~ 15.5kW (Cooling capacity based)
- Both 1Ø, 220 ~ 240V, 50Hz and 3Ø, 380 ~ 415V, 50Hz
- Side discharge outdoor unit

WHY R32 REFRIGERANT?

Low global warming potential (GWP)

What is GWP?

Global warming potential is a measure that allows for an accurate comparison of the environmental impact of different gases. GWP measures how much energy the emissions of 1 ton of a gas will absorb over a given period of time, relative to the emissions of 1 ton of carbon dioxide (CO₂).

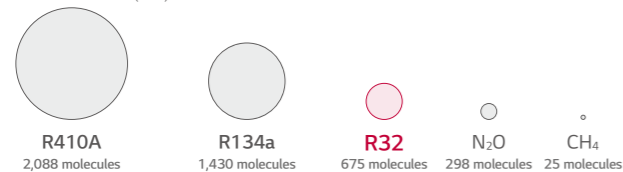

Global Trend and EU Regulation for F-Gas

HFC* Phase Down 79% by 2030

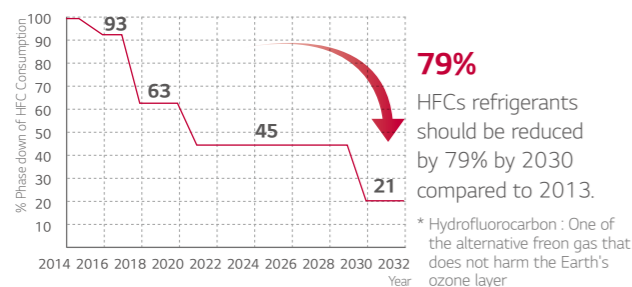

Cost Savings with R32

Higher Efficiency

Savings on cost of energy consumption.



Reduced Equipment Sizes

Savings on product purchase and labor cost for installation and maintenance.



Less Refrigerant Charge

Savings on cost of injecting & replacing refrigerant.



Reduced Refrigerant Volume

Savings on refrigerant purchase and recycling costs.



WHY MULTI V S R32?

Higher Efficiency

LG Multi V S achieved high efficiency through technology of biomimetic fan and revolutionary scroll compressor



※ The values based on 5HP model

Compact Size & Light Weight

Its compact size and light weight make it easy to install and optimize space. (5/6HP)

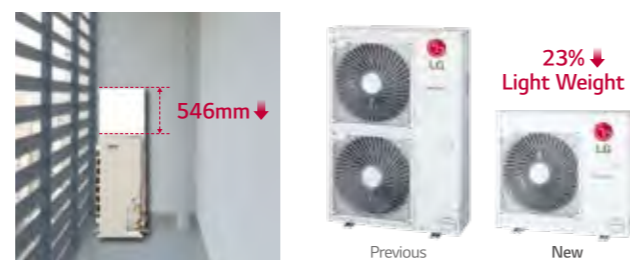

Less Refrigerant Charge

LG reduced refrigerant charge by applying environment-friendly refrigerant R32.



Corrosion Resistance Black Fin

The black coating with enhanced epoxy resin is applied for strong protection from various corrosive external conditions.

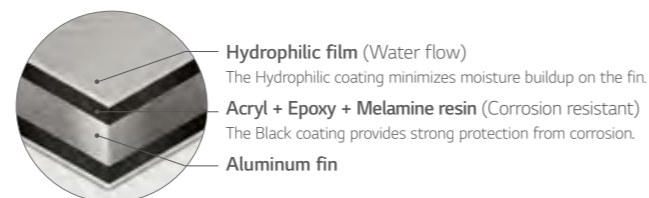

INNOVATIVE TECHNOLOGIES



R1 Compressor™

R1 Compressor is one that combines high-efficiency, low sound characteristics of the scroll and the simple compressing structure of the rotary compressor. This technology enables a highly efficient compact model.

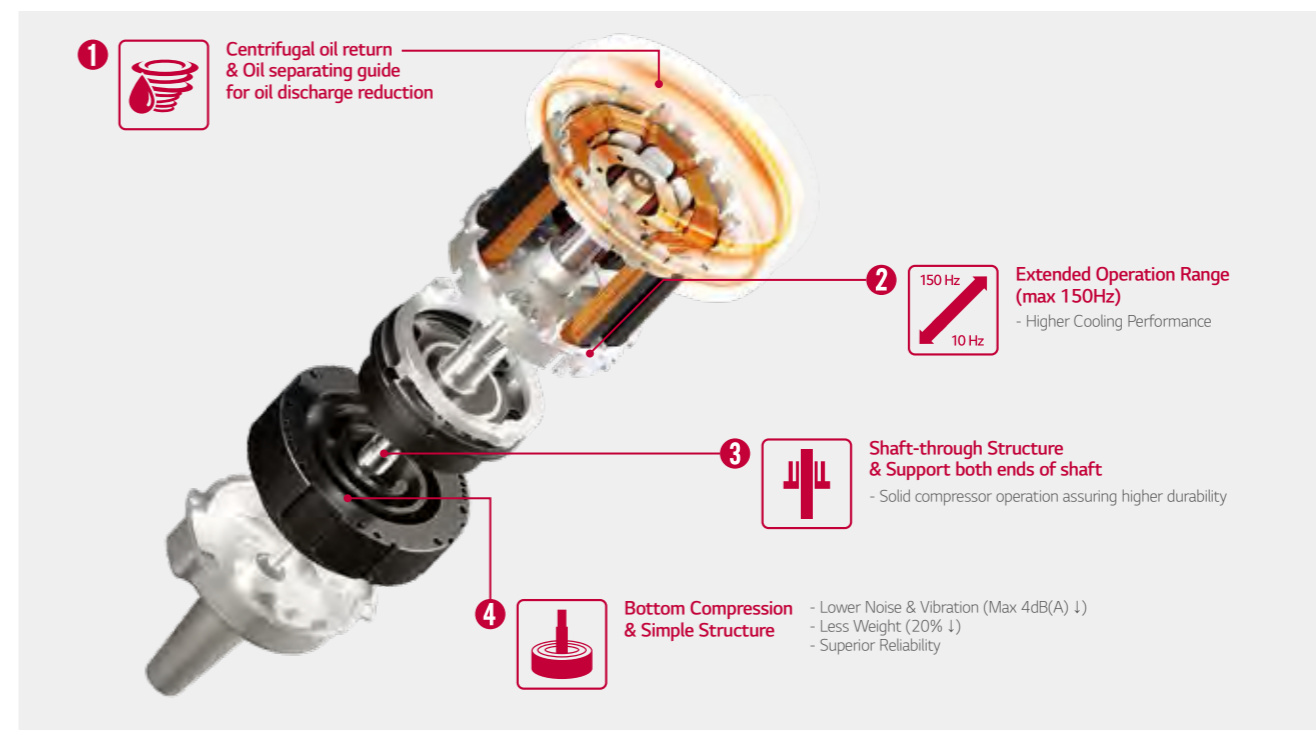

Conventional Compressor

Scroll : High efficiency / Low sound
(Continuous compression, but complex structure)

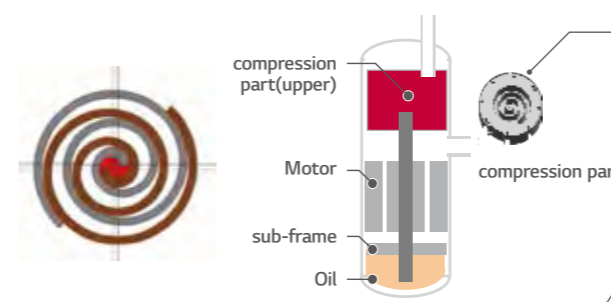

Rotary : Simple structure

(Compression per 1 rotation)

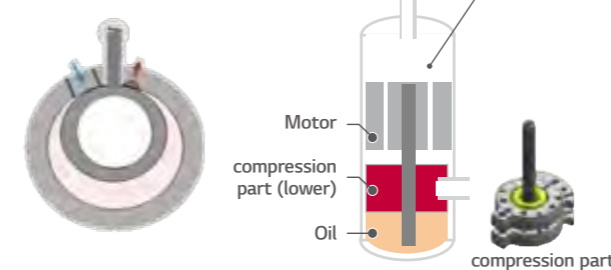

R1 Compressor™

Revolutionary Scroll : High efficiency / Stable & Simple Structure

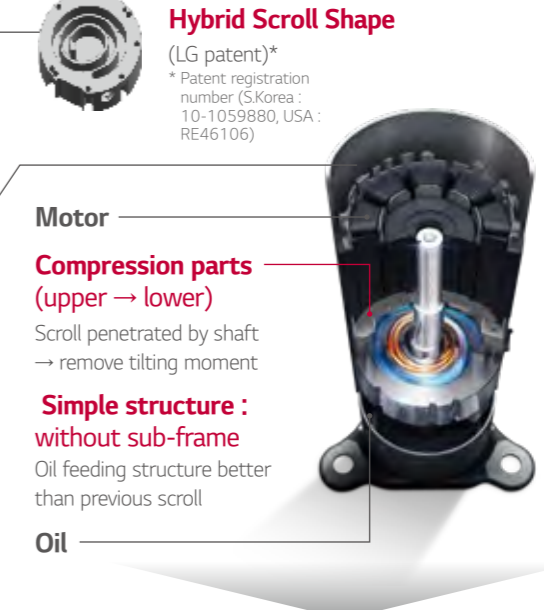

Extended operation (Max 150Hz)
Low noise & Vibration (Max 4dB(A) ↓)
Less weight (20% ↓)

Compact model
(Size 40% ↓, Weight 25% ↓)



MULTI V S HEAT PUMP R32

ZRUN040GSS0 / ZRUN050GSS0
ZRUN060GSS0



LG participates in the ECP programme for EUROVENT VRF program. Check ongoing validity of certification : www.eurovent-certification.com

HP			4	5	6
Model Name			ZRUN040GSS0	ZRUN050GSS0	ZRUN060GSS0
Capacity	Cooling (Rated)	kW	12.1	14.0	15.5
	Heating (Rated)	kW	12.1	14.0	15.5
	Heating (Max)	kW	14.2	16.0	18.0
Input	Cooling (Rated)	kW	3.43	3.33	3.97
	Heating (Rated)	kW	2.30	2.72	3.23
	Heating (Max)	kW	2.93	3.48	4.29
EER (Rated)			3.53	4.20	3.90
SEER			8.10	8.70	8.50
COP (Rated)			5.26	5.15	4.80
COP (Max)			4.84	4.60	4.20
SCOP			4.70	4.80	5.00
Exterior	Color		Warm Gray	Warm Gray	Warm Gray
	RAL Code		RAL 7044	RAL 7044	RAL 7044
Heat Exchanger			Wide Louver Plus / Black Fin	Wide Louver Plus / Black Fin	Wide Louver Plus / Black Fin
Compressor	Type		LG Inverter Scroll (R1)	LG Inverter Scroll (R1)	LG Inverter Scroll (R1)
	Combination x No.		(Inverter) x 1	(Inverter) x 1	(Inverter) x 1
	Motor Output x Number	W x No.	3,198 x 1	3,198 x 1	3,198 x 1
	Oil Type		FW68D	FW68D	FW68D
	Oil Charge	cc	1,100	1,100	1,100
Fan	Type		Axial Flow Fan	Axial Flow Fan	Axial Flow Fan
	Motor Output x Number	W x No.	124 x 1	200 x 1	200 x 1
	Air Flow Rate (High)	m ³ /min x No.	60 x 1	80 x 1	80 x 1
	Drive		DC INVERTER	DC INVERTER	DC INVERTER
	Discharge	Side / Top	Side	Side	Side
Pipe Connection	Liquid Pipe	mm (inch)	Ø9.52 (3/8)	Ø9.52 (3/8)	Ø9.52 (3/8)
	Gas Pipe	mm (inch)	Ø15.88 (5/8)	Ø15.88 (5/8)	Ø19.05 (3/4)
Dimensions (W x H x D)			(950 x 834 x 330) x 1	(950 x 834 x 330) x 1	(950 x 834 x 330) x 1
Dimensions (W x H x D) - Shipping			(1,147 x 919 x 461) x 1	(1,147 x 919 x 461) x 1	(1,147 x 919 x 461) x 1
Net Weight			64.7 x 1	71.6 x 1	71.6 x 1
Shipping Weight			73.7 x 1	79.6 x 1	79.6 x 1
Sound Pressure Level	Cooling	dB(A)	50	51	52
	Heating	dB(A)	52	53	54
Sound Power Level	Cooling	dB(A)	67	70	71
	Heating	dB(A)	71	74	75
Communication Cable			1.0 - 1.5 x 2C	1.0 - 1.5 x 2C	1.0 - 1.5 x 2C
Refrigerant	Refrigerant name		R32	R32	R32
	Precharged Amount	kg	1.5	2.0	2.0
	t-CO ₂ eq		1.01	1.35	1.35
	Control		Electronic Expansion Valve	Electronic Expansion Valve	Electronic Expansion Valve
Power Supply			Ø, V, Hz	1, 220-240, 50	1, 220-240, 50
Number of maximum connectable indoor units			8	10	13

Note

- Due to our policy of innovation some specifications may be changed without notification.
- Wiring cable size must comply with the applicable local and national codes. And "Electric characteristics" chapter should be considered for electrical work and design. Especially the power cable and circuit breaker should be selected in accordance with that.
- Sound pressure level is measured on the rated condition in the anechoic rooms by ISO 3745 standard. Sound power level is measured on the rated condition in the reverberation rooms by ISO 3741 standard. Therefore, these values can be increased owing to ambient conditions during operation.

4. Performances are based on the following conditions :

- Cooling : Indoor Ambient Temp 27°CDB / 19°CWB, Outdoor Ambient Temp 35°CDB / 24°CWB
- Heating : Indoor Ambient Temp 20°CDB / 15°CWB, Outdoor Ambient Temp 7°CDB / 6°CWB
- Interconnected Pipe Length is 7.5m and difference of Elevation (Outdoor - Indoor Unit) is 0m.
- EUROVENT Test Condition :
- Performance values on the this PDB are based on Ceiling mounted cassette combination.
- Refer to EUROVENT web site(www.eurovent-certification.com) for other indoor unit combination and more detail test conditions.
- The maximum combination ratio is 160%.
- This product contains Fluorinated greenhouse gases.

MULTI V S HEAT PUMP R32

ZRUN040LSS0 / ZRUN050LSS0
ZRUN060LSS0



LG participates in the ECP programme for EUROVENT VRF program. Check ongoing validity of certification : www.eurovent-certification.com

HP			4	5	6
Model Name			ZRUN040LSS0	ZRUN050LSS0	ZRUN060LSS0
Capacity	Cooling (Rated)	kW	12.1	14.0	15.5
	Heating (Rated)	kW	12.1	14.0	15.5
	Heating (Max)	kW	14.2	16.0	18.0
Input	Cooling (Rated)	kW	3.43	3.33	3.97
	Heating (Rated)	kW	2.30	2.72	3.23
	Heating (Max)	kW	2.93	3.48	4.29
EER (Rated)			3.53	4.20	3.90
SEER			8.10	8.70	8.50
COP (Rated)			5.26	5.15	4.80
COP (Max)			4.84	4.60	4.20
SCOP			4.70	4.80	5.00
Exterior	Color		Warm Gray	Warm Gray	Warm Gray
	RAL Code		RAL 7044	RAL 7044	RAL 7044
Heat Exchanger			Wide Louver Plus / Black Fin	Wide Louver Plus / Black Fin	Wide Louver Plus / Black Fin
Compressor	Type		LG Inverter Scroll (R1)	LG Inverter Scroll (R1)	LG Inverter Scroll (R1)
	Combination x No.		(Inverter) x 1	(Inverter) x 1	(Inverter) x 1
	Motor Output x Number	W x No.	3,198 x 1	3,198 x 1	3,198 x 1
	Oil Type		FW68D	FW68D	FW68D
	Oil Charge	cc	1,100	1,100	1,100
Fan	Type		Axial Flow Fan	Axial Flow Fan	Axial Flow Fan
	Motor Output x Number	W x No.	124 x 1	200 x 1	200 x 1
	Air Flow Rate (High)	m ³ /min x No.	60 x 1	80 x 1	80 x 1
	Drive		DC INVERTER	DC INVERTER	DC INVERTER
	Discharge	Side / Top	Side	Side	Side
Pipe Connection	Liquid Pipe	mm (inch)	Ø9.52 (3/8)	Ø9.52 (3/8)	Ø9.52 (3/8)
	Gas Pipe	mm (inch)	Ø15.88 (5/8)	Ø15.88 (5/8)	Ø19.05 (3/4)
Dimensions (W x H x D)			(950 x 834 x 330) x 1	(950 x 834 x 330) x 1	(950 x 834 x 330) x 1
Dimensions (W x H x D) - Shipping			(1,147 x 919 x 461) x 1	(1,147 x 919 x 461) x 1	(1,147 x 919 x 461) x 1
Net Weight			64.7 x 1	71.6 x 1	71.6 x 1
Shipping Weight			73.7 x 1	79.6 x 1	79.6 x 1
Sound Pressure Level	Cooling	dB(A)	50	51	52
	Heating	dB(A)	52	53	54
Sound Power Level	Cooling	dB(A)	67	70	71
	Heating	dB(A)	71	74	75
Communication Cable			1.0 - 1.5 x 2C	1.0 - 1.5 x 2C	1.0 - 1.5 x 2C
Refrigerant	Refrigerant name		R32	R32	R32
	Precharged Amount	kg	1.5	2.0	2.0
	t-CO ₂ eq		1.01	1.35	1.35
	Control		Electronic Expansion Valve	Electronic Expansion Valve	Electronic Expansion Valve
Power Supply			Ø, V, Hz	3, 380-415, 50	3, 380-415, 50
Number of maximum connectable indoor units			8	10	13

Note

- Due to our policy of innovation some specifications may be changed without notification.
- Wiring cable size must comply with the applicable local and national codes. And "Electric characteristics" chapter should be considered for electrical work and design. Especially the power cable and circuit breaker should be selected in accordance with that.
- Sound pressure level is measured on the rated condition in the anechoic rooms by ISO 3745 standard. Sound power level is measured on the rated condition in the reverberation rooms by ISO 3741 standard. Therefore, these values can be increased owing to ambient conditions during operation.

4. Performances are based on the following conditions :

- Cooling : Indoor Ambient Temp 27°CDB / 19°CWB, Outdoor Ambient Temp 35°CDB / 24°CWB
- Heating : Indoor Ambient Temp 20°CDB / 15°CWB, Outdoor Ambient Temp 7°CDB / 6°CWB
- Interconnected Pipe Length is 7.5m and difference of Elevation (Outdoor - Indoor Unit) is 0m.
- EUROVENT Test Condition :
- Performance values on the this PDB are based on Ceiling mounted cassette combination.
- Refer to EUROVENT web site(www.eurovent-certification.com) for other indoor unit combination and more detail test conditions.
- The maximum combination ratio is 160%.
- This product contains Fluorinated greenhouse gases."

MULTI V™ M

- Air Cooled VRF Heat Pump
- 14kW (Cooling capacity based)
- 3Ø, 380 ~ 415V, 50Hz (Compressor Module)
- 1Ø, 220 ~ 240V, 50Hz (Heat Exchanger Module)
- Outdoor unit is installed inside building

140M
TOTAL PIPING LENGTH

Concealed VRF technology for enhanced flexibility and aesthetic building requirements

70m
Longest piping length from Compressor Module to Indoor unit

140m
TOTAL PIPING LENGTH

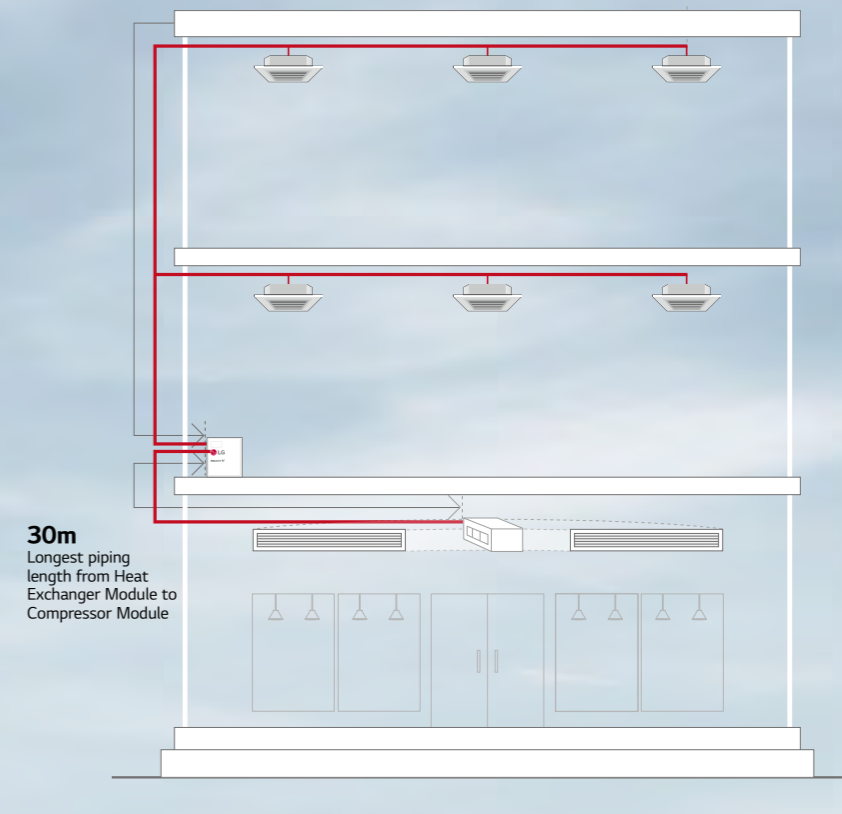

30m
Longest piping length from Heat Exchanger Module to Compressor Module



Flexible design



Cost savings



Space savings



Easy maintenance

How does it work?

Direct Inlet / Outlet Case

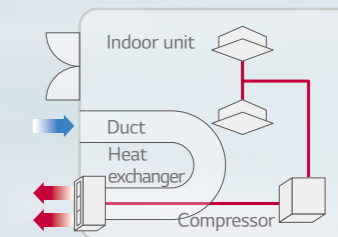

Duct Connected Case

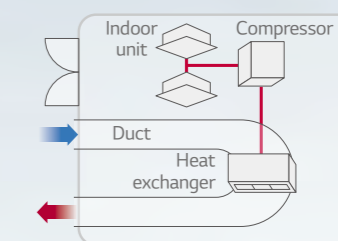

HIGH CLASS EFFICIENCY

Best-in-class inverter compressor with smart load control and Wide Louver Plus fin technology

Energy Efficiency

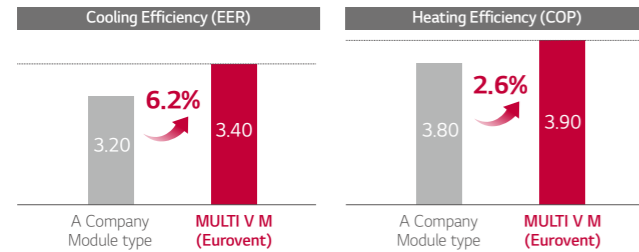

R1 Compressor

MULTI V M ensures world-class efficiency with innovative technology including R1 Compressor.

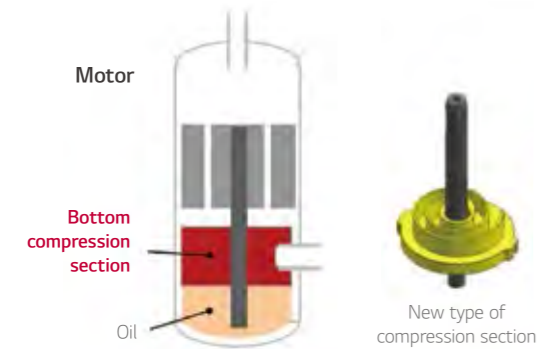

Smart Load Control

To save operation energy consumption, automatically controls the refrigerant temperature according to outdoor temperature.

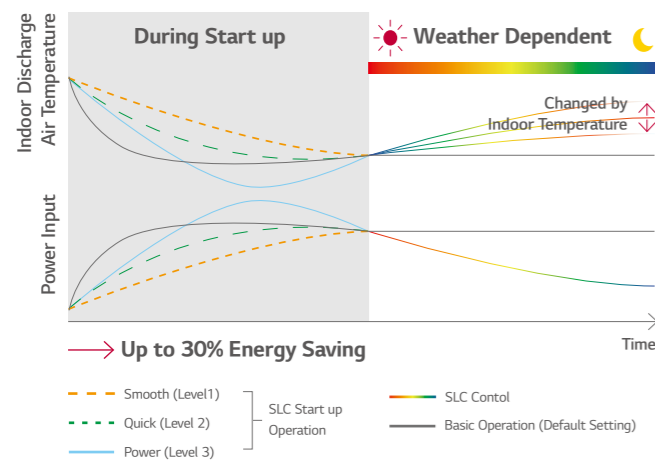
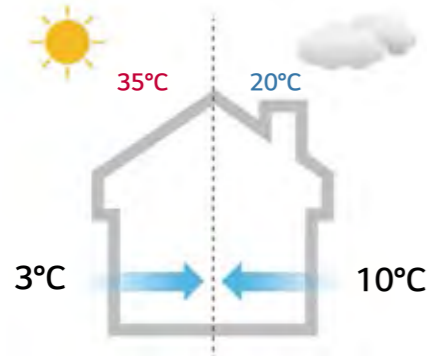

Wide Louver Plus Fin + Corrosion Resistance

Wide Louver Plus fin technology increases efficiency and heating performance compared to conventional fin.

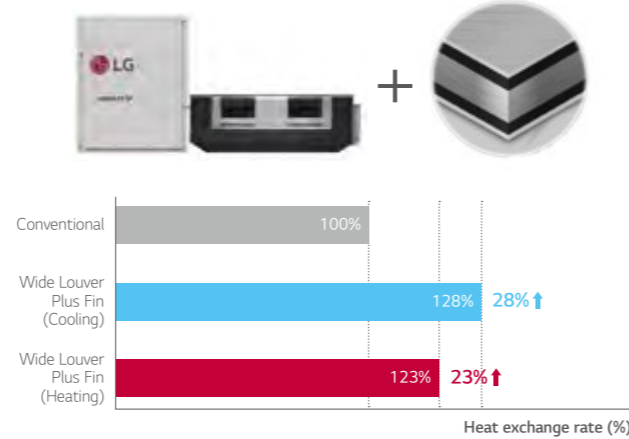

Quiet Operation

Low sound level of both compressor module and heat exchanger module allows outdoor units to be installed and operated inside.



REGULATORY COMPLIANCE

Building permit could be simplified

Regulation in Spain



- Can only be installed inside the building
- Discharge air volume less than 60CMM
- Securing more than 5m distance between outdoor discharge grilles
- Securing at least 2.5m from the floor
- Securing more than 2.5m from surrounding windows

FLEXIBLE DESIGN & INSTALLATION

Module Type

- Increased design freedom
 - Additional structure installation and ceiling construction not required
 - Ease of service - compressor replacement
 - Low noise with module
- Ease of service (Replacement of the comp)
- Low noise by module (vs Integrated Type)

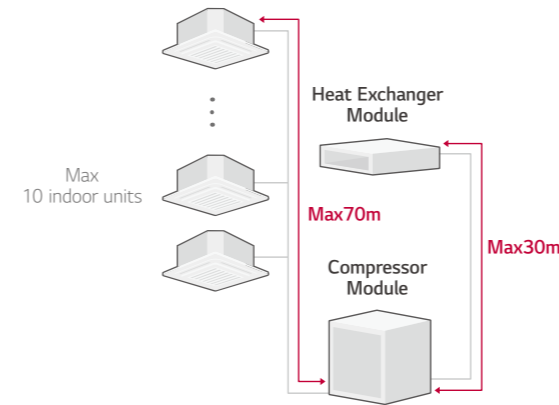

Flexible Piping Location

Tidy & simple installation with flexible piping location.

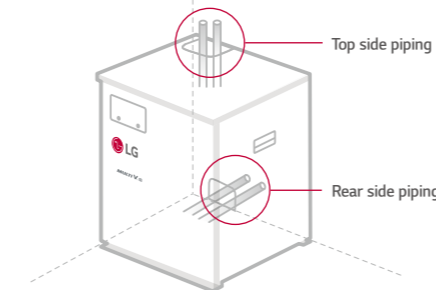

Increased design freedom

Additional structure installation nor ceiling construction not required, making compressor replacement and general maintenance easier. Split module provides low noise operation compared to integrated type.



Heat exchanger module can be installed in false ceiling spaces



Compressor module can be installed anywhere indoors



SPACE SAVING & CONVENIENT INSTALLATION

Volume

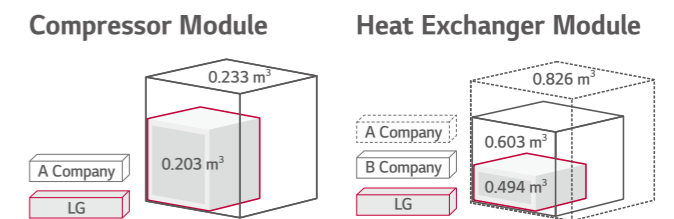

ESP (External Static Pressure) Control



Nomenclature

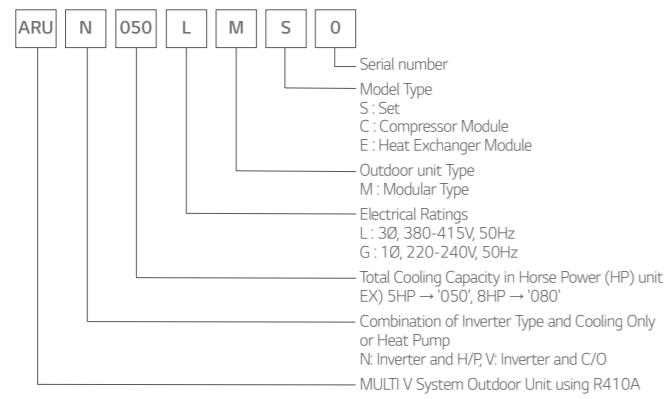

Outdoor Units Function

Category	Functions	Modular
Key Refrigerant Components	Variable Path of Outdoor Unit HEX	-
	HiPOT™ (High Pressure Oil Return)	-
	Humidity Sensor	-
	Corrosion Resistance Black Fin	○
Useful Function	Oil Sensor	-
	Dual Sensing	-
	Low Noise Operation	○
	High Static Mode of Outdoor Unit Fan	○
	Partial Defrosting	-
	Auto Dust Cleaning of Outdoor Unit (Fan reverse rotation)	-
	Indoor Cooling Comfort Mode Based Outdoor Temperature	○
	Smart Load Control (SLC) (Changing indoor discharge air temperature according to load)	○
	Outdoor Unit Control Refer to Humidity	-
	Defrost / Deicing	○
Reliability	High Pressure Switch	○
	Phase Protection	○
	Restart Delay (3-minutes)	○
	Self Diagnosis	○
Central Controller	Soft Start	○
	Test Run Function	-
	AC Ez (Simple Controller)	PQCSZ250S0
	AC Ez Touch	PACEZA000
	AC Smart IV	PACS4B000
	AC Smart 5	PACS5A000
	ACP (Advanced Control Platform) IV	PACP4B000
	ACP (Advanced Control Platform) 5	PACP5A000
	AC Manager 5	PACM5A000
	ACP Lonworks	PLNWKB000
BNU (Building Network Unit)	ACP BACnet	PQNFB17C0
	Refrigerant Charging Kit	-
Installation	Variable Water Flow Valve Control Kit	-
	Standard	-
PDI (Power Distribution Indicator)	Premium	-
	Cool / Heat Selector	PRDSBM
Low Ambient Kit	-	-
IO Module (ODU Dry Contact)	-	PVDSMN000
Cycle Monitoring Device	LGMV	PRCTILO
	Mobile LGMV	PLGMVV100

※ ○ : Applied, - : Not Applied

Heat Pump

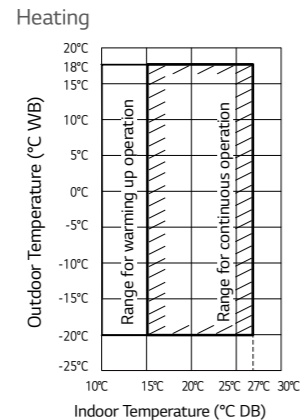
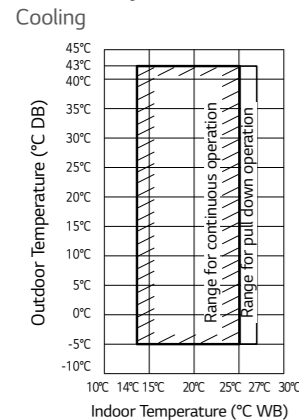

Compressor Module

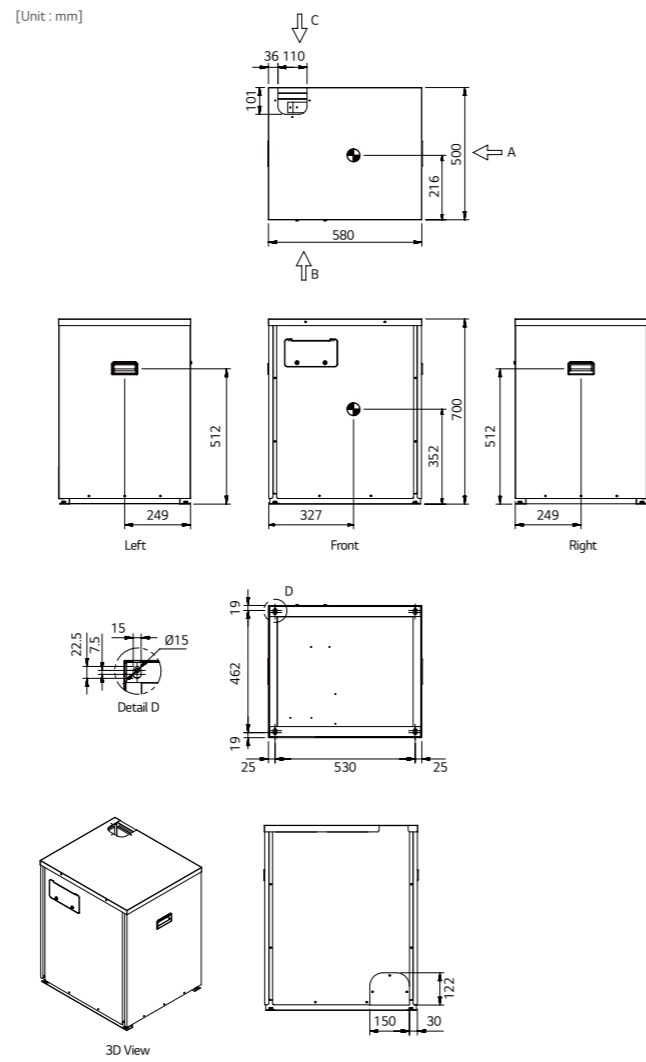

Heat Exchanger Module

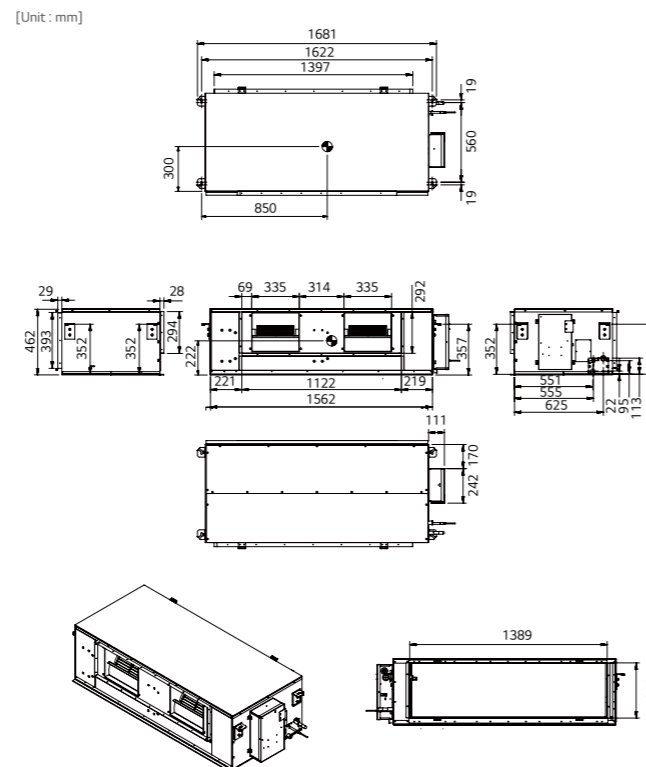

Position of Sound Pressure Level Measuring

Compressor Module

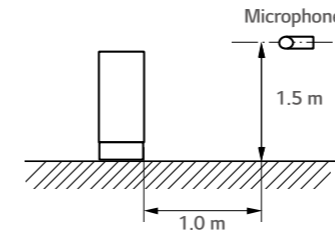

※ Measuring place : Anechoic chamber

Heat Exchanger Module

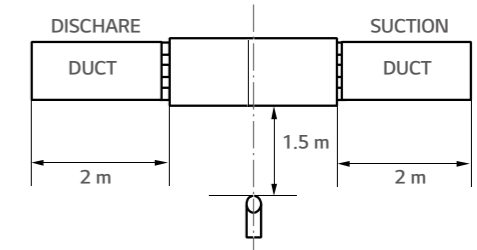

※ Measuring place : Anechoic chamber

Installation Space for Compressor Module

Top View

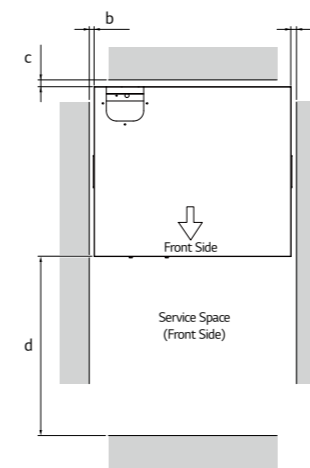

Front View

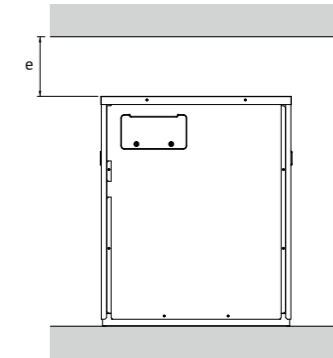

Category	Mark	Description	Installation Space (mm)
Compressor Module	a	Right	10 or More
	b	Left	10 or More
	c	Rear	10 or More
	d	Front	500 or More
	e	Top	200 or More

Installation Space for Compressor Module

Top View

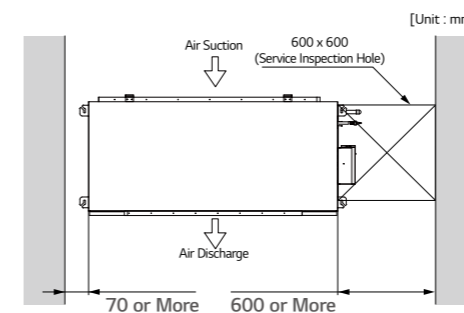

Front View

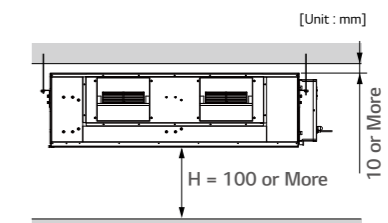

MULTI V M

ARUN050LMCO
ARUN050GME0



LG participates in the ECP programme for EUROVENT VRF program. Check ongoing validity of certification : www.eurovent-certification.com



System

	HP	5
Model Name	Set	ARUN050LMS0
	Compressor Module	ARUN050LMCO
	Heat Exchanger Module	ARUN050GME0
Capacity	Cooling (Rated) kW	14.0
	Heating (Rated) kW	14.0
	Heating (Max) kW	16.0
Input	Cooling (Rated) kW	4.12
	Heating (Rated) kW	3.59
	Heating (Max) kW	4.32
EER	Based on Rated Capacity	3.40
SEER		7.03
COP	Based on Rated Capacity	3.90
	Based on Max Capacity	3.70
SCOP		4.12
Number of Maximum Connectable Indoor Units		10

※ ○ : Applied, - : Not Applied
Note

- Due to our policy of innovation some specifications may be changed without notification.
- Wiring cable size must comply with the applicable local and national codes. And "Electric characteristics" chapter should be considered for electrical work and design. Especially the power cable and circuit breaker should be selected in accordance with that.
- Power factor could vary less than ±1% according to the operating conditions.
- Sound pressure level is measured on the rated condition in the anechoic rooms by ISO 3745 standard. Sound power level is measured on the rated condition in the reverberation rooms by ISO 3741 standard. Therefore, these values can be increased owing to ambient conditions during operation.
- Performances are based on the following conditions :
 - Cooling : Indoor Ambient Temp 27°CDB / 19°CWB, Outdoor Ambient Temp 35°CDB / 24°CWB
 - Heating : Indoor Ambient Temp 20°CDB / 15°CWB, Outdoor Ambient Temp 7°CDB / 6°CWB
 - Interconnected Pipe Length and Difference of Elevation : - Heat Exchanger Module - Compressor Module = 5m
 - Compressor Module - Indoor Unit = 7.5m
 - Difference of Elevation (Heat Exchanger Module- Compressor Moduler - Indoor Unit) is Zero
- The maximum combination ratio is 130%.
- This product contains Fluorinated greenhouse gases. (R410A, GWP(Global warming potential) = 2,087.5)

MULTI V M

ARUN050LMCO
ARUN050GME0



LG participates in the ECP programme for EUROVENT VRF program. Check ongoing validity of certification : www.eurovent-certification.com



Module

	HP	5
Model Names		Compressor Module ARUN050LMCO
		Heat Exchanger Module ARUN050GME0
Exterior	Color	Morning Gray
	RAL Code (Classic)	RAL 7030
Dimensions (W x H x D)	Net mm x No.	580 x 700 x 500
	Shipping mm x No.	618 x 833 x 564
Weight	Net kg x No.	69 x 1
	Shipping kg x No.	76 x 1
Compressor	Type	Hermetic Motor Compressor
	Combination x No.	(Inverter) x 1
	Motor Output W x No.	3,200
	Oil Type	FVC68D (PVE)
Heat Exchanger	Oil Charge cc	1,300
	Type	-
Fan	Type	Wide Louver Plus / Black Fin
	Motor Output x Number W x No.	-
	Air Flow Rate (Rated) m³/min x No.	400 x 2
External Static Pressure	Nominal (Rated, Factory Set) mmAq (Pa)	3 (29)
	Max mmAq (Pa)	16 (157)
Pipe Connection	Liquid mm (inch)	Ø9.52 (3/8) to IDU
	Gas mm (inch)	Ø15.88 (5/8) to IDU
	Drain mm (inch)	Ø19.05 (3/4) to Comp Module
Sound Pressure Level	Cooling (Rated) dB(A)	45.0
	Heating (Rated) dB(A)	45.0
Sound Power Level		45.0
Communication Cable		72.0
	mm² x No. (VCTF-SB)	1.0 - 1.5 x 2C to IDU
Refrigerant		1.0 - 1.5 x 2C to Comp Module
	Refrigerant Name	R410A
	Precharged Amount kg	R410A
	t-CO ₂ eq	2.0
Power Supply	Control	4.175
	Ø, V, Hz	-
		Electronic Expansion Valve
		1, 220-240, 50

※ ○ : Applied, - : Not Applied
Note

- Due to our policy of innovation some specifications may be changed without notification.
- Wiring cable size must comply with the applicable local and national codes. And "Electric characteristics" chapter should be considered for electrical work and design. Especially the power cable and circuit breaker should be selected in accordance with that.
- Power factor could vary less than ±1% according to the operating conditions.
- Sound pressure level is measured on the rated condition in the anechoic rooms by ISO 3745 standard. Sound power level is measured on the rated condition in the reverberation rooms by ISO 3741 standard. Therefore, these values can be increased owing to ambient conditions during operation.
- Performances are based on the following conditions :
 - Cooling : Indoor Ambient Temp 27°CDB / 19°CWB, Outdoor Ambient Temp 35°CDB / 24°CWB
 - Heating : Indoor Ambient Temp 20°CDB / 15°CWB, Outdoor Ambient Temp 7°CDB / 6°CWB
 - Interconnected Pipe Length and Difference of Elevation : - Heat Exchanger Module - Compressor Module = 5m
 - Compressor Module - Indoor Unit = 7.5m
 - Difference of Elevation (Heat Exchanger Module- Compressor Moduler - Indoor Unit) is Zero
- The maximum combination ratio is 130%.
- This product contains Fluorinated greenhouse gases. (R410A, GWP(Global warming potential) = 2,087.5)

MULTI V™ WATER IV

- Water Cooled VRF Heat Pump & Heat Recovery
- 22.4 ~ 201.6kW (Cooling capacity based)
- 3Ø, 380 ~ 415V, 50Hz
- Outdoor unit installed indoor

300M
TOTAL PIPING LENGTH

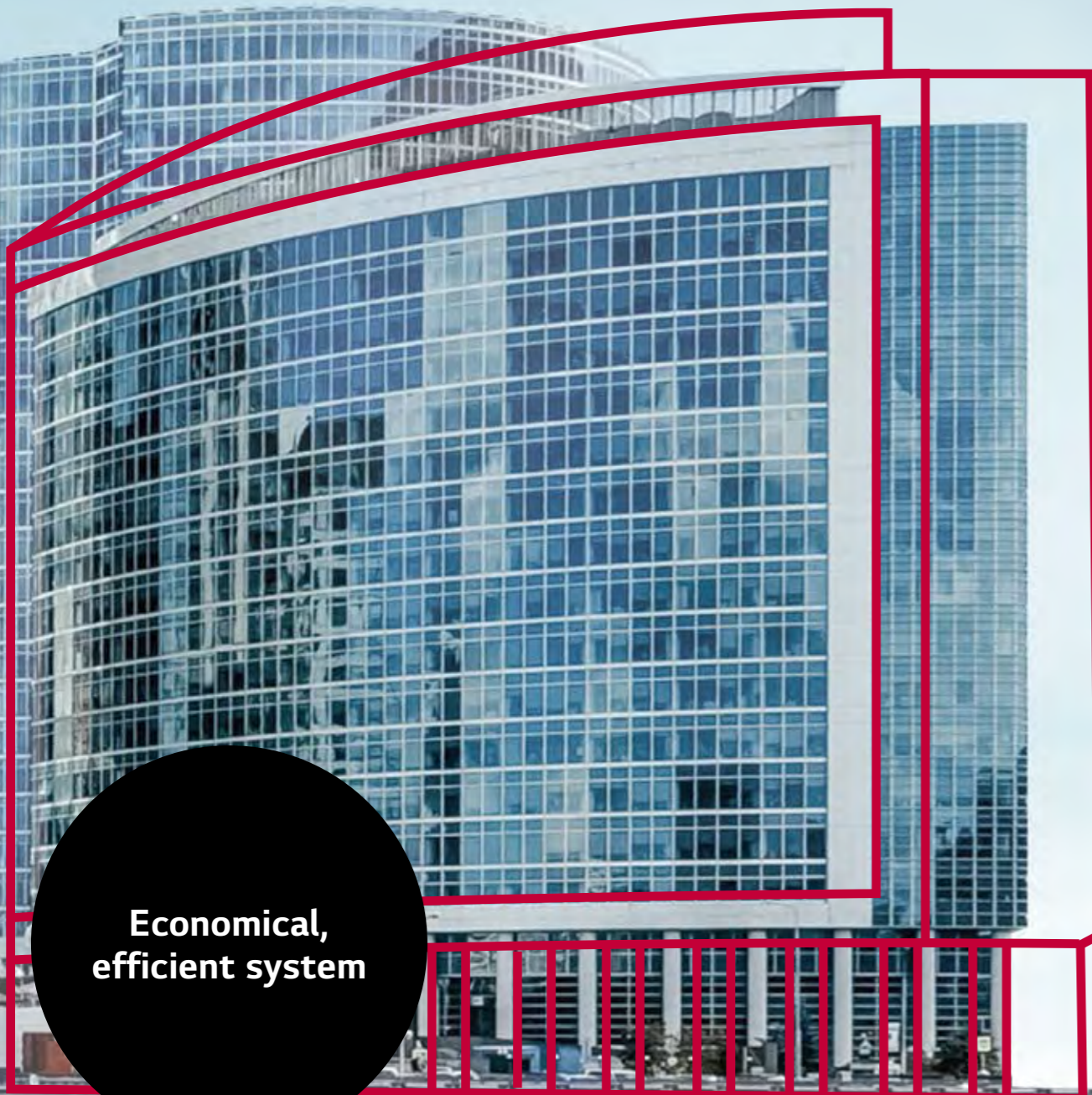

Economical,
efficient system

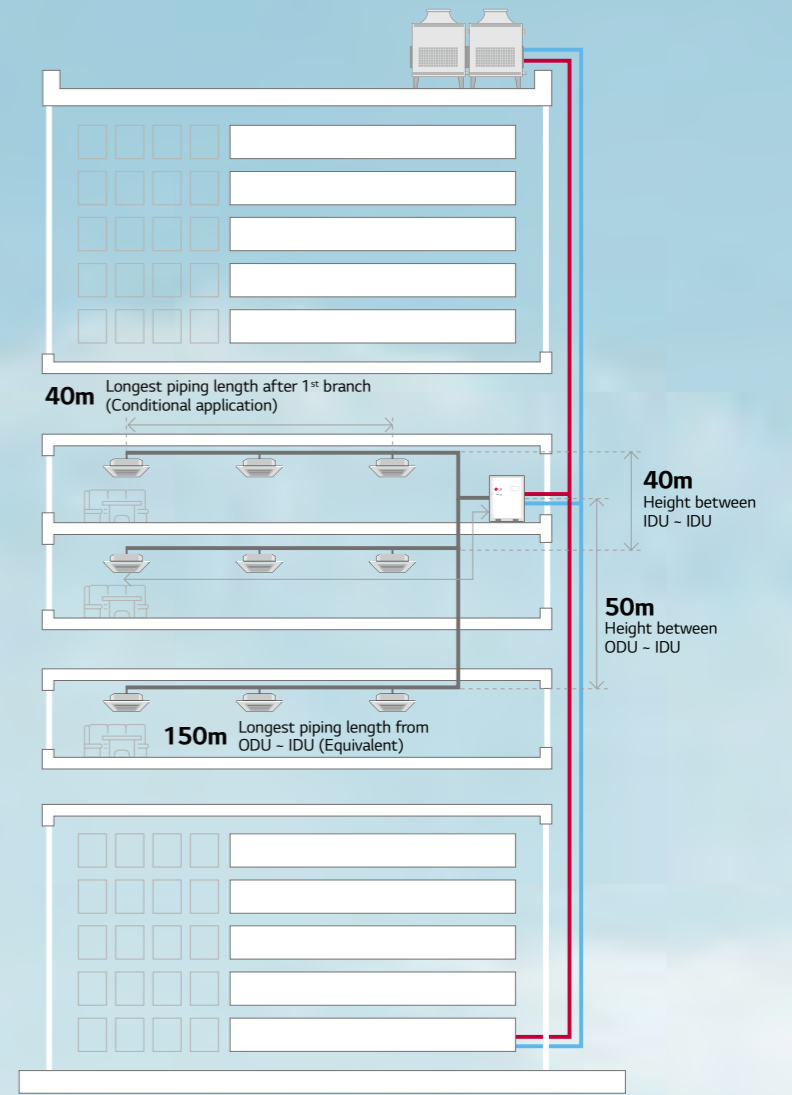

Energy savings



Space savings



Convenient installation

How does it work?

Operation independent of weather conditions



Available in Heat Pump & Heat Recovery Configuration

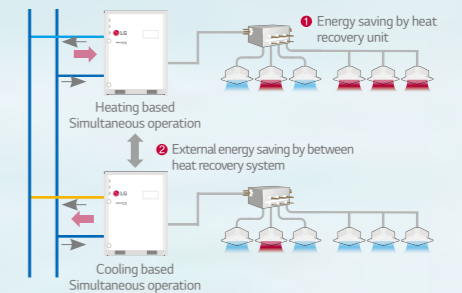

Geothermal Application

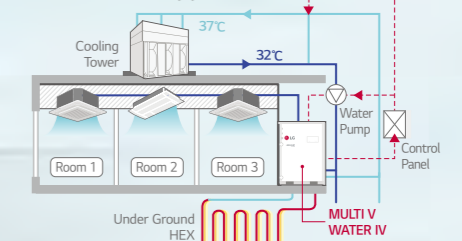

INNOVATIVE TECHNOLOGIES

High Efficiency System Regardless of External Conditions

Regardless of outdoor temperature and other environmental conditions, MULTI V WATER IV is the optimal solution.

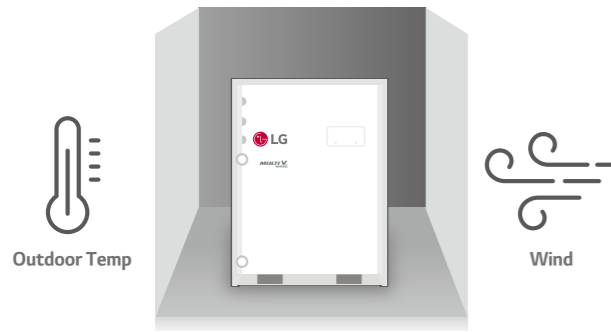

MULTI V WATER IV System for Geothermal Applications

Uses underground heat sources like soil, ground water, lakes, rivers and more as renewable energy for cooling and heating. Water or antifreeze solution is circulated through the closed loop HDPE (High Density Poly-Ethylene) pipes buried beneath the earth's surface.

- The Circulating water temperature range is between -5°C ~ 45°C
- Antifreeze should be applied depending on the application.

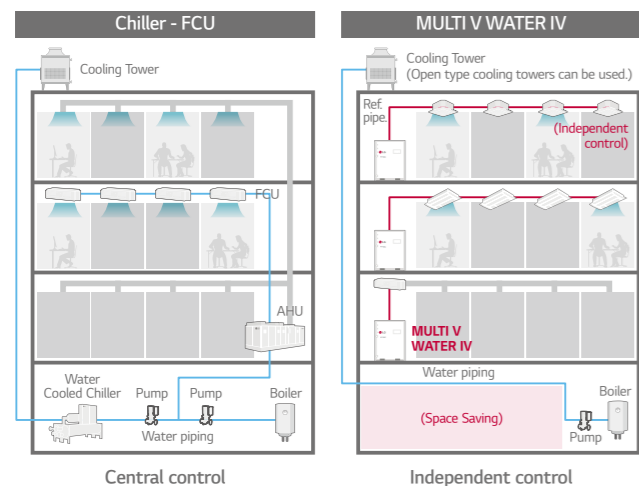
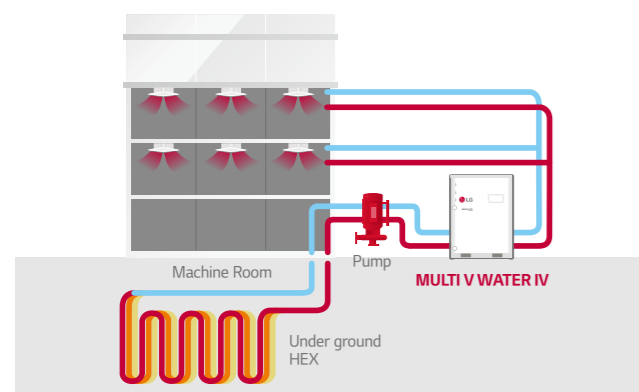

ENERGY SAVING

Economical, Highly Efficient System

LG's key technologies are integrated to inverter compressor

With 4th generation inverter compressor, the MULTI V WATER IV boasts top-class energy efficiency.

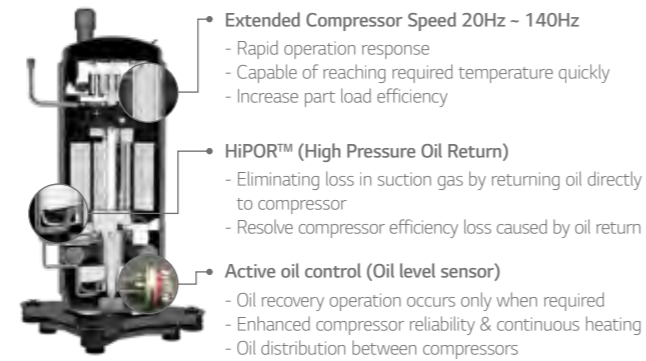

Maximum COP

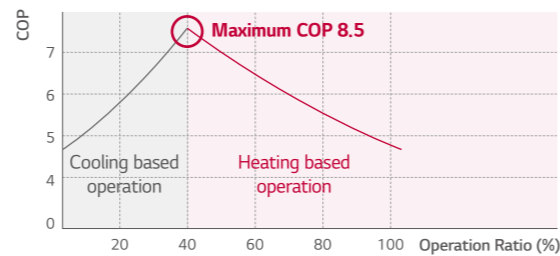

※ Outdoor unit water inlet temperature : 7°C
 ※ Indoor temperature : 20°C DB / 15°C WB
 ※ Maximum COP Condition : Cooling 40% + Heating 60% operation

Economical, Highly Efficient System

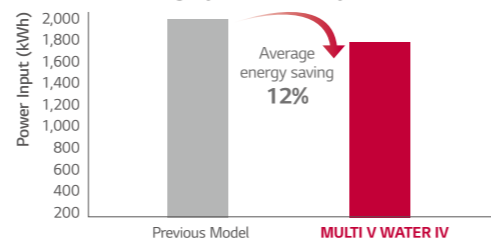

LG's 4th Generation Inverter Compressor

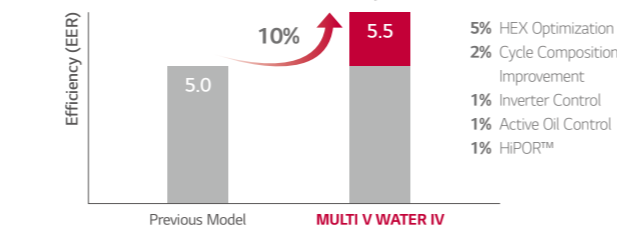

※ Comparison between 10HP (28kW) in cooling mode

Integrated Part Load Efficiency

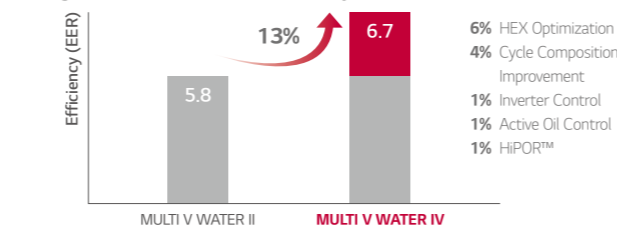

WATER SAVINGS

Variable Water Flow Control (Option)

In support of green building initiatives

The world's first variable water flow control system for water cooled VRF system. LG applied Variable Water Flow Control to optimize water flow control regarding partial cooling or heating load conditions. Because of this it's also possible to reduce circulation pump energy consumption.

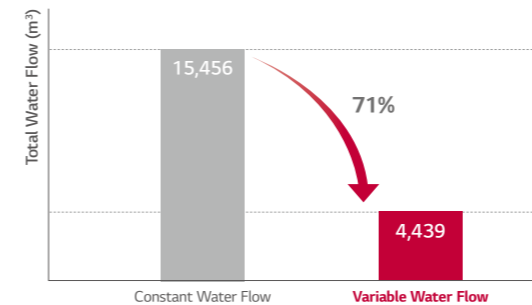
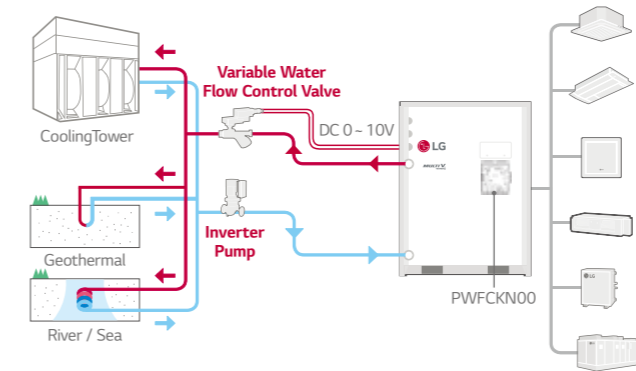

Note
 1. Location : Paris, France
 2. Office, 68,000m²
 3. Operation time : 1,344 hours (Cooling period)

Project Example : 63F (Pump : 20,064 LPM, 42.4mAq x 4ea)

- 1) Inverter pump with MULTI V WATER and variable water flow control kit
- 2) Constant pump (Step control) with Water cooled VRF

10 years energy cost (\$)

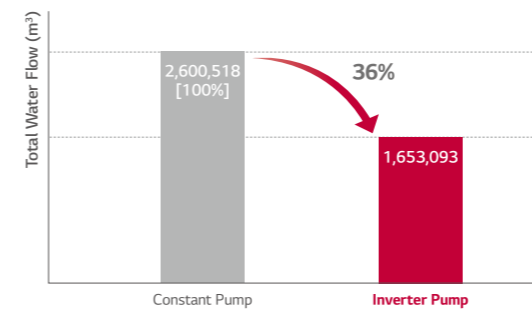

Unit	5 years		10 years	
	Energy Use (kWh)	Pump Running Cost (\$)	Energy Use (kWh)	Pump Running Cost (\$)
Constant pump	7,952,040	1,142,441	15,904,080	2,600,518
Inverter pump	5,054,940	726,225	10,109,880	1,653,093

- Power consumption rate : 0.13\$/kWh
- Annual power consumption rate expected to increase by 5%

FLEXIBLE DESIGN & SPACE SAVINGS

Largest Capacity

Sufficient pipe length limitation provides flexible design and installation

Providing 8 ~ 20HP (22.4 ~ 56kW) with single unit, and up to the world's largest capacity 80HP (224kW) by combination.

	8	10	14	20	22	24	28	30	34	40	42 ~ 60	62 ~ 80
HP	8	10	14	20	22	24	28	30	34	40	42 ~ 60	62 ~ 80
kW	22.4	28	39.2	56	61.6	67.2	78.4	84	95.2	112	117.6 ~ 168	173.6 ~ 224
LG	1 Unit		2 Units		3 Units		4 Units					

Longest Piping Length

Sufficient pipes length limitation in design and installation of immense variety of building

Provide flexible installation up to 300m of total piping length. As water pipes are not connected to indoor units, users are free from water leakage problems.

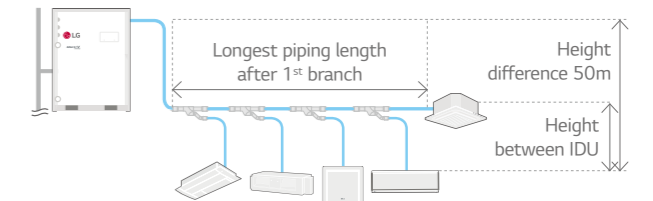

Total Piping Length	300m
Actual longest piping length (Equivalent)	150m (175m)
Longest piping length after 1 st branch (Conditional application)	40m (90m)
Height difference between ODU - IDU	50m
Height difference between IDU - IDU	40m

Compact Size

Thanks to compact size of product, it provides more space for commercial or public use as much as possible.

The optimal design of the compact, lightweight outdoor unit enables double stacking, which results in 50% savings in installation space.



※ 112kW, Floor area based

Lightweight

Nothing or Decrease additional load reinforcement work at building

Easier to transport and install thanks to 18% reduction in overall weight.

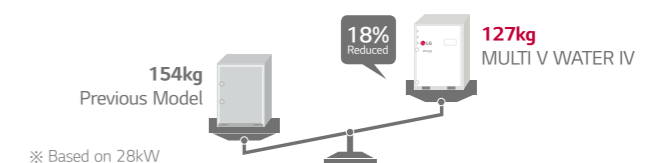

※ Based on 28kW

Nomenclature

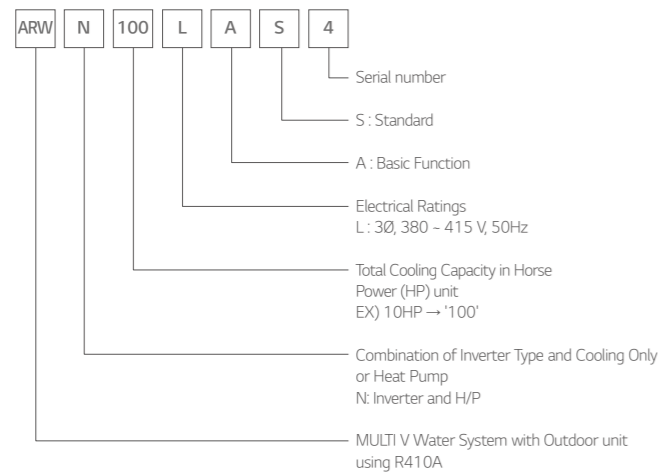

Outdoor Units Function

Category	Functions	MULTI V WATER IV
Key Refrigerant Components	Variable Path of Outdoor unit HEX	-
	HiPOR™ (High Pressure Oil Return)	○
	Humidity Sensor	-
	Corrosion Resistance Black Fin	-
	Oil Sensor	○
Useful Function	Dual Sensing	-
	Low Noise Operation	-
	High Static Mode of Outdoor Unit Fan	-
	Partial Defrosting	-
	Auto Dust Cleaning of Outdoor Unit (Fan reverse rotation)	-
Reliability	Indoor Cooling Comfort Mode Based Outdoor Temperature	-
	Smart Load Control (SLC) (Changing indoor discharge air temperature according to load)	-
	Outdoor Unit Control Refer to Humidity	-
	Defrost / Deicing	-
	High Pressure Switch	○
Central Controller	Phase Protection	○
	Restart Delay (3-minutes)	○
	Self Diagnosis	○
	Soft Start	○
	Test Run Function	○
BNU (Building Network Unit)	AC Ez (Simple Controller)	PQCSZ250S0
	AC Ez Touch	PACEZA000
	AC Smart IV	PACS4B000
	AC Smart 5	PAC5A000
	ACP (Advanced Control Platform) IV	PQPC22A0
Installation	ACP (Advanced Control Platform) 5	PACP5A000
	AC Manager 5	PACM5A000
	ACP Lonworks	PLNWKB000
	ACP BACnet	PQNF17C0
	Refrigerant Charging Kit	-
PDI (Power Distribution Indicator)	Variable Water Flow Valve Control Kit	PWFCKN000
	Standard	PPWRDB000
Cool / Heat Selector	Premium	PQNUD1S40
	PRDSBM	-
IO Module (ODU Dry Contact)	Low Ambient Kit	-
	PVDSMN000	-
Cycle Monitoring Device	LGMV	PRCTI00
	Mobile LGMV	PLGMVW100

※ ○ : Applied, - : Not Applied

Operation Limits

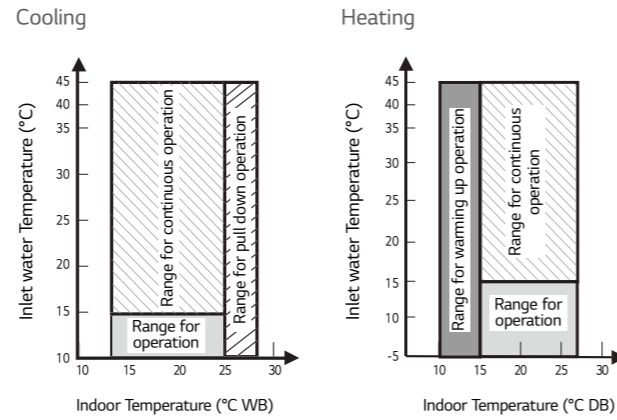

Note
 1. These figures assume the following operating conditions:
 2. Equivalent piping length : 7.5m
 3. Level difference : 0m

Position of Sound Pressure Level Measuring

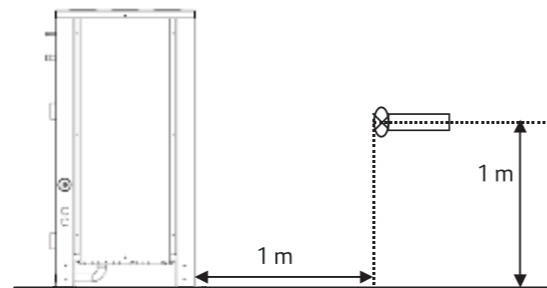

Note
 1. Data is valid at free field condition
 2. Data is valid at nominal operating condition
 3. Sound level will vary depending on a range of factors such as the construction (Acoustic absorption coefficient) of particular room in which the equipment is installed
 4. Sound level can be increased in static pressure mode or air guide application.

Optional Accessories

No.	Name	Model
1	Y branch pipe	ARBLN01621
		ARBLN03321
		ARBLN07121
		ARBLN14521
		ARBLN23220
2	Header	ARBL054
		ARBL057
		ARBL104
		ARBL107
		ARBL1010
3	Connection pipe of Outdoor Units	ARCNN21
		ARCNN31
		ARCNN41

MULTI V WATER IV Heating Dissipation Value by Model

Model	HP	Heating Dissipation Value	
ARWN080LAS4	8	600 W	515.9 kcal/h 0.143 kcal/s
ARWN100LAS4	10	630 W	541.7 kcal/h 0.150 kcal/s
ARWN120LAS4	12	660 W	567.5 kcal/h 0.158 kcal/s
ARWN140LAS4	14	690 W	593.3 kcal/h 0.165 kcal/s
ARWN160LAS4	16	700 W	601.9 kcal/h 0.167 kcal/s
ARWN180LAS4	18	720 W	619.1 kcal/h 0.172 kcal/s
ARWN200LAS4	20	750 W	644.9 kcal/h 0.179 kcal/s

Test condition : Indoor air temperature : DB 40°C, WB : 32°C
 ※ A design stage should be considered to ventilation system in mechanical room.

ARWN080LAS4 / ARWN100LAS4 / ARWN140LAS4 / ARWN200LAS4

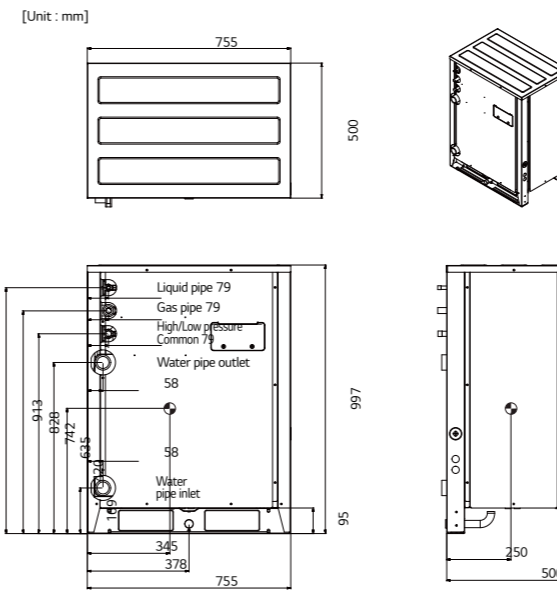

Individual Installation

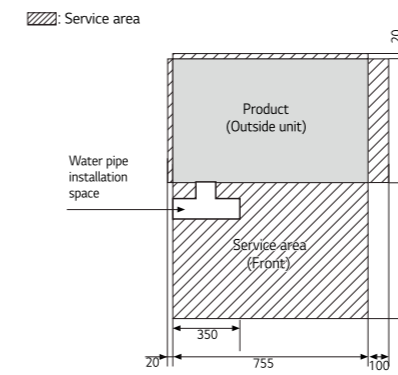

Water Piping Installation

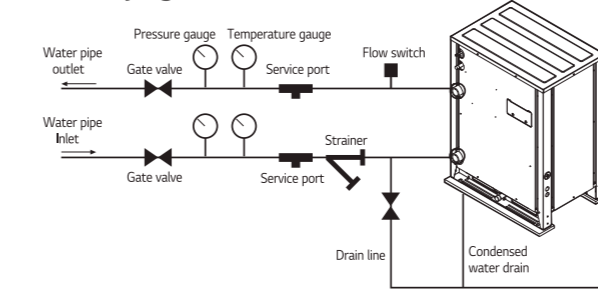

Precaution of Installation

- Do not install the unit at the outdoors. (Installation of the unit outdoors could result in fire or electric shock.) Recommended ambient temperature of outdoor unit is between 0 ~ 40°C.
- Keep the water temperature between **10 ~ 45°C**. Standard water supply temperature is 30°C for cooling and 20°C for heating.
- Establish an **anti-freeze plan** for the water supply when the product is stopped during the winter.
- Be careful of the **water purity control**. Ensure water purity control to avoid breakdown due to water pipe corrosion. Refer to 'Standard Table for Water Purity Control' in PDB (Product Data Book).
- The water pressure resistance of the water pipe system of this product is **1.98MPa**.
- Always install a **trap** so that the drained water does not back flush.
- Install a **pressure gauge and temperature gauge** at the inlet and outlet of the water pipe.
- Flexible joints** must be installed not to cause any leakage from the vibration of pipes.
- Install a **service port** to clean the heat exchanger at the each end of the water inlet and outlet.
- It is recommended to install the **flow switch** to the water collection pipe system connecting to the outdoor unit. (Flow switch acts as the 1st protection device when the heat water is not supplied.)
- When setting the flow switch, it is recommended to use the product with default set value to satisfy the minimum flow rate of this product. (The minimum flow rate range of this product is **50%**.)
- To protect the water cooling type product, you must install a **strainer with 50 mesh** or more on the heat water supply pipe. If not installed, it can result in damage of heat exchanger by the following situation.
 - Heat water supply within the plate type heat exchanger is composed of multiple small paths.
 - If you do not use a strainer with 50 mesh or more, alien particles can partially block the water paths.
 - When running the heater, the plate type heat exchanger plays the role of the evaporator, and at this time, the temperature of the refrigerant side drops to drop the temperature of the heat water supply, which can result in icing point in the water paths.
 - As the heating process progresses, the water paths can be partially frozen to lead to damage in plate type heat exchanger.
 - As a result of the damage of the heat exchanger from the freezing, the refrigerant side and the heat water source side will be mixed to make the product unusable.

REFERENCE SITE

Bouygues Challenger

LG MULTI V WATER Solution with Geothermal Application



Site Information

The industrial group Bouygues was established in France in 1952. It now maintains operations in 80 countries and employs more than 131,000 people. In 1988, after two years of construction, the new headquarters for Bouygues Construction was officially opened for business. Named Challenger, the complex became a technological showcase for late 20th century architecture.

LG Solution

Bouygues decided to convert their headquarters into an eco-friendly building by significantly reducing its energy footprint. The LG MULTI V Water system was chosen as the ideal HVAC solution for this project. The system not only saves energy but also reduces water usage as it recycles water in order to regulate the temperature of the building. With LG's advanced technology, the building's water consumption was reduced by more than 70 percent.

MULTI V WATER IV HEAT PUMP

ARWN080LAS4 / ARWN100LAS4
ARWN140LAS4



HP		8	10	14
Model Name	Combination Unit	ARWN080LAS4	ARWN100LAS4	ARWN140LAS4
	Independent Unit	ARWN080LAS4	ARWN100LAS4	ARWN140LAS4
Capacity	Cooling (Rated) kW	22.4	28.0	39.2
	Heating (Rated) kW	25.2	31.5	44.1
Input	Cooling (Rated) kW	3.86	5.09	7.84
	Heating (Rated) kW	4.2	5.34	8.17
EER		5.80	5.50	5.00
COP	Rated Capacity	6.00	5.90	5.40
Exterior	Color	Warm Gray / Morning Gray	Warm Gray / Morning Gray	Warm Gray / Morning Gray
	RAL Code (Classic)	RAL 7044 / RAL 7030	RAL 7044 / RAL 7030	RAL 7044 / RAL 7030
Heat Exchanger	Type	Stainless Steel Plate	Stainless Steel Plate	Stainless Steel Plate
	Maximum Pressure Resistance	kgf/cm ²	45	45
	Head Loss	kPa	10.7	15.8
	Rated Water Flow	LPM	77	96
Compressor	Type	Hermetically Sealed Scroll	Hermetically Sealed Scroll	Hermetically Sealed Scroll
	Combination x No.	(Inverter) x 1	(Inverter) x 1	(Inverter) x 1
	Motor Output x Number	W x No.	4,200 x 1	4,200 x 1
	Oil Type	FVC68D (PVE)	FVC68D (PVE)	FVC68D (PVE)
Refrigerant Connecting Pipes	Liquid Pipe	mm (inch)	Ø9.52 (3/8)	Ø12.7 (1/2)
	Gas Pipe	mm (inch)	Ø22.2 (7/8)	Ø25.4 (1)
Water Connecting Pipes	Inlet	A (inch)	40A(PT 1-1/2) (Internal Thread)	40A(PT 1-1/2) (Internal Thread)
	Outlet	A (inch)	40A(PT 1-1/2) (Internal Thread)	40A(PT 1-1/2) (Internal Thread)
	Drain Outlet	A (inch)	20A(PT 3/4) (External Thread)	20A(PT 3/4) (External Thread)
Dimensions (W x H x D)	mm x No.	(755 x 997 x 500) x 1	(755 x 997 x 500) x 1	(755 x 997 x 500) x 1
Dimensions (W x H x D) - Shipping	mm x No.	(804 x 1,143 x 630) x 1	(804 x 1,143 x 630) x 1	(804 x 1,143 x 630) x 1
Net Weight	kg x No.	127 x 1	127 x 1	127 x 1
Shipping Weight	kg x No.	137 x 1	137 x 1	137 x 1
Sound Pressure Level	Cooling	dB(A)	47.0	50.0
	Heating	dB(A)	51.0	53.0
Sound Power Level	Cooling	dB(A)	59.0	62.0
	Heating	dB(A)	63.0	65.0
Communication Cable	mm ² x No. (VCTF-SB)	1.0 - 1.5 x 2C	1.0 - 1.5 x 2C	1.0 - 1.5 x 2C
Refrigerant	Refrigerant Name		R410A	R410A
	Precharged Amount in Factory	kg	5.8	5.8
	t-CO ₂ eq		12.1	12.1
	Control		Electronic Expansion Valve	Electronic Expansion Valve
Power Supply	Ø, V, Hz	3, 380-415, 50	3, 380-415, 50	3, 380-415, 50
Number of Maximum Connectable Indoor Units		13 (20)	16 (25)	23 (35)

Note
 1. Maximum numbers are prepared based on assumption that all 2.2kW indoor units are connected. The numbers in parentheses means maximum connectable indoor units in accordance with outdoor units combination (160% - 200%). The recommended ratio is 130%.
 2. Due to our policy of innovation some specifications may be changed without notification
 3. Performances are based on the following conditions
 - Cooling : Indoor temp 27°C (80.6°F) DB / 19°C (66.2°F) WB, Water inlet temp 30°C (86°F)
 - Heating : Indoor temp 20°C (68°F) DB, Water inlet temp 20°C (68°F)
 - Interconnected Pipe Length is 7.5m and difference of Elevation (Outdoor - Indoor Unit) is 0m.
 4. Sound pressure level is measured on the rated condition in the anechoic rooms by ISO 3745 standard. Sound power level is measured on the rated condition in the reverberation rooms by ISO 3741 standard. Therefore, these values can be increased owing to ambient conditions during operation.
 5. This product contains Fluorinated Greenhouse Gases. (R410A)
 6. Add an anti freeze to circulation water when outdoor unit is operating under 10°C (50°F), and change the DIP switch on main PCB. (For more information on installation section.)

MULTI V WATER IV HEAT PUMP

ARWN200LAS4 / ARWN160LAS4
ARWN180LAS4



HP		20	16	18	
Model Name	Combination Unit	ARWN200LAS4	ARWN160LAS4	ARWN180LAS4	
	Independent Unit	ARWN200LAS4	ARWN080LAS4 ARWN080LAS4	ARWN100LAS4 ARWN080LAS4	
Capacity	Cooling (Rated) kW	56.0	44.8	50.4	
	Heating (Rated) kW	63.0	50.4	56.7	
Input	Cooling (Rated) kW	11.20	7.72	8.95	
	Heating (Rated) kW	11.67	8.40	9.54	
EER		5.00	5.80	5.63	
COP	Rated Capacity	5.40	6.00	5.94	
Exterior	Color	Warm Gray / Morning Gray	Warm Gray / Morning Gray	Warm Gray / Morning Gray	
	RAL Code (Classic)	RAL 7044 / RAL 7030	RAL 7044 / RAL 7030	RAL 7044 / RAL 7030	
Heat Exchanger	Type	Stainless Steel Plate	Stainless Steel Plate	Stainless Steel Plate	
	Maximum Pressure Resistance	kgf/cm ²	45	45	
	Head Loss	kPa	30.1	10.7 + 10.7	15.8 + 10.7
	Rated Water Flow	LPM	192	77 + 77	96 + 77
	Type		Hermetically Sealed Scroll	Hermetically Sealed Scroll	Hermetically Sealed Scroll
Compressor	Combination x No.	(Inverter) x 1	(Inverter) x 2	(Inverter) x 2	
	Motor Output x Number	W x No.	5,300 x 1	4,200 x 2	4,200 x 2
	Oil Type		FVC68D (PVE)	FVC68D (PVE)	FVC68D (PVE)
	Oil Charge	cc	3,000	5,600	5,600
Refrigerant Connecting Pipes	Liquid Pipe	mm (inch)	Ø12.7 (1/2)	Ø12.7 (1/2)	Ø12.7 (1/2)
	Gas Pipe	mm (inch)	Ø28.58 (1-1/8)	Ø28.58 (1-1/8)	Ø28.58 (1-1/8)
Water Connecting Pipes	Inlet	A (inch)	40A (PT 1-1/2) (Internal Thread)	40A (PT 1-1/2) + 40A (PT 1-1/2) (Internal Thread)	40A (PT 1-1/2) + 40A (PT 1-1/2) (Internal Thread)
	Outlet	A (inch)	40A (PT 1-1/2) (Internal Thread)	40A (PT 1-1/2) + 40A (PT 1-1/2) (Internal Thread)	40A (PT 1-1/2) + 40A (PT 1-1/2) (Internal Thread)
	Drain Outlet	A (inch)	20A (PT 3/4) (External Thread)	20A (PT 3/4) (External Thread)	20A (PT 3/4) (External Thread)
Dimensions (W x H x D)	mm x No.	(755 x 997 x 500) x 1	(755 x 997 x 500) x 2	(755 x 997 x 500) x 2	
Dimensions (W x H x D) - Shipping	mm x No.	(804 x 1,143 x 630) x 1	(804 x 1,143 x 630) x 2	(804 x 1,143 x 630) x 2	
Net Weight	kg x No.	140 x 1	127 x 2	127 x 2	
Shipping Weight	kg x No.	150 x 1	137 x 2	137 x 2	
Sound Pressure Level	Cooling	dB(A)	54.0	50.0	51.8
	Heating	dB(A)	60.0	54.0	55.1
Sound Power Level	Cooling	dB(A)	66.0	62.0	63.8
	Heating	dB(A)	72.0	66.0	67.1
Communication Cable	mm ² x No. (VCTF-SB)		1.0 - 1.5 x 2C	1.0 - 1.5 x 2C	1.0 - 1.5 x 2C
Refrigerant	Refrigerant Name		R410A	R410A	R410A
	Precharged Amount in Factory	kg	3.0	11.6	11.6
	t-CO ₂ eq		6.3	24.2	24.2
	Control		Electronic Expansion Valve	Electronic Expansion Valve	Electronic Expansion Valve
Power Supply	Ø, V, Hz		3, 380-415, 50	3, 380-415, 50	3, 380-415, 50
Number of Maximum Connectable Indoor Units			32 (50)	26 (40)	29 (45)

- Note
- Maximum numbers are prepared based on assumption that all 2.2kW indoor units are connected. The numbers in parentheses means maximum connectable indoor units in accordance with outdoor units combination (160% - 200%). The recommended ratio is 130%.
 - Due to our policy of innovation some specifications may be changed without notification
 - Performances are based on the following conditions
 - Cooling : Indoor temp 27°C (80.6°F) DB / 19°C (66.2°F) WB, Water inlet temp 30°C (86°F)
 - Heating : Indoor temp 20°C (68°F) DB, Water inlet temp 20°C (68°F)
 - Interconnected Pipe Length is 7.5m and difference of Elevation (Outdoor - Indoor Unit) is 0m.
 - Sound pressure level is measured on the rated condition in the anechoic rooms by ISO 3745 standard. Sound power level is measured on the rated condition in the reverberation rooms by ISO 3741 standard. Therefore, these values can be increased owing to ambient conditions during operation.
 - This product contains Fluorinated Greenhouse Gases. (R410A)
 - Add an anti freeze to circulation water when outdoor unit is operating under 10°C (50°F), and change the DIP switch on main PCB. (For more information on installation section.)

MULTI V WATER IV HEAT PUMP

ARWN220LAS4 / ARWN240LAS4
ARWN280LAS4



HP		22	24	28	
Model Name	Combination Unit	ARWN220LAS4	ARWN240LAS4	ARWN280LAS4	
	Independent Unit	ARWN140LAS4 ARWN080LAS4	ARWN140LAS4 ARWN100LAS4	ARWN140LAS4 ARWN140LAS4	
Capacity	Cooling (Rated) kW	61.6	67.2	78.4	
	Heating (Rated) kW	69.3	75.6	88.2	
Input	Cooling (Rated) kW	11.70	12.93	15.68	
	Heating (Rated) kW	12.37	13.51	16.34	
EER		5.26	5.20	5.00	
COP	Rated Capacity	5.60	5.60	5.40	
Exterior	Color	Warm Gray / Morning Gray	Warm Gray / Morning Gray	Warm Gray / Morning Gray	
	RAL Code (Classic)	RAL 7044 / RAL 7030	RAL 7044 / RAL 7030	RAL 7044 / RAL 7030	
Heat Exchanger	Type	Stainless Steel Plate	Stainless Steel Plate	Stainless Steel Plate	
	Maximum Pressure Resistance	kgf/cm ²	45	45	
	Head Loss	kPa	28.6 + 10.7	28.6 + 15.8	28.6 + 28.6
	Rated Water Flow	LPM	135 + 77	135 + 96	135 + 135
	Type		Hermetically Sealed Scroll	Hermetically Sealed Scroll	Hermetically Sealed Scroll
Compressor	Combination x No.	(Inverter) x 2	(Inverter) x 2	(Inverter) x 2	
	Motor Output x Number	W x No.	4,200 x 2	4,200 x 2	4,200 x 2
	Oil Type		FVC68D (PVE)	FVC68D (PVE)	FVC68D (PVE)
	Oil Charge	cc	5,600	5,600	5,600
Refrigerant Connecting Pipes	Liquid Pipe	mm (inch)	Ø19.05 (3/4)	Ø19.05 (3/4)	Ø19.05 (3/4)
	Gas Pipe	mm (inch)	Ø34.9 (1-3/8)	Ø34.9 (1-3/8)	Ø34.9 (1-3/8)
Water Connecting Pipes	Inlet	A (inch)	40A (PT 1-1/2) + 40A (PT 1-1/2) (Internal Thread)	40A (PT 1-1/2) + 40A (PT 1-1/2) (Internal Thread)	40A (PT 1-1/2) + 40A (PT 1-1/2) (Internal Thread)
	Outlet	A (inch)	40A (PT 1-1/2) + 40A (PT 1-1/2) (Internal Thread)	40A (PT 1-1/2) + 40A (PT 1-1/2) (Internal Thread)	40A (PT 1-1/2) + 40A (PT 1-1/2) (Internal Thread)
	Drain Outlet	A (inch)	20A (PT 3/4) (External Thread)	20A (PT 3/4) (External Thread)	20A (PT 3/4) (External Thread)
Dimensions (W x H x D)	mm x No.	(755 x 997 x 500) x 2	(755 x 997 x 500) x 2	(755 x 997 x 500) x 2	
Dimensions (W x H x D) - Shipping	mm x No.	(804 x 1,143 x 630) x 2	(804 x 1,143 x 630) x 2	(804 x 1,143 x 630) x 2	
Net Weight	kg x No.	127 x 2	127 x 2	127 x 2	
Shipping Weight	kg x No.	137 x 2	137 x 2	137 x 2	
Sound Pressure Level	Cooling	dB(A)	58.3	58.6	59.0
	Heating	dB(A)	58.0	58.5	58.0
Sound Power Level	Cooling	dB(A)	70.3	70.6	72.0
	Heating	dB(A)	70.0	70.5	71.0
Communication Cable	mm ² x No. (VCTF-SB)		1.0 - 1.5 x 2C	1.0 - 1.5 x 2C	1.0 - 1.5 x 2C
Refrigerant	Refrigerant Name		R410A	R410A	R410A
	Precharged Amount in Factory	kg	11.6	11.6	11.6
	t-CO ₂ eq		24.2	24.2	24.2
	Control		Electronic Expansion Valve	Electronic Expansion Valve	Electronic Expansion Valve
Power Supply	Ø, V, Hz		3, 380-415, 50	3, 380-415, 50	3, 380-415, 50
Number of Maximum Connectable Indoor Units			35 (44)	39 (48)	45 (56)

- Note
- Maximum numbers are prepared based on assumption that all 2.2kW indoor units are connected. The numbers in parentheses means maximum connectable indoor units in accordance with outdoor units combination (160% - 200%). The recommended ratio is 130%.
 - Due to our policy of innovation some specifications may be changed without notification
 - Performances are based on the following conditions
 - Cooling : Indoor temp 27°C (80.6°F) DB / 19°C (66.2°F) WB, Water inlet temp 30°C (86°F)
 - Heating : Indoor temp 20°C (68°F) DB, Water inlet temp 20°C (68°F)
 - Interconnected Pipe Length is 7.5m and difference of Elevation (Outdoor - Indoor Unit) is 0m.
 - Sound pressure level is measured on the rated condition in the anechoic rooms by ISO 3745 standard. Sound power level is measured on the rated condition in the reverberation rooms by ISO 3741 standard. Therefore, these values can be increased owing to ambient conditions during operation.
 - This product contains Fluorinated Greenhouse Gases. (R410A)
 - Add an anti freeze to circulation water when outdoor unit is operating under 10°C (50°F), and change the DIP switch on main PCB. (For more information on installation section.)

MULTI V WATER IV HEAT PUMP

ARWN300LAS4 / ARWN340LAS4
ARWN400LAS4



HP		30	34	40	
Model Name	Combination Unit	ARWN300LAS4	ARWN340LAS4	ARWN400LAS4	
	Independent Unit	ARWN200LAS4 ARWN100LAS4	ARWN200LAS4 ARWN140LAS4	ARWN200LAS4 ARWN140LAS4	
Capacity	Cooling (Rated) kW	84.0	95.2	112.0	
	Heating (Rated) kW	94.5	107.1	126.0	
Input	Cooling (Rated) kW	16.29	19.04	22.40	
	Heating (Rated) kW	17.01	19.84	23.34	
EER		5.16	5.00	5.00	
COP	Rated Capacity	5.56	5.40	5.40	
Exterior	Color	Warm Gray / Morning Gray	Warm Gray / Morning Gray	Warm Gray / Morning Gray	
	RAL Code (Classic)	RAL 7044 / RAL 7030	RAL 7044 / RAL 7030	RAL 7044 / RAL 7030	
Heat Exchanger	Type	Stainless Steel Plate	Stainless Steel Plate	Stainless Steel Plate	
	Maximum Pressure Resistance	kgf/cm ²	45	45	
	Head Loss	kPa	30.1 + 15.8	30.1 + 28.6	30.1 + 30.1
	Rated Water Flow	LPM	192 + 96	192 + 135	192 + 192
	Type		Hermetically Sealed Scroll	Hermetically Sealed Scroll	Hermetically Sealed Scroll
Compressor	Combination x No.	(Inverter) x 2	(Inverter) x 2	(Inverter) x 2	
	Motor Output x Number	W x No.	5,300 x 1 + 4,200 x 1	5,300 x 1 + 4,200 x 1	5,300 x 2
	Oil Type		FVC68D (PVE)	FVC68D (PVE)	FVC68D (PVE)
	Oil Charge	cc	5,800	5,800	6,000
Refrigerant Connecting Pipes	Liquid Pipe	mm (inch)	Ø19.05 (3/4)	Ø19.05 (3/4)	Ø19.05 (3/4)
	Gas Pipe	mm (inch)	Ø34.9 (1-3/8)	Ø34.9 (1-3/8)	Ø41.3 (1-5/8)
Water Connecting Pipes	Inlet	A (inch)	40A (PT 1-1/2) + 40A (PT 1-1/2) (Internal Thread)	40A (PT 1-1/2) + 40A (PT 1-1/2) (Internal Thread)	40A (PT 1-1/2) + 40A (PT 1-1/2) (Internal Thread)
	Outlet	A (inch)	40A (PT 1-1/2) + 40A (PT 1-1/2) (Internal Thread)	40A (PT 1-1/2) + 40A (PT 1-1/2) (Internal Thread)	40A (PT 1-1/2) + 40A (PT 1-1/2) (Internal Thread)
	Drain Outlet	A (inch)	20A (PT 3/4) (External Thread)	20A (PT 3/4) (External Thread)	20A (PT 3/4) (External Thread)
Dimensions (W x H x D)	mm x No.	(755 x 997 x 500) x 2	(755 x 997 x 500) x 2	(755 x 997 x 500) x 2	
Dimensions (W x H x D) - Shipping	mm x No.	(804 x 1,143 x 630) x 2	(804 x 1,143 x 630) x 2	(804 x 1,143 x 630) x 2	
Net Weight	kg x No.	(140 x 1) + (127 x 1)	(140 x 1) + (127 x 1)	140 x 2	
Shipping Weight	kg x No.	(150 x 1) + (137 x 1)	(150 x 1) + (137 x 1)	150 x 2	
Sound Pressure Level	Cooling	dB(A)	55.5	59.0	55.0
	Heating	dB(A)	60.8	61.0	61.0
Sound Power Level	Cooling	dB(A)	67.5	72.0	68.0
	Heating	dB(A)	72.8	74.0	74.0
Communication Cable	mm ² x No. (VCTF-SB)	1.0 - 1.5 x 2C	1.0 - 1.5 x 2C	1.0 - 1.5 x 2C	
Refrigerant	Refrigerant Name		R410A	R410A	R410A
	Precharged Amount in Factory	kg	8.8	8.8	6.0
	t-CO ₂ eq		18.4	18.4	12.5
	Control		Electronic Expansion Valve	Electronic Expansion Valve	Electronic Expansion Valve
Power Supply	Ø, V, Hz	3, 380-415, 50	3, 380-415, 50	3, 380-415, 50	
Number of Maximum Connectable Indoor Units		49 (60)	55 (64)	64	

- Note
- Maximum numbers are prepared based on assumption that all 2.2kW indoor units are connected. The numbers in parentheses means maximum connectable indoor units in accordance with outdoor units combination (160% - 200%). The recommended ratio is 130%.
 - Due to our policy of innovation some specifications may be changed without notification
 - Performances are based on the following conditions
 - Cooling : Indoor temp 27°C (80.6°F) DB / 19°C (66.2°F) WB, Water inlet temp 30°C (86°F)
 - Heating : Indoor temp 20°C (68°F) DB, Water inlet temp 20°C (68°F)
 - Interconnected Pipe Length is 7.5m and difference of Elevation (Outdoor - Indoor Unit) is 0m.
 - Sound pressure level is measured on the rated condition in the anechoic rooms by ISO 3745 standard. Sound power level is measured on the rated condition in the reverberation rooms by ISO 3741 standard. Therefore, these values can be increased owing to ambient conditions during operation.
 - This product contains Fluorinated Greenhouse Gases. (R410A)
 - Add an anti freeze to circulation water when outdoor unit is operating under 10°C (50°F), and change the DIP switch on main PCB. (For more information on installation section.)

MULTI V WATER IV HEAT PUMP

ARWN420LAS4 / ARWN440LAS4
ARWN480LAS4



HP		42	44	48	
Model Name	Combination Unit	ARWN420LAS4	ARWN440LAS4	ARWN480LAS4	
	Independent Unit	ARWN200LAS4 ARWN140LAS4 ARWN080LAS4	ARWN200LAS4 ARWN140LAS4 ARWN100LAS4	ARWN200LAS4 ARWN140LAS4 ARWN140LAS4	
Capacity	Cooling (Rated) kW	117.6	123.2	134.4	
	Heating (Rated) kW	132.3	138.6	151.2	
Input	Cooling (Rated) kW	22.9	24.13	26.88	
	Heating (Rated) kW	24.04	25.18	28.01	
EER		5.14	5.11	5.00	
COP	Rated Capacity	5.50	5.50	5.40	
Exterior	Color	Warm Gray / Morning Gray	Warm Gray / Morning Gray	Warm Gray / Morning Gray	
	RAL Code (Classic)	RAL 7044 / RAL 7030	RAL 7044 / RAL 7030	RAL 7044 / RAL 7030	
Heat Exchanger	Type	Stainless Steel Plate	Stainless Steel Plate	Stainless Steel Plate	
	Maximum Pressure Resistance	kgf/cm ²	45	45	
	Head Loss	kPa	30.1 + 28.6 + 10.7	30.1 + 28.6 + 15.8	30.1 + 28.6 + 28.6
	Rated Water Flow	LPM	192 + 135 + 77	192 + 135 + 96	192 + 135 + 135
	Type		Hermetically Sealed Scroll	Hermetically Sealed Scroll	Hermetically Sealed Scroll
Compressor	Combination x No.	(Inverter) x 3	(Inverter) x 3	(Inverter) x 3	
	Motor Output x Number	W x No.	5,300 x 1 + 4,200 x 2	5,300 x 1 + 4,200 x 2	5,300 x 1 + 4,200 x 2
	Oil Type		FVC68D (PVE)	FVC68D (PVE)	FVC68D (PVE)
	Oil Charge	cc	8,600	8,600	8,600
Refrigerant Connecting Pipes	Liquid Pipe	mm (inch)	Ø19.05 (3/4)	Ø19.05 (3/4)	Ø19.05 (3/4)
	Gas Pipe	mm (inch)	Ø41.3 (1-5/8)	Ø41.3 (1-5/8)	Ø41.3 (1-5/8)
Water Connecting Pipes	Inlet	A (inch)	40A (PT 1-1/2) + 40A (PT 1-1/2) + 40A (PT 1-1/2) (Internal Thread)	40A (PT 1-1/2) + 40A (PT 1-1/2) + 40A (PT 1-1/2) (Internal Thread)	40A (PT 1-1/2) + 40A (PT 1-1/2) + 40A (PT 1-1/2) (Internal Thread)
	Outlet	A (inch)	40A (PT 1-1/2) + 40A (PT 1-1/2) + 40A (PT 1-1/2) (Internal Thread)	40A (PT 1-1/2) + 40A (PT 1-1/2) + 40A (PT 1-1/2) (Internal Thread)	40A (PT 1-1/2) + 40A (PT 1-1/2) + 40A (PT 1-1/2) (Internal Thread)
	Drain Outlet	A (inch)	20A (PT 3/4) (External Thread)	20A (PT 3/4) (External Thread)	20A (PT 3/4) (External Thread)
Dimensions (W x H x D)	mm x No.	(755 x 997 x 500) x 3	(755 x 997 x 500) x 3	(755 x 997 x 500) x 3	
Dimensions (W x H x D) - Shipping	mm x No.	(804 x 1,143 x 630) x 3	(804 x 1,143 x 630) x 3	(804 x 1,143 x 630) x 3	
Net Weight	kg x No.	(140 x 1) + (127 x 2)	(140 x 1) + (127 x 2)	(140 x 1) + (127 x 2)	
Shipping Weight	kg x No.	(150 x 1) + (137 x 2)	(150 x 1) + (137 x 2)	(150 x 1) + (137 x 2)	
Sound Pressure Level	Cooling	dB(A)	59.7	59.9	60.0
	Heating	dB(A)	62.1	62.3	62.0
Sound Power Level	Cooling	dB(A)	71.7	71.9	74.0
	Heating	dB(A)	74.1	74.3	76.0
Communication Cable	mm ² x No. (VCTF-SB)	1.0 - 1.5 x 2C	1.0 - 1.5 x 2C	1.0 - 1.5 x 2C	
Refrigerant	Refrigerant Name		R410A	R410A	R410A
	Precharged Amount in Factory	kg	14.6	14.6	14.6
	t-CO ₂ eq		30.5	30.5	30.5
	Control		Electronic Expansion Valve	Electronic Expansion Valve	Electronic Expansion Valve
Power Supply	Ø, V, Hz	3, 380-415, 50	3, 380-415, 50	3, 380-415, 50	
Number of Maximum Connectable Indoor Units		64	64	64	

- Note
- Maximum numbers are prepared based on assumption that all 2.2kW indoor units are connected. The numbers in parentheses means maximum connectable indoor units in accordance with outdoor units combination (160% - 200%). The recommended ratio is 130%.
 - Due to our policy of innovation some specifications may be changed without notification
 - Performances are based on the following conditions
 - Cooling : Indoor temp 27°C (80.6°F) DB / 19°C (66.2°F) WB, Water inlet temp 30°C (86°F)
 - Heating : Indoor temp 20°C (68°F) DB, Water inlet temp 20°C (68°F)
 - Interconnected Pipe Length is 7.5m and difference of Elevation (Outdoor - Indoor Unit) is 0m.
 - Sound pressure level is measured on the rated condition in the anechoic rooms by ISO 3745 standard. Sound power level is measured on the rated condition in the reverberation rooms by ISO 3741 standard. Therefore, these values can be increased owing to ambient conditions during operation.
 - This product contains Fluorinated Greenhouse Gases. (R410A)
 - Add an anti freeze to circulation water when outdoor unit is operating under 10°C (50°F), and change the DIP switch on main PCB. (For more information on installation section.)

MULTI V WATER IV HEAT PUMP

ARWN500LAS4 / ARWN540LAS4
ARWN600LAS4



HP			50	54	60
Model Name	Combination Unit		ARWN500LAS4	ARWN540LAS4	ARWN600LAS4
	Independent Unit		ARWN200LAS4 ARWN200LAS4 ARWN100LAS4	ARWN200LAS4 ARWN200LAS4 ARWN140LAS4	ARWN200LAS4 ARWN200LAS4 ARWN200LAS4
Capacity	Cooling (Rated)	kW	140.0	151.2	168.0
	Heating (Rated)	kW	157.5	170.1	189.0
Input	Cooling (Rated)	kW	27.49	30.24	33.60
	Heating (Rated)	kW	28.68	31.51	35.01
EER			5.09	5.00	5.00
COP	Rated Capacity		5.49	5.40	5.40
Exterior	Color		Warm Gray / Morning Gray	Warm Gray / Morning Gray	Warm Gray / Morning Gray
	RAL Code (Classic)		RAL 7044 / RAL 7030	RAL 7044 / RAL 7030	RAL 7044 / RAL 7030
Heat Exchanger	Type		Stainless Steel Plate	Stainless Steel Plate	Stainless Steel Plate
	Maximum Pressure Resistance	kgf/cm ²	45	45	45
	Head Loss	kPa	30.1 + 30.1 + 15.8	30.1 + 28.6 + 28.6	30.1 + 30.1 + 30.1
	Rated Water Flow	LPM	192 + 192 + 96	192 + 192 + 135	192 + 192 + 192
	Type		Hermetically Sealed Scroll	Hermetically Sealed Scroll	Hermetically Sealed Scroll
Compressor	Combination x No.		(Inverter) x 3	(Inverter) x 3	(Inverter) x 3
	Motor Output x Number	W x No.	5,300 x 2 + 4,200 x 1	5,300 x 2 + 4,200 x 1	5,300 x 3
	Oil Type		FVC68D (PVE)	FVC68D (PVE)	FVC68D (PVE)
	Oil Charge	cc	8,800	8,800	9,000
Refrigerant Connecting Pipes	Liquid Pipe	mm (inch)	Ø19.05 (3/4)	Ø19.05 (3/4)	Ø19.05 (3/4)
	Gas Pipe	mm (inch)	Ø41.3 (1-5/8)	Ø41.3 (1-5/8)	Ø41.3 (1-5/8)
Water Connecting Pipes	Inlet	A (inch)	40A (PT 1-1/2) + 40A (PT 1-1/2) + 40A (PT 1-1/2) (Internal Thread)	40A (PT 1-1/2) + 40A (PT 1-1/2) + 40A (PT 1-1/2) (Internal Thread)	40A (PT 1-1/2) + 40A (PT 1-1/2) + 40A (PT 1-1/2) (Internal Thread)
	Outlet	A (inch)	40A (PT 1-1/2) + 40A (PT 1-1/2) + 40A (PT 1-1/2) (Internal Thread)	40A (PT 1-1/2) + 40A (PT 1-1/2) + 40A (PT 1-1/2) (Internal Thread)	40A (PT 1-1/2) + 40A (PT 1-1/2) + 40A (PT 1-1/2) (Internal Thread)
	Drain Outlet	A (inch)	20A (PT 3/4) (External Thread)	20A (PT 3/4) (External Thread)	20A (PT 3/4) (External Thread)
Dimensions (W x H x D)	mm x No.		(755 x 997 x 500) x 3	(755 x 997 x 500) x 3	(755 x 997 x 500) x 3
Dimensions (W x H x D) - Shipping	mm x No.		(804 x 1,143 x 630) x 3	(804 x 1,143 x 630) x 3	(804 x 1,143 x 630) x 3
Net Weight	kg x No.		(140 x 2) + (127 x 1)	(140 x 2) + (127 x 1)	140 x 3
Shipping Weight	kg x No.		(150 x 2) + (137 x 1)	(150 x 2) + (137 x 1)	150 x 3
Sound Pressure Level	Cooling	dB(A)	57.8	60.0	56.0
	Heating	dB(A)	63.4	62.0	62.0
Sound Power Level	Cooling	dB(A)	69.8	74.0	70.0
	Heating	dB(A)	75.4	76.0	76.0
Communication Cable	mm ² x No. (VCTF-SB)		1.0 - 1.5 x 2C	1.0 - 1.5 x 2C	1.0 - 1.5 x 2C
Refrigerant	Refrigerant Name		R410A	R410A	R410A
	Precharged Amount in Factory	kg	11.8	11.8	9.0
	t-CO ₂ eq		24.6	24.6	18.8
	Control		Electronic Expansion Valve	Electronic Expansion Valve	Electronic Expansion Valve
Power Supply	Ø, V, Hz		3, 380-415, 50	3, 380-415, 50	3, 380-415, 50
Number of Maximum Connectable Indoor Units			64	64	64

- Note
- Maximum numbers are prepared based on assumption that all 2.2kW indoor units are connected. The numbers in parentheses means maximum connectable indoor units in accordance with outdoor units combination (160% - 200%). The recommended ratio is 130%.
 - Due to our policy of innovation some specifications may be changed without notification
 - Performances are based on the following conditions
 - Cooling : Indoor temp 27°C (80.6°F) DB / 19°C (66.2°F) WB, Water inlet temp 30°C (86°F)
 - Heating : Indoor temp 20°C (68°F) DB, Water inlet temp 20°C (68°F)
 - Interconnected Pipe Length is 7.5m and difference of Elevation (Outdoor - Indoor Unit) is 0m.
 - Sound pressure level is measured on the rated condition in the anechoic rooms by ISO 3745 standard. Sound power level is measured on the rated condition in the reverberation rooms by ISO 3741 standard. Therefore, these values can be increased owing to ambient conditions during operation.
 - This product contains Fluorinated Greenhouse Gases. (R410A)
 - Add an anti freeze to circulation water when outdoor unit is operating under 10°C (50°F), and change the DIP switch on main PCB. (For more information on installation section.)

MULTI V WATER IV HEAT PUMP

ARWN620LAS4 / ARWN640LAS4
ARWN680LAS4



HP			62	64	68
Model Name	Combination Unit		ARWN620LAS4	ARWN640LAS4	ARWN680LAS4
	Independent Unit		ARWN200LAS4 ARWN200LAS4 ARWN140LAS4 ARWN080LAS4	ARWN200LAS4 ARWN200LAS4 ARWN140LAS4 ARWN100LAS4	ARWN200LAS4 ARWN200LAS4 ARWN140LAS4 ARWN140LAS4
Capacity	Cooling (Rated)	kW	173.6	179.2	190.4
	Heating (Rated)	kW	195.3	201.6	214.2
Input	Cooling (Rated)	kW	34.10	35.33	38.08
	Heating (Rated)	kW	35.71	36.85	39.68
EER			5.09	5.07	5.00
COP	Rated Capacity		5.47	5.47	5.40
Exterior	Color		Warm Gray / Morning Gray	Warm Gray / Morning Gray	Warm Gray / Morning Gray
	RAL Code (Classic)		RAL 7044 / RAL 7030	RAL 7044 / RAL 7030	RAL 7044 / RAL 7030
Heat Exchanger	Type		Stainless Steel Plate	Stainless Steel Plate	Stainless Steel Plate
	Maximum Pressure Resistance	kgf/cm ²	45	45	45
	Head Loss	kPa	30.1 + 30.1 + 28.6 + 10.7	30.1 + 30.1 + 28.6 + 15.8	30.1 + 30.1 + 28.6 + 28.6
	Rated Water Flow	LPM	192 + 192 + 135 + 77	192 + 192 + 135 + 96	192 + 192 + 135 + 135
	Type		Hermetically Sealed Scroll	Hermetically Sealed Scroll	Hermetically Sealed Scroll
Compressor	Combination x No.		(Inverter) x 4	(Inverter) x 4	(Inverter) x 4
	Motor Output x Number	W x No.	5,300 x 2 + 4,200 x 2	5,300 x 2 + 4,200 x 2	5,300 x 2 + 4,200 x 2
	Oil Type		FVC68D (PVE)	FVC68D (PVE)	FVC68D (PVE)
	Oil Charge	cc	11,600	11,600	11,600
Refrigerant Connecting Pipes	Liquid Pipe	mm (inch)	Ø22.2 (7/8)	Ø22.2 (7/8)	Ø22.2 (7/8)
	Gas Pipe	mm (inch)	Ø44.5 (1-3/4)	Ø44.5 (1-3/4)	Ø53.98 (2-1/8)
Water Connecting Pipes	Inlet	A (inch)	40A (PT 1-1/2) + 40A (PT 1-1/2) + 40A (PT 1-1/2) + PT40 (Internal Thread)	40A (PT 1-1/2) + 40A (PT 1-1/2) + 40A (PT 1-1/2) + PT40 (Internal Thread)	40A (PT 1-1/2) + 40A (PT 1-1/2) + 40A (PT 1-1/2) + PT40 (Internal Thread)
	Outlet	A (inch)	40A (PT 1-1/2) + 40A (PT 1-1/2) + 40A (PT 1-1/2) + PT40 (Internal Thread)	40A (PT 1-1/2) + 40A (PT 1-1/2) + 40A (PT 1-1/2) + PT40 (Internal Thread)	40A (PT 1-1/2) + 40A (PT 1-1/2) + 40A (PT 1-1/2) + PT40 (Internal Thread)
	Drain Outlet	A (inch)	20A (PT 3/4) (External Thread)	20A (PT 3/4) (External Thread)	20A (PT 3/4) (External Thread)
Dimensions (W x H x D)	mm x No.		(755 x 997 x 500) x 4	(755 x 997 x 500) x 4	(755 x 997 x 500) x 4
Dimensions (W x H x D) - Shipping	mm x No.		(804 x 1,143 x 630) x 4	(804 x 1,143 x 630) x 4	(804 x 1,143 x 630) x 4
Net Weight	kg x No.		(140 x 2) + (127 x 2)	(140 x 2) + (127 x 2)	(140 x 2) + (127 x 2)
Shipping Weight	kg x No.		(150 x 2) + (137 x 2)	(150 x 2) + (137 x 2)	(150 x 2) + (137 x 2)
Sound Pressure Level	Cooling	dB(A)	60.7	60.9	61.0
	Heating	dB(A)	64.2	64.3	63.0
Sound Power Level	Cooling	dB(A)	72.7	72.9	75.0
	Heating	dB(A)	76.2	76.3	77.0
Communication Cable	mm ² x No. (VCTF-SB)		1.0 - 1.5 x 2C	1.0 - 1.5 x 2C	1.0 - 1.5 x 2C
Refrigerant	Refrigerant Name		R410A	R410A	R410A
	Precharged Amount in Factory	kg	17.6	17.6	17.6
	t-CO ₂ eq		36.7	36.7	36.7
	Control		Electronic Expansion Valve	Electronic Expansion Valve	Electronic Expansion Valve
Power Supply	Ø, V, Hz		3, 380-415, 50	3, 380-415, 50	3, 380-415, 50
Number of Maximum Connectable Indoor Units			64	64	64

- Note
- Maximum numbers are prepared based on assumption that all 2.2kW indoor units are connected. The numbers in parentheses means maximum connectable indoor units in accordance with outdoor units combination (160% - 200%). The recommended ratio is 130%.
 - Due to our policy of innovation some specifications may be changed without notification
 - Performances are based on the following conditions
 - Cooling : Indoor temp 27°C (80.6°F) DB / 19°C (66.2°F) WB, Water inlet temp 30°C (86°F)
 - Heating : Indoor temp 20°C (68°F) DB, Water inlet temp 20°C (68°F)
 - Interconnected Pipe Length is 7.5m and difference of Elevation (Outdoor - Indoor Unit) is 0m.
 - Sound pressure level is measured on the rated condition in the anechoic rooms by ISO 3745 standard. Sound power level is measured on the rated condition in the reverberation rooms by ISO 3741 standard. Therefore, these values can be increased owing to ambient conditions during operation.
 - This product contains Fluorinated Greenhouse Gases. (R410A)
 - Add an anti freeze to circulation water when outdoor unit is operating under 10°C (50°F), and change the DIP switch on main PCB. (For more information on installation section.)

MULTI V WATER IV HEAT PUMP

ARWN700LAS4 / ARWN740LAS4
ARWN800LAS4



HP		70	74	80	
Model Name	Combination Unit	ARWN700LAS4	ARWN740LAS4	ARWN800LAS4	
	Independent Unit	ARWN200LAS4 ARWN200LAS4 ARWN200LAS4 ARWN100LAS4	ARWN200LAS4 ARWN200LAS4 ARWN200LAS4 ARWN140LAS4	ARWN200LAS4 ARWN200LAS4 ARWN200LAS4 ARWN200LAS4	
Capacity	Cooling (Rated) kW	196.0	207.2	224.0	
	Heating (Rated) kW	220.5	233.1	252.0	
Input	Cooling (Rated) kW	38.69	41.44	44.80	
	Heating (Rated) kW	40.35	43.18	46.68	
EER		5.07	5.00	5.00	
COP	Rated Capacity	5.46	5.40	5.40	
Exterior	Color	Warm Gray / Morning Gray	Warm Gray / Morning Gray	Warm Gray / Morning Gray	
	RAL Code (Classic)	RAL 7044 / RAL 7030	RAL 7044 / RAL 7030	RAL 7044 / RAL 7030	
Heat Exchanger	Type	Stainless Steel Plate	Stainless Steel Plate	Stainless Steel Plate	
	Maximum Pressure Resistance	kgf/cm ²	45	45	
	Head Loss	kPa	30.1 + 30.1 + 30.1 + 15.8	30.1 + 30.1 + 30.1 + 28.6	30.1 + 30.1 + 30.1 + 30.1
	Rated Water Flow	LPM	192 + 192 + 192 + 96	192 + 192 + 192 + 135	192 + 192 + 192 + 192
Compressor	Type	Hermetically Sealed Scroll	Hermetically Sealed Scroll	Hermetically Sealed Scroll	
	Combination x No.	(Inverter) x 4	(Inverter) x 4	(Inverter) x 4	
	Motor Output x Number	W x No.	5,300 x 3 + 4,200 x 1	5,300 x 3 + 4,200 x 1	5,300 x 4
	Oil Type	FVC68D (PVE)	FVC68D (PVE)	FVC68D (PVE)	
Refrigerant Connecting Pipes	Liquid Pipe	mm (inch)	Ø22.2 (7/8)	Ø22.2 (7/8)	
	Gas Pipe	mm (inch)	Ø53.98 (2-1/8)	Ø53.98 (2-1/8)	
Water Connecting Pipes	Inlet	A (inch)	40A (PT 1-1/2) + 40A (PT 1-1/2) + 40A (PT 1-1/2) + PT40 (Internal Thread)	40A (PT 1-1/2) + 40A (PT 1-1/2) + 40A (PT 1-1/2) + PT40 (Internal Thread)	
	Outlet	A (inch)	40A (PT 1-1/2) + 40A (PT 1-1/2) + 40A (PT 1-1/2) + PT40 (Internal Thread)	40A (PT 1-1/2) + 40A (PT 1-1/2) + 40A (PT 1-1/2) + PT40 (Internal Thread)	
	Drain Outlet	A (inch)	20A (PT 3/4) (External Thread)	20A (PT 3/4) (External Thread)	
Dimensions (W x H x D)	mm x No.	(755 x 997 x 500) x 4	(755 x 997 x 500) x 4	(755 x 997 x 500) x 4	
Dimensions (W x H x D) - Shipping	mm x No.	(804 x 1,143 x 630) x 4	(804 x 1,143 x 630) x 4	(804 x 1,143 x 630) x 4	
Net Weight	kg x No.	(140 x 3) + (127 x 1)	(140 x 3) + (127 x 1)	140 x 4	
Shipping Weight	kg x No.	(150 x 3) + (137 x 1)	(150 x 3) + (137 x 1)	150 x 4	
Sound Pressure Level	Cooling	dB(A)	59.3	61.0	
	Heating	dB(A)	65.1	63.0	
Sound Power Level	Cooling	dB(A)	71.3	75.0	
	Heating	dB(A)	77.1	77.0	
Communication Cable	mm ² x No. (VCTF-SB)	1.0 - 1.5 x 2C	1.0 - 1.5 x 2C	1.0 - 1.5 x 2C	
Refrigerant	Refrigerant Name		R410A	R410A	
	Precharged Amount in Factory	kg	14.8	14.8	
	t-CO ₂ eq		30.9	25.1	
	Control		Electronic Expansion Valve	Electronic Expansion Valve	
Power Supply	Ø, V, Hz	3, 380-415, 50	3, 380-415, 50	3, 380-415, 50	
Number of Maximum Connectable Indoor Units ¹⁾		64	64	64	

Note
 1. Maximum numbers are prepared based on assumption that all 2.2kW indoor units are connected. The numbers in parentheses means maximum connectable indoor units in accordance with outdoor units combination (160% - 200%). The recommended ratio is 130%.
 2. Due to our policy of innovation some specifications may be changed without notification
 3. Performances are based on the following conditions
 - Cooling : Indoor temp 27°C (80.6°F) DB / 19°C (66.2°F) WB, Water inlet temp 30°C (86°F)
 - Heating : Indoor temp 20°C (68°F) DB, Water inlet temp 20°C (68°F)
 - Interconnected Pipe Length is 7.5m and difference of Elevation (Outdoor - Indoor Unit) is 0m.
 4. Sound pressure level is measured on the rated condition in the anechoic rooms by ISO 3745 standard. Sound power level is measured on the rated condition in the reverberation rooms by ISO 3741 standard. Therefore, these values can be increased owing to ambient conditions during operation.
 5. This product contains Fluorinated Greenhouse Gases. (R410A)
 6. Add an anti freeze to circulation water when outdoor unit is operating under 10°C (50°F), and change the DIP switch on main PCB. (For more information on installation section.)

MULTI V WATER IV HEAT RECOVERY

ARWB080LAS4 / ARWB100LAS4
ARWB140LAS4



HP		8	10	14
Model Name	Combination Unit	ARWB080LAS4	ARWB100LAS4	ARWB140LAS4
	Independent Unit	ARWB080LAS4	ARWB100LAS4	ARWB140LAS4
Capacity	Cooling (Rated) kW	22.4	28.0	39.2
	Heating (Rated) kW	25.2	31.5	44.1
Input	Cooling (Rated) kW	3.86	5.09	7.84
	Heating (Rated) kW	4.20	5.34	8.17
EER		5.80	5.50	5.00
COP	Rated Capacity	6.00	5.90	5.40
Exterior	Color	Warm Gray / Morning Gray	Warm Gray / Morning Gray	Warm Gray / Morning Gray
	RAL Code (Classic)	RAL 7044 / RAL 7030	RAL 7044 / RAL 7030	RAL 7044 / RAL 7030
Heat Exchanger	Type	Stainless Steel Plate	Stainless Steel Plate	Stainless Steel Plate
	Maximum Pressure Resistance	kgf/cm ²	45	45
	Head Loss	kPa	10.7	15.8
	Rated Water Flow	LPM	77	96
Compressor	Type	Hermetically Sealed Scroll	Hermetically Sealed Scroll	Hermetically Sealed Scroll
	Combination x No.	(Inverter) x 1	(Inverter) x 1	(Inverter) x 1
	Motor Output x Number	W x No.	4,200 x 1	4,200 x 1
	Oil Type	FVC68D (PVE)	FVC68D (PVE)	FVC68D (PVE)
Refrigerant Connecting Pipes	Liquid Pipe	mm (inch)	Ø9.52 (3/8)	Ø12.7 (1/2)
	Low Pressure Gas Pipe	mm (inch)	Ø22.2 (7/8)	Ø25.4 (1)
	High Pressure Gas Pipe	mm (inch)	Ø19.05 (3/4)	Ø19.05 (3/4)
Water Connecting Pipes	Inlet	A (inch)	40A (PT 1-1/2) (Internal Thread)	40A (PT 1-1/2) (Internal Thread)
	Outlet	A (inch)	40A (PT 1-1/2) (Internal Thread)	40A (PT 1-1/2) (Internal Thread)
	Drain Outlet	A (inch)	20A (PT 3/4) (External Thread)	20A (PT 3/4) (External Thread)
Dimensions (W x H x D)	mm x No.	(755 x 997 x 500) x 1	(755 x 997 x 500) x 1	(755 x 997 x 500) x 1
Dimensions (W x H x D) - Shipping	mm x No.	(804 x 1,143 x 630) x 1	(804 x 1,143 x 630) x 1	(804 x 1,143 x 630) x 1
Net Weight	kg x No.	127 x 1	127 x 1	127 x 1
Shipping Weight	kg x No.	137 x 1	137 x 1	137 x 1
Sound Pressure Level	Cooling	dB(A)	47.0	50.0
	Heating	dB(A)	51.0	53.0
Sound Power Level	Cooling	dB(A)	59.0	62.0
	Heating	dB(A)	63.0	65.0
Communication Cable	mm ² x No. (VCTF-SB)	1.0 - 1.5 x 2C	1.0 - 1.5 x 2C	1.0 - 1.5 x 2C
Refrigerant	Refrigerant Name		R410A	R410A
	Precharged Amount in Factory	kg	5.8	5.8
	t-CO ₂ eq		12.1	12.1
	Control		Electronic Expansion Valve	Electronic Expansion Valve
Power Supply	Ø, V, Hz	3, 380-415, 50	3, 380-415, 50	3, 380-415, 50
Number of Maximum Connectable Indoor Units ¹⁾		13 (20)	16 (25)	23 (35)

Note
 1. Maximum numbers are prepared based on assumption that all 2.2kW indoor units are connected. The numbers in parentheses means maximum connectable indoor units in accordance with outdoor units combination (160% - 200%). The recommended ratio is 130%.
 2. Due to our policy of innovation some specifications may be changed without notification
 3. Performances are based on the following conditions
 - Cooling : Indoor temp 27°C (80.6°F) DB / 19°C (66.2°F) WB, Water inlet temp 30°C (86°F)
 - Heating : Indoor temp 20°C (68°F) DB, Water inlet temp 20°C (68°F)
 - Interconnected Pipe Length is 7.5m and difference of Elevation (Outdoor - Indoor Unit) is 0m.
 4. Sound pressure level is measured on the rated condition in the anechoic rooms by ISO 3745 standard. Sound power level is measured on the rated condition in the reverberation rooms by ISO 3741 standard. Therefore, these values can be increased owing to ambient conditions during operation.
 5. This product contains Fluorinated Greenhouse Gases. (R410A)
 6. Add an anti freeze to circulation water when outdoor unit is operating under 10°C (50°F), and change the DIP switch on main PCB. (For more information on installation section.)

MULTI V WATER IV HEAT RECOVERY

ARWB200LAS4 / ARWB160LAS4
ARWB180LAS4



HP		20	16	18	
Model Name	Combination Unit	ARWB200LAS4	ARWB160LAS4	ARWB180LAS4	
	Independent Unit	ARWB200LAS4	ARWB080LAS4 ARWB080LAS4	ARWB100LAS4 ARWB080LAS4	
Capacity	Cooling (Rated) kW	56.0	44.8	50.4	
	Heating (Rated) kW	63.0	50.4	56.7	
Input	Cooling (Rated) kW	11.20	7.72	8.95	
	Heating (Rated) kW	11.67	8.40	9.54	
EER		5.00	5.80	5.63	
COP	Rated Capacity	5.40	6.00	5.94	
Exterior	Color	Warm Gray / Morning Gray	Warm Gray / Morning Gray	Warm Gray / Morning Gray	
	RAL Code (Classic)	RAL 7044 / RAL 7030	RAL 7044 / RAL 7030	RAL 7044 / RAL 7030	
Heat Exchanger	Type	Stainless Steel Plate	Stainless Steel Plate	Stainless Steel Plate	
	Maximum Pressure Resistance	kgf/cm ²	45	45	
	Head Loss	kPa	30.1	10.7 + 10.7	15.8 + 10.7
	Rated Water Flow	LPM	192	77 + 77	96 + 77
	Type		Hermetically Sealed Scroll	Hermetically Sealed Scroll	Hermetically Sealed Scroll
Compressor	Combination x No.	(Inverter) x 1	(Inverter) x 2	(Inverter) x 2	
	Motor Output x Number	W x No.	5,300 x 1	4,200 x 2	4,200 x 2
	Oil Type		FVC68D(PVE)	FVC68D(PVE)	FVC68D(PVE)
	Oil Charge	cc	3,000	5,600	5,600
Refrigerant Connecting Pipes	Liquid Pipe	mm (inch)	Ø12.7 (1/2)	Ø12.7 (1/2)	Ø12.7 (1/2)
	Low Pressure Gas Pipe	mm (inch)	Ø28.58 (1-1/8)	Ø28.58 (1-1/8)	Ø28.58 (1-1/8)
	High Pressure Gas Pipe	mm (inch)	Ø19.05 (3/4)	Ø19.05 (3/4)	Ø19.05 (3/4)
Water Connecting Pipes	Inlet	A (inch)	40A(PT 1-1/2) (Internal Thread)	40A(PT 1-1/2) + 40A(PT 1-1/2) (Internal Thread)	40A(PT 1-1/2) + 40A(PT 1-1/2) (Internal Thread)
	Outlet	A (inch)	40A(PT 1-1/2) (Internal Thread)	40A(PT 1-1/2) + 40A(PT 1-1/2) (Internal Thread)	40A(PT 1-1/2) + 40A(PT 1-1/2) (Internal Thread)
	Drain Outlet	A (inch)	20A(PT 3/4) (External Thread)	20A(PT 3/4) (External Thread)	20A(PT 3/4) (External Thread)
Dimensions (W x H x D)	mm x No.	(755 x 997 x 500) x 1	(755 x 997 x 500) x 2	(755 x 997 x 500) x 2	
Dimensions (W x H x D) - Shipping	mm x No.	(804 x 1,143 x 630) x 1	(804 x 1,143 x 630) x 2	(804 x 1,143 x 630) x 2	
Net Weight	kg x No.	140 x 1	127 x 2	127 x 2	
Shipping Weight	kg x No.	150 x 1	137 x 2	137 x 2	
Sound Pressure Level	Cooling	dB(A)	54.0	50.0	52.0
	Heating	dB(A)	60.0	54.0	55.0
Sound Power Level	Cooling	dB(A)	66.0	62.0	64.0
	Heating	dB(A)	72.0	66.0	67.0
Communication Cable	mm ² x No. (VCTF-SB)		1.0 - 1.5 x 2C	1.0 - 1.5 x 2C	1.0 - 1.5 x 2C
Refrigerant	Refrigerant Name		R410A	R410A	R410A
	Precharged Amount in Factory	kg	3.0	11.6	11.6
	t-CO ₂ eq		6.3	24.2	24.2
	Control		Electronic Expansion Valve	Electronic Expansion Valve	Electronic Expansion Valve
Power Supply	Ø, V, Hz		3, 380-415, 50	3, 380-415, 50	3, 380-415, 50
Number of Maximum Connectable Indoor Units			32(50)	26(40)	29(45)

- Note
- Maximum numbers are prepared based on assumption that all 2.2kW indoor units are connected. The numbers in parentheses means maximum connectable indoor units in accordance with outdoor units combination (160% - 200%). The recommended ratio is 130%.
 - Due to our policy of innovation some specifications may be changed without notification
 - Performances are based on the following conditions
 - Cooling : Indoor temp 27°C (80.6°F) DB / 19°C (66.2°F) WB, Water inlet temp 30°C (86°F)
 - Heating : Indoor temp 20°C (68°F) DB, Water inlet temp 20°C (68°F)
 - Interconnected Pipe Length is 7.5m and difference of Elevation (Outdoor - Indoor Unit) is 0m.
 - Sound pressure level is measured on the rated condition in the anechoic rooms by ISO 3745 standard. Sound power level is measured on the rated condition in the reverberation rooms by ISO 3741 standard. Therefore, these values can be increased owing to ambient conditions during operation.
 - This product contains Fluorinated Greenhouse Gases. (R410A)
 - Add an anti freeze to circulation water when outdoor unit is operating under 10°C (50°F), and change the DIP switch on main PCB. (For more information on installation section.)

MULTI V WATER IV HEAT RECOVERY

ARWB220LAS4 / ARWB240LAS4
ARWB280LAS4



HP		22	24	28	
Model Name	Combination Unit	ARWB220LAS4	ARWB240LAS4	ARWB280LAS4	
	Independent Unit	ARWB140LAS4 ARWB080LAS4	ARWB140LAS4 ARWB100LAS4	ARWB140LAS4 ARWB140LAS4	
Capacity	Cooling (Rated) kW	61.6	67.2	78.4	
	Heating (Rated) kW	69.3	75.6	88.2	
Input	Cooling (Rated) kW	11.70	12.93	15.68	
	Heating (Rated) kW	12.37	13.51	16.34	
EER		5.26	5.20	5.00	
COP	Rated Capacity	5.60	5.60	5.40	
Exterior	Color	Warm Gray / Morning Gray	Warm Gray / Morning Gray	Warm Gray / Morning Gray	
	RAL Code (Classic)	RAL 7044 / RAL 7030	RAL 7044 / RAL 7030	RAL 7044 / RAL 7030	
Heat Exchanger	Type	Stainless Steel Plate	Stainless Steel Plate	Stainless Steel Plate	
	Maximum Pressure Resistance	kgf/cm ²	45	45	
	Head Loss	kPa	28.6 + 10.7	28.6 + 15.8	28.6 + 28.6
	Rated Water Flow	LPM	135 + 77	135 + 96	135 + 135
	Type		Hermetically Sealed Scroll	Hermetically Sealed Scroll	Hermetically Sealed Scroll
Compressor	Combination x No.	(Inverter) x 2	(Inverter) x 2	(Inverter) x 2	
	Motor Output x Number	W x No.	4,200 x 2	4,200 x 2	4,200 x 2
	Oil Type		FVC68D (PVE)	FVC68D (PVE)	FVC68D (PVE)
	Oil Charge	cc	5,600	5,600	5,600
Refrigerant Connecting Pipes	Liquid Pipe	mm (inch)	Ø19.05 (3/4)	Ø19.05 (3/4)	Ø19.05 (3/4)
	Low Pressure Gas Pipe	mm (inch)	Ø34.9 (1-3/8)	Ø34.9 (1-3/8)	Ø34.9 (1-3/8)
	High Pressure Gas Pipe	mm (inch)	Ø28.58 (1-1/8)	Ø28.58 (1-1/8)	Ø28.58 (1-1/8)
Water Connecting Pipes	Inlet	A (inch)	40A (PT 1-1/2) + 40A (PT 1-1/2) (Internal Thread)	40A (PT 1-1/2) + 40A (PT 1-1/2) (Internal Thread)	40A (PT 1-1/2) + 40A (PT 1-1/2) (Internal Thread)
	Outlet	A (inch)	40A (PT 1-1/2) + 40A (PT 1-1/2) (Internal Thread)	40A (PT 1-1/2) + 40A (PT 1-1/2) (Internal Thread)	40A (PT 1-1/2) + 40A (PT 1-1/2) (Internal Thread)
	Drain Outlet	A (inch)	20A (PT 3/4) (External Thread)	20A (PT 3/4) (External Thread)	20A (PT 3/4) (External Thread)
Dimensions (W x H x D)	mm x No.	(755 x 997 x 500) x 2	(755 x 997 x 500) x 2	(755 x 997 x 500) x 2	
Dimensions (W x H x D) - Shipping	mm x No.	(804 x 1,143 x 630) x 2	(804 x 1,143 x 630) x 2	(804 x 1,143 x 630) x 2	
Net Weight	kg x No.	127 x 2	127 x 2	127 x 2	
Shipping Weight	kg x No.	137 x 2	137 x 2	137 x 2	
Sound Pressure Level	Cooling	dB(A)	58.0	59.0	59.0
	Heating	dB(A)	58.0	58.0	58.0
Sound Power Level	Cooling	dB(A)	70.0	71.0	72.0
	Heating	dB(A)	70.0	70.0	71.0
Communication Cable	mm ² x No. (VCTF-SB)		1.0 - 1.5 x 2C	1.0 - 1.5 x 2C	1.0 - 1.5 x 2C
Refrigerant	Refrigerant Name		R410A	R410A	R410A
	Precharged Amount in Factory	kg	11.6	11.6	11.6
	t-CO ₂ eq		24.2	24.2	24.2
	Control		Electronic Expansion Valve	Electronic Expansion Valve	Electronic Expansion Valve
Power Supply	Ø, V, Hz		3, 380-415, 50	3, 380-415, 50	3, 380-415, 50
Number of Maximum Connectable Indoor Units			35 (44)	39 (48)	45 (56)

- Note
- Maximum numbers are prepared based on assumption that all 2.2kW indoor units are connected. The numbers in parentheses means maximum connectable indoor units in accordance with outdoor units combination (160% - 200%). The recommended ratio is 130%.
 - Due to our policy of innovation some specifications may be changed without notification
 - Performances are based on the following conditions
 - Cooling : Indoor temp 27°C (80.6°F) DB / 19°C (66.2°F) WB, Water inlet temp 30°C (86°F)
 - Heating : Indoor temp 20°C (68°F) DB, Water inlet temp 20°C (68°F)
 - Interconnected Pipe Length is 7.5m and difference of Elevation (Outdoor - Indoor Unit) is 0m.
 - Sound pressure level is measured on the rated condition in the anechoic rooms by ISO 3745 standard. Sound power level is measured on the rated condition in the reverberation rooms by ISO 3741 standard. Therefore, these values can be increased owing to ambient conditions during operation.
 - This product contains Fluorinated Greenhouse Gases. (R410A)
 - Add an anti freeze to circulation water when outdoor unit is operating under 10°C (50°F), and change the DIP switch on main PCB. (For more information on installation section.)

MULTI V WATER IV HEAT RECOVERY

ARWB300LAS4 / ARWB340LAS4
ARWB400LAS4



HP		30	34	40	
Model Name	Combination Unit	ARWB300LAS4	ARWB340LAS4	ARWB400LAS4	
	Independent Unit	ARWB200LAS4 ARWB100LAS4	ARWB200LAS4 ARWB140LAS4	ARWB200LAS4 ARWB200LAS4	
Capacity	Cooling (Rated) kW	84.0	95.2	112.0	
	Heating (Rated) kW	94.5	107.1	126.0	
Input	Cooling (Rated) kW	16.29	19.04	22.40	
	Heating (Rated) kW	17.01	19.84	23.34	
EER		5.16	5.00	5.00	
COP	Rated Capacity	5.56	5.40	5.40	
Exterior	Color	Warm Gray / Morning Gray	Warm Gray / Morning Gray	Warm Gray / Morning Gray	
	RAL Code (Classic)	RAL 7044 / RAL 7030	RAL 7044 / RAL 7030	RAL 7044 / RAL 7030	
Heat Exchanger	Type	Stainless Steel Plate	Stainless Steel Plate	Stainless Steel Plate	
	Maximum Pressure Resistance	kgf/cm ²	45	45	
	Head Loss	kPa	30.1 + 15.8	30.1 + 28.6	30.1 + 30.1
	Rated Water Flow	LPM	192 + 96	192 + 135	192 + 192
	Type		Hermetically Sealed Scroll	Hermetically Sealed Scroll	Hermetically Sealed Scroll
Compressor	Combination x No.	(Inverter) x 2	(Inverter) x 2	(Inverter) x 2	
	Motor Output x Number	W x No.	5,300 x 1 + 4,200 x 1	5,300 x 1 + 4,200 x 1	5,300 x 2
	Oil Type		FVC68D (PVE)	FVC68D (PVE)	FVC68D (PVE)
	Oil Charge	cc	5,800	5,800	6,000
Refrigerant Connecting Pipes	Liquid Pipe	mm (inch)	Ø19.05 (3/4)	Ø19.05 (3/4)	Ø19.05 (3/4)
	Low Pressure Gas Pipe	mm (inch)	Ø34.9 (1-3/8)	Ø34.9 (1-3/8)	Ø41.3 (1-5/8)
	High Pressure Gas Pipe	mm (inch)	Ø28.58 (1-1/8)	Ø28.58 (1-1/8)	Ø34.9 (1-3/8)
Water Connecting Pipes	Inlet	A (inch)	40A (PT 1-1/2) + 40A (PT 1-1/2) (Internal Thread)	40A (PT 1-1/2) + 40A (PT 1-1/2) (Internal Thread)	40A (PT 1-1/2) + 40A (PT 1-1/2) (Internal Thread)
	Outlet	A (inch)	40A (PT 1-1/2) + 40A (PT 1-1/2) (Internal Thread)	40A (PT 1-1/2) + 40A (PT 1-1/2) (Internal Thread)	40A (PT 1-1/2) + 40A (PT 1-1/2) (Internal Thread)
	Drain Outlet	A (inch)	20A (PT 3/4) (External Thread)	20A (PT 3/4) (External Thread)	20A (PT 3/4) (External Thread)
Dimensions (W x H x D)	mm x No.	(755 x 997 x 500) x 2	(755 x 997 x 500) x 2	(755 x 997 x 500) x 2	
Dimensions (W x H x D) - Shipping	mm x No.	(804 x 1,143 x 630) x 2	(804 x 1,143 x 630) x 2	(804 x 1,143 x 630) x 2	
Net Weight	kg x No.	(140 x 1) + (127 x 1)	(140 x 1) + (127 x 1)	140 x 2	
Shipping Weight	kg x No.	(150 x 1) + (137 x 1)	(150 x 1) + (137 x 1)	150 x 2	
Sound Pressure Level	Cooling	dB(A)	55.0	59.0	55.0
	Heating	dB(A)	61.0	61.0	61.0
Sound Power Level	Cooling	dB(A)	67.0	72.0	68.0
	Heating	dB(A)	73.0	74.0	74.0
Communication Cable	mm ² x No. (VCTF-SB)	1.0 - 1.5 x 2C	1.0 - 1.5 x 2C	1.0 - 1.5 x 2C	
Refrigerant	Refrigerant Name		R410A	R410A	R410A
	Precharged Amount in Factory	kg	8.8	8.8	6.0
	t-CO ₂ eq		18.4	18.4	12.5
	Control		Electronic Expansion Valve	Electronic Expansion Valve	Electronic Expansion Valve
Power Supply	Ø, V, Hz	3, 380-415, 50	3, 380-415, 50	3, 380-415, 50	
Number of Maximum Connectable Indoor Units		49 (60)	55 (64)	64	

- Note
- Maximum numbers are prepared based on assumption that all 2.2kW indoor units are connected. The numbers in parentheses means maximum connectable indoor units in accordance with outdoor units combination (160% - 200%). The recommended ratio is 130%.
 - Due to our policy of innovation some specifications may be changed without notification
 - Performances are based on the following conditions
 - Cooling : Indoor temp 27°C (80.6°F) DB / 19°C (66.2°F) WB, Water inlet temp 30°C (86°F)
 - Heating : Indoor temp 20°C (68°F) DB, Water inlet temp 20°C (68°F)
 - Interconnected Pipe Length is 7.5m and difference of Elevation (Outdoor - Indoor Unit) is 0m.
 - Sound pressure level is measured on the rated condition in the anechoic rooms by ISO 3745 standard. Sound power level is measured on the rated condition in the reverberation rooms by ISO 3741 standard. Therefore, these values can be increased owing to ambient conditions during operation.
 - This product contains Fluorinated Greenhouse Gases. (R410A)
 - Add an anti freeze to circulation water when outdoor unit is operating under 10°C (50°F), and change the DIP switch on main PCB. (For more information on installation section.)

MULTI V WATER IV HEAT RECOVERY

ARWB420LAS4 / ARWB440LAS4
ARWB480LAS4



HP		42	44	48	
Model Name	Combination Unit	ARWB420LAS4	ARWB440LAS4	ARWB480LAS4	
	Independent Unit	ARWB200LAS4 ARWB140LAS4 ARWB080LAS4	ARWB200LAS4 ARWB140LAS4 ARWB100LAS4	ARWB200LAS4 ARWB140LAS4 ARWB140LAS4	
Capacity	Cooling (Rated) kW	117.6	123.2	134.4	
	Heating (Rated) kW	132.3	138.6	151.2	
Input	Cooling (Rated) kW	22.9	24.13	26.88	
	Heating (Rated) kW	24.04	25.18	28.01	
EER		5.14	5.11	5.00	
COP	Rated Capacity	5.50	5.50	5.40	
Exterior	Color	Warm Gray / Morning Gray	Warm Gray / Morning Gray	Warm Gray / Morning Gray	
	RAL Code (Classic)	RAL 7044 / RAL 7030	RAL 7044 / RAL 7030	RAL 7044 / RAL 7030	
Heat Exchanger	Type	Stainless Steel Plate	Stainless Steel Plate	Stainless Steel Plate	
	Maximum Pressure Resistance	kgf/cm ²	45	45	
	Head Loss	kPa	30.1 + 28.6 + 10.7	30.1 + 28.6 + 15.8	30.1 + 28.6 + 28.6
	Rated Water Flow	LPM	192 + 135 + 77	192 + 135 + 96	192 + 135 + 135
	Type		Hermetically Sealed Scroll	Hermetically Sealed Scroll	Hermetically Sealed Scroll
Compressor	Combination x No.	(Inverter) x 3	(Inverter) x 3	(Inverter) x 3	
	Motor Output x Number	W x No.	5,300 x 1 + 4,200 x 2	5,300 x 1 + 4,200 x 2	5,300 x 1 + 4,200 x 2
	Oil Type		FVC68D (PVE)	FVC68D (PVE)	FVC68D (PVE)
	Oil Charge	cc	8,600	8,600	8,600
Refrigerant Connecting Pipes	Liquid Pipe	mm (inch)	Ø19.05 (3/4)	Ø19.05 (3/4)	Ø19.05 (3/4)
	Low Pressure Gas Pipe	mm (inch)	Ø41.3 (1-5/8)	Ø41.3 (1-5/8)	Ø41.3 (1-5/8)
	High Pressure Gas Pipe	mm (inch)	Ø34.9 (1-3/8)	Ø34.9 (1-3/8)	Ø34.9 (1-3/8)
Water Connecting Pipes	Inlet	A (inch)	40A (PT 1-1/2) + 40A (PT 1-1/2) + 40A (PT 1-1/2) (Internal Thread)	40A (PT 1-1/2) + 40A (PT 1-1/2) + 40A (PT 1-1/2) (Internal Thread)	40A (PT 1-1/2) + 40A (PT 1-1/2) + 40A (PT 1-1/2) (Internal Thread)
	Outlet	A (inch)	40A (PT 1-1/2) + 40A (PT 1-1/2) + 40A (PT 1-1/2) (Internal Thread)	40A (PT 1-1/2) + 40A (PT 1-1/2) + 40A (PT 1-1/2) (Internal Thread)	40A (PT 1-1/2) + 40A (PT 1-1/2) + 40A (PT 1-1/2) (Internal Thread)
	Drain Outlet	A (inch)	20A (PT 3/4) (External Thread)	20A (PT 3/4) (External Thread)	20A (PT 3/4) (External Thread)
Dimensions (W x H x D)	mm x No.	(755 x 997 x 500) x 3	(755 x 997 x 500) x 3	(755 x 997 x 500) x 3	
Dimensions (W x H x D) - Shipping	mm x No.	(804 x 1,143 x 630) x 3	(804 x 1,143 x 630) x 3	(804 x 1,143 x 630) x 3	
Net Weight	kg x No.	(140 x 1) + (127 x 2)	(140 x 1) + (127 x 2)	(140 x 1) + (127 x 2)	
Shipping Weight	kg x No.	(150 x 1) + (137 x 2)	(150 x 1) + (137 x 2)	(150 x 1) + (137 x 2)	
Sound Pressure Level	Cooling	dB(A)	60.0	60.0	60.0
	Heating	dB(A)	62.0	62.0	62.0
Sound Power Level	Cooling	dB(A)	72.0	72.0	74.0
	Heating	dB(A)	74.0	74.0	76.0
Communication Cable	mm ² x No. (VCTF-SB)	1.0 - 1.5 x 2C	1.0 - 1.5 x 2C	1.0 - 1.5 x 2C	
Refrigerant	Refrigerant Name		R410A	R410A	R410A
	Precharged Amount in Factory	kg	14.6	14.6	14.6
	t-CO ₂ eq		30.5	30.5	30.5
	Control		Electronic Expansion Valve	Electronic Expansion Valve	Electronic Expansion Valve
Power Supply	Ø, V, Hz	3, 380-415, 50	3, 380-415, 50	3, 380-415, 50	
Number of Maximum Connectable Indoor Units		64	64	64	

- Note
- Maximum numbers are prepared based on assumption that all 2.2kW indoor units are connected. The numbers in parentheses means maximum connectable indoor units in accordance with outdoor units combination (160% - 200%). The recommended ratio is 130%.
 - Due to our policy of innovation some specifications may be changed without notification
 - Performances are based on the following conditions
 - Cooling : Indoor temp 27°C (80.6°F) DB / 19°C (66.2°F) WB, Water inlet temp 30°C (86°F)
 - Heating : Indoor temp 20°C (68°F) DB, Water inlet temp 20°C (68°F)
 - Interconnected Pipe Length is 7.5m and difference of Elevation (Outdoor - Indoor Unit) is 0m.
 - Sound pressure level is measured on the rated condition in the anechoic rooms by ISO 3745 standard. Sound power level is measured on the rated condition in the reverberation rooms by ISO 3741 standard. Therefore, these values can be increased owing to ambient conditions during operation.
 - This product contains Fluorinated Greenhouse Gases. (R410A)
 - Add an anti freeze to circulation water when outdoor unit is operating under 10°C (50°F), and change the DIP switch on main PCB. (For more information on installation section.)

MULTI V WATER IV HEAT RECOVERY

ARWB500LAS4 / ARWB540LAS4
ARWB600LAS4



HP		50	54	60	
Model Name	Combination Unit	ARWB500LAS4	ARWB540LAS4	ARWB600LAS4	
	Independent Unit	ARWB200LAS4 ARWB200LAS4 ARWB100LAS4	ARWB200LAS4 ARWB200LAS4 ARWB140LAS4	ARWB200LAS4 ARWB200LAS4 ARWB200LAS4	
Capacity	Cooling (Rated) kW	140.0	151.2	168.0	
	Heating (Rated) kW	157.5	170.1	189.0	
Input	Cooling (Rated) kW	27.49	30.24	33.60	
	Heating (Rated) kW	28.68	31.51	35.01	
EER		5.09	5.00	5.00	
COP	Rated Capacity	5.49	5.40	5.40	
Exterior	Color	Warm Gray / Morning Gray	Warm Gray / Morning Gray	Warm Gray / Morning Gray	
	RAL Code (Classic)	RAL 7044 / RAL 7030	RAL 7044 / RAL 7030	RAL 7044 / RAL 7030	
Heat Exchanger	Type	Stainless Steel Plate	Stainless Steel Plate	Stainless Steel Plate	
	Maximum Pressure Resistance	kgf/cm ²	45	45	
	Head Loss	kPa	30.1 + 30.1 + 15.8	30.1 + 28.6 + 28.6	30.1 + 30.1 + 30.1
	Rated Water Flow	LPM	192 + 192 + 96	192 + 192 + 135	192 + 192 + 192
Compressor	Type	Hermetically Sealed Scroll	Hermetically Sealed Scroll	Hermetically Sealed Scroll	
	Combination x No.	(Inverter) x 3	(Inverter) x 3	(Inverter) x 3	
	Motor Output x Number	W x No.	5,300 x 2 + 4,200 x 1	5,300 x 2 + 4,200 x 1	5,300 x 3
	Oil Type	FVC68D (PVE)	FVC68D (PVE)	FVC68D (PVE)	
Refrigerant Connecting Pipes	Liquid Pipe	mm (inch)	Ø19.05 (3/4)	Ø19.05 (3/4)	
	Low Pressure Gas Pipe	mm (inch)	Ø41.3 (1-5/8)	Ø41.3 (1-5/8)	
	High Pressure Gas Pipe	mm (inch)	Ø34.9 (1-3/8)	Ø34.9 (1-3/8)	
Water Connecting Pipes	Inlet	A (inch)	40A (PT 1-1/2) + 40A (PT 1-1/2) + 40A (PT 1-1/2) (Internal Thread)	40A (PT 1-1/2) + 40A (PT 1-1/2) + 40A (PT 1-1/2) (Internal Thread)	
	Outlet	A (inch)	40A (PT 1-1/2) + 40A (PT 1-1/2) + 40A (PT 1-1/2) (Internal Thread)	40A (PT 1-1/2) + 40A (PT 1-1/2) + 40A (PT 1-1/2) (Internal Thread)	
	Drain Outlet	A (inch)	20A (PT 3/4) (External Thread)	20A (PT 3/4) (External Thread)	
Dimensions (W x H x D)	mm x No.	(755 x 997 x 500) x 3	(755 x 997 x 500) x 3	(755 x 997 x 500) x 3	
Dimensions (W x H x D) - Shipping	mm x No.	(804 x 1,143 x 630) x 3	(804 x 1,143 x 630) x 3	(804 x 1,143 x 630) x 3	
Net Weight	kg x No.	(140 x 2) + (127 x 1)	(140 x 2) + (127 x 1)	140 x 3	
Shipping Weight	kg x No.	(150 x 2) + (137 x 1)	(150 x 2) + (137 x 1)	150 x 3	
Sound Pressure Level	Cooling	dB(A)	58.0	60.0	
	Heating	dB(A)	63.0	62.0	
Sound Power Level	Cooling	dB(A)	70.0	74.0	
	Heating	dB(A)	75.0	76.0	
Communication Cable	mm ² x No. (VCTF-SB)	1.0 - 1.5 x 2C	1.0 - 1.5 x 2C	1.0 - 1.5 x 2C	
Refrigerant	Refrigerant Name	R410A	R410A	R410A	
	Precharged Amount in Factory	kg	11.8	11.8	
	t-CO ₂ eq		24.6	18.8	
	Control	Electronic Expansion Valve	Electronic Expansion Valve	Electronic Expansion Valve	
Power Supply	Ø, V, Hz	3, 380-415, 50	3, 380-415, 50	3, 380-415, 50	
Number of Maximum Connectable Indoor Units		64	64	64	

- Note
- Maximum numbers are prepared based on assumption that all 2.2kW indoor units are connected. The numbers in parentheses means maximum connectable indoor units in accordance with outdoor units combination (160% - 200%). The recommended ratio is 130%.
 - Due to our policy of innovation some specifications may be changed without notification
 - Performances are based on the following conditions
 - Cooling : Indoor temp 27°C (80.6°F) DB / 19°C (66.2°F) WB, Water inlet temp 30°C (86°F)
 - Heating : Indoor temp 20°C (68°F) DB, Water inlet temp 20°C (68°F)
 - Interconnected Pipe Length is 7.5m and difference of Elevation (Outdoor - Indoor Unit) is 0m.
 - Sound pressure level is measured on the rated condition in the anechoic rooms by ISO 3745 standard. Sound power level is measured on the rated condition in the reverberation rooms by ISO 3741 standard. Therefore, these values can be increased owing to ambient conditions during operation.
 - This product contains Fluorinated Greenhouse Gases. (R410A)
 - Add an anti freeze to circulation water when outdoor unit is operating under 10°C (50°F), and change the DIP switch on main PCB. (For more information on installation section.)

MULTI V WATER IV HEAT RECOVERY

ARWB620LAS4 / ARWB640LAS4
ARWB680LAS4



HP		62	64	68	
Model Name	Combination Unit	ARWB620LAS4	ARWB640LAS4	ARWB680LAS4	
	Independent Unit	ARWB200LAS4 ARWB200LAS4 ARWB140LAS4 ARWB080LAS4	ARWB200LAS4 ARWB200LAS4 ARWB140LAS4 ARWB100LAS4	ARWB200LAS4 ARWB200LAS4 ARWB140LAS4 ARWB140LAS4	
Capacity	Cooling (Rated) kW	173.6	179.2	190.4	
	Heating (Rated) kW	195.3	201.6	214.2	
Input	Cooling (Rated) kW	34.10	35.33	38.08	
	Heating (Rated) kW	35.71	36.85	39.68	
EER		5.09	5.07	5.00	
COP	Rated Capacity	5.47	5.47	5.40	
Exterior	Color	Warm Gray / Morning Gray	Warm Gray / Morning Gray	Warm Gray / Morning Gray	
	RAL Code (Classic)	RAL 7044 / RAL 7030	RAL 7044 / RAL 7030	RAL 7044 / RAL 7030	
Heat Exchanger	Type	Stainless Steel Plate	Stainless Steel Plate	Stainless Steel Plate	
	Maximum Pressure Resistance	kgf/cm ²	45	45	
	Head Loss	kPa	30.1 + 30.1 + 28.6 + 10.7	30.1 + 30.1 + 28.6 + 15.8	30.1 + 30.1 + 28.6 + 28.6
	Rated Water Flow	LPM	192 + 192 + 135 + 77	192 + 192 + 135 + 96	192 + 192 + 135 + 135
Compressor	Type	Hermetically Sealed Scroll	Hermetically Sealed Scroll	Hermetically Sealed Scroll	
	Combination x No.	(Inverter) x 4	(Inverter) x 4	(Inverter) x 4	
	Motor Output x Number	W x No.	5,300 x 2 + 4,200 x 2	5,300 x 2 + 4,200 x 2	5,300 x 2 + 4,200 x 2
	Oil Type	FVC68D (PVE)	FVC68D (PVE)	FVC68D (PVE)	
Refrigerant Connecting Pipes	Liquid Pipe	mm (inch)	Ø22.2 (7/8)	Ø22.2 (7/8)	
	Low Pressure Gas Pipe	mm (inch)	Ø44.5 (1-3/4)	Ø44.5 (1-3/4)	
	High Pressure Gas Pipe	mm (inch)	Ø41.3 (1-5/8)	Ø41.3 (1-5/8)	
Water Connecting Pipes	Inlet	A (inch)	40A (PT 1-1/2) + 40A (PT 1-1/2) + 40A (PT 1-1/2) + PT40 (Internal Thread)	40A (PT 1-1/2) + 40A (PT 1-1/2) + 40A (PT 1-1/2) + PT40 (Internal Thread)	
	Outlet	A (inch)	40A (PT 1-1/2) + 40A (PT 1-1/2) + 40A (PT 1-1/2) + PT40 (Internal Thread)	40A (PT 1-1/2) + 40A (PT 1-1/2) + 40A (PT 1-1/2) + PT40 (Internal Thread)	
	Drain Outlet	A (inch)	20A (PT 3/4) (External Thread)	20A (PT 3/4) (External Thread)	
Dimensions (W x H x D)	mm x No.	(755 x 997 x 500) x 4	(755 x 997 x 500) x 4	(755 x 997 x 500) x 4	
Dimensions (W x H x D) - Shipping	mm x No.	(804 x 1,143 x 630) x 4	(804 x 1,143 x 630) x 4	(804 x 1,143 x 630) x 4	
Net Weight	kg x No.	(140 x 2) + (127 x 2)	(140 x 2) + (127 x 2)	(140 x 2) + (127 x 2)	
Shipping Weight	kg x No.	(150 x 2) + (137 x 2)	(150 x 2) + (137 x 2)	(150 x 2) + (137 x 2)	
Sound Pressure Level	Cooling	dB(A)	61.0	61.0	
	Heating	dB(A)	64.0	63.0	
Sound Power Level	Cooling	dB(A)	73.0	75.0	
	Heating	dB(A)	76.0	77.0	
Communication Cable	mm ² x No. (VCTF-SB)	1.0 - 1.5 x 2C	1.0 - 1.5 x 2C	1.0 - 1.5 x 2C	
Refrigerant	Refrigerant Name	R410A	R410A	R410A	
	Precharged Amount in Factory	kg	17.6	17.6	
	t-CO ₂ eq		36.7	36.7	
	Control	Electronic Expansion Valve	Electronic Expansion Valve	Electronic Expansion Valve	
Power Supply	Ø, V, Hz	3, 380-415, 50	3, 380-415, 50	3, 380-415, 50	
Number of Maximum Connectable Indoor Units		64	64	64	

- Note
- Maximum numbers are prepared based on assumption that all 2.2kW indoor units are connected. The numbers in parentheses means maximum connectable indoor units in accordance with outdoor units combination (160% - 200%). The recommended ratio is 130%.
 - Due to our policy of innovation some specifications may be changed without notification
 - Performances are based on the following conditions
 - Cooling : Indoor temp 27°C (80.6°F) DB / 19°C (66.2°F) WB, Water inlet temp 30°C (86°F)
 - Heating : Indoor temp 20°C (68°F) DB, Water inlet temp 20°C (68°F)
 - Interconnected Pipe Length is 7.5m and difference of Elevation (Outdoor - Indoor Unit) is 0m.
 - Sound pressure level is measured on the rated condition in the anechoic rooms by ISO 3745 standard. Sound power level is measured on the rated condition in the reverberation rooms by ISO 3741 standard. Therefore, these values can be increased owing to ambient conditions during operation.
 - This product contains Fluorinated Greenhouse Gases. (R410A)
 - Add an anti freeze to circulation water when outdoor unit is operating under 10°C (50°F), and change the DIP switch on main PCB. (For more information on installation section.)

INDOOR UNITS

WALL MOUNTED / CEILING MOUNTED CASSETTE /
CEILING MOUNTED ROUND CASSETTE /
CEILING CONCEALED DUCT / FRESH AIR INTAKE /
CEILING & FLOOR CONVERTIBLE / CEILING SUSPENDED /
CONSOLE & FLOOR STANDING / COMPATIBILITY /
FEATURE FUNCTIONS



WALL MOUNTED



Features & Benefits

- 6 Different discharge angles can be programmed via the remote controller.
- Easily detachable full surface cover helps to clean the air conditioner.
- Drain pipe can be easily hidden from sight.

Key Applications

- Retail
- Restaurant
- Office
- Hotel
- Multi-family Residence

	Wall Mounted	Artcool Mirror	Artcool Gallery	Standard
Smart	Wi-Fi	○	○	○
Energy Efficiency	Energy Display	○	○	○
Fast Cooling & Heating	Jet Cool	○	○	○
	Auto Swing (Up & Down)	○	○	○
Health	Ionizer	○	-	-7.1kW Only
	Pre Filter	○	○	○
	Auto Cleaning	○	○	○
	Sleep Mode	○	○	○
Comfort	Timer (On / Off)	○	○	○
	Timer (Weekly)	○	○	○
	Two Thermistor Control	○	○	○
	Group Control	○	○	○

※ ○: Applied, - : Not applied

SMART

Wi-Fi Control

Anytime, anywhere access to the unit with Android & iOS-based smartphones.



Search "LG ThinQ" on Google market or the App Store to download the app.

Integrated Home Appliances Control

Control / Monitor all your LG appliances from one place.



Easy Registration and Log-in

Follow the easy set-up steps that will activate LG ThinQ's user-friendly features.



Simple operation for various functions

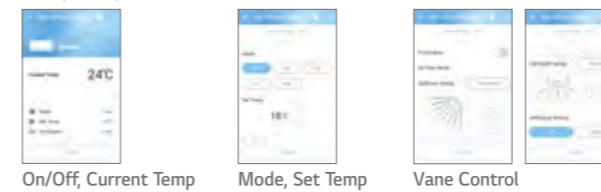

Straight forward Management

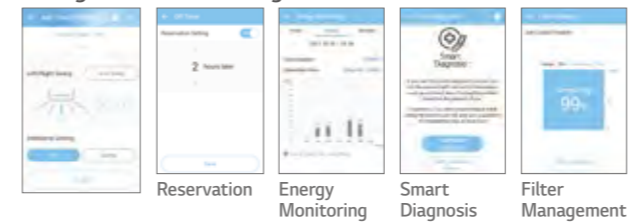

Access your air conditioner anytime and from anywhere with a Wi-Fi equipped device and LG's exclusive control app, LG ThinQ.



Wi-Fi Connectivity

Each user can set and save temperature and fan speed preferences in the LG ThinQ app. If a household has more than one indoor unit, separate temperature settings can be set for each.

Multiple Devices



※ Can be controlled by multiple users, but not simultaneously.

Multi-Control



FRESH AIR

Ionizer^{PLUS}

The powerful Ionizer protects you from bad odors and Escherichia coli and Staphylococcus in the surface with over 3 million ions to sterilize to make a safer, and cleaner environment.

※ Specifications may vary for each model.
 ※ Depending on the experimental conditions.

Sterilization and Deodorization (Utilizes Over 3 Million Ions)

Ionizer+ reduces E.coli and Staphylococcus in the surface with over 3 million ions.

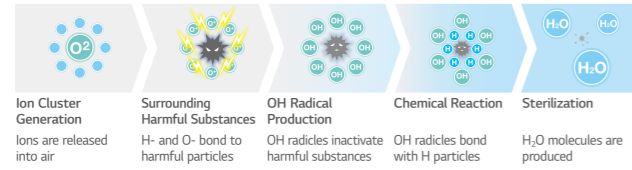

Sterilization Performance Evaluations

Sterilize Bacteria E.coli over 99.9% in 30 min. and staphylococcus over 99.6% in 60min.

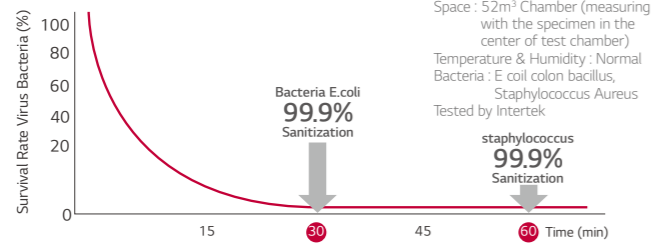

2.1 odor strength decrease in 60 minutes

An odor of measured as 2 European odor units (ouE/m³) or less indicates that the level of odor falls within permissible limits.

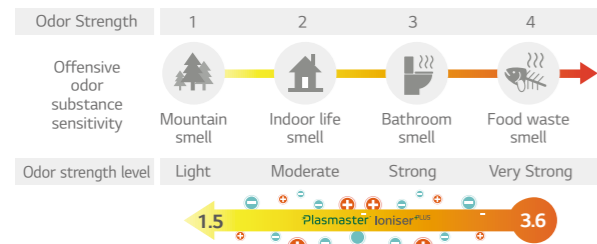

Odor strength reduce 3.6 → 1.5 / The Odor floating in the room as well as curtain and clothes.

※ Test conditions :
 Space : 8m³ Chamber
 Temperature & Humidity : Normal
 Tested by Intertek

Auto Cleaning

The unit has a self-cleaning function that dries the heat exchanger before sterilizing the interior.

Pain Point

The main cause of odor within air conditioners is mold and bacteria growing on the heat exchanger. These germs can spread when the heat exchanger is wet.



Cleans Filter with Regular Airflow

The comprehensive auto cleaning function prevents the formation of bacteria and mold on the heat exchanger.

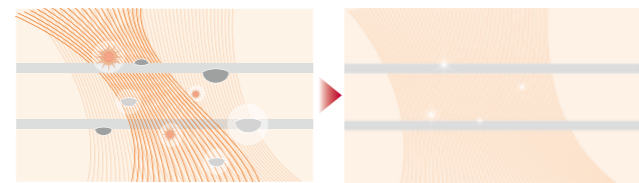
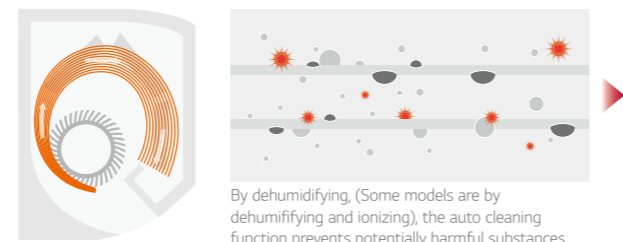

The indoor environment remains odorless with the advanced deodorizing function.

By preventing pollution of the heat exchanger caused by various germs and bacteria, performance and lifespan of the air conditioner can be increased over 10 years.

Auto cleaning

Auto Cleaning provides clean air by preventing bacteria, mold and odors that can otherwise accumulate in an indoor unit.



INSTALLATION

Installation Support Clip

A support clip creates adequate space between the wall and the unit for easier installation.

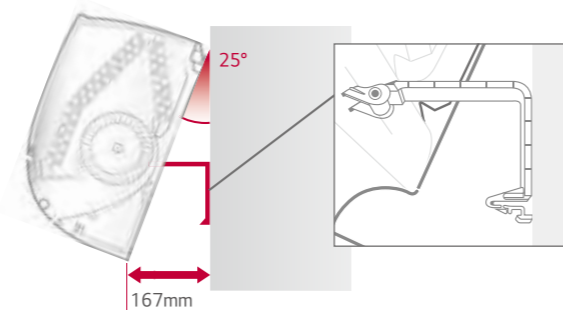

FAST COOLING & HEATING

Auto Swing

Cool air extends to the entire room regardless of where the unit is situated.

※ Specifications may vary for each model.

6-Step Vane Control up to 70°

The vertical vane, which moves up and down, has 6 different settings including full-auto swing.

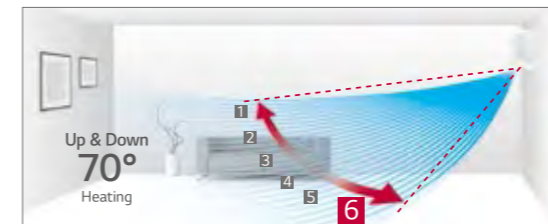

※ Angle can be different from each model and working mode.

Control up to 110°

Louver can be adjusted manually to extend left and right swing to 110 degrees.

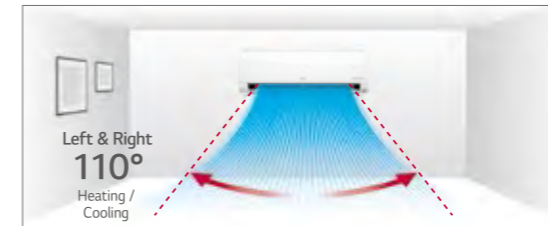

※ Angle can be different from each model and working mode.

Easy and Simple Control

Airflow direction can be changed by LG ThinQ Wi-Fi app.



Jet Cool

LG air conditioners provide optimized high-speed airflow, which can cool rooms faster while delivering cool air evenly in every direction.

※ Specifications may vary for each model.
 ※ Depending on the experimental conditions.

One Click "Jet Mode"

Reduces the temperature of outflowing air to 18°C for 30 minutes with just one click.



More Powerful Performance

By reducing the second vortex, which decreases airflow within the air outlet, and enlarging the fan size, the amount of air flow is increased to 13 CMM.

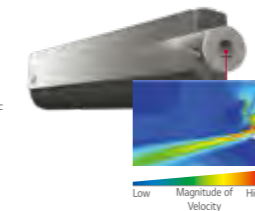

COMFORT

Scheduled Operation

You can set the daily temperature, fan speed, the operation mode and automatic On / Off time for two weeks. It will keep running on that time until cancelled by the user.

※ This function is for wired remote controller only.
 ※ Wired remote controller is need to be separately purchased.

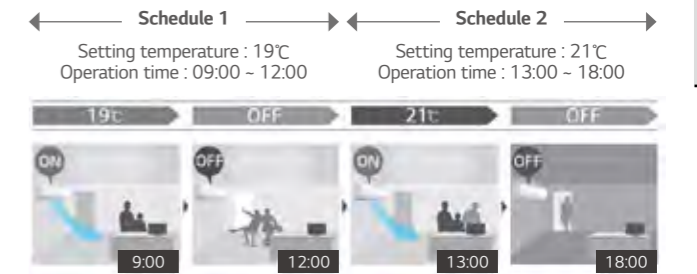

Two Thermistors Control

The indoor temperature can be checked using the thermistors in the remote controller as well as from the indoor unit. There may be a significant difference between ceiling and floor air temperature. Two thermistors can optimise indoor air temperature for a more comfortable environment.

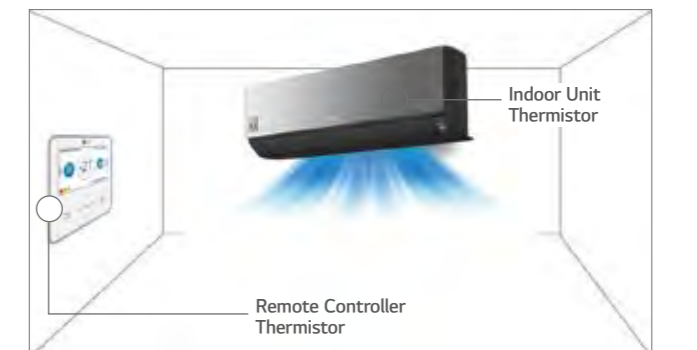

Group Control

Group control by new remote controller (PREMTB100 / PREMTBB10) has more functions than previous model.

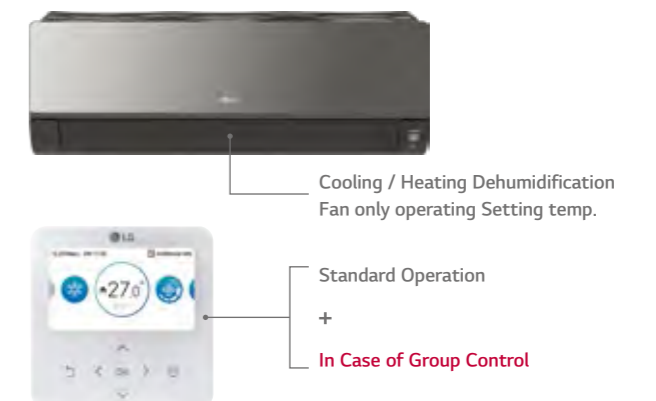

ARTCOOL MIRROR

ARNU05GSJR4 / ARNU07GSJR4
ARNU09GSJR4 / ARNU12GSJR4
ARNU15GSJR4



Model	Unit	ARNU05GSJR4	ARNU07GSJR4	ARNU09GSJR4	ARNU12GSJR4	ARNU15GSJR4
Cooling Capacity	kW	1.6	2.2	2.8	3.6	4.5
Heating Capacity	kW	1.8	2.5	3.2	4.0	5.0
Power Input (H / M / L)	Nominal W	11 / 10 / 9	12 / 11 / 9	13 / 12 / 9	15 / 13 / 11	23 / 18 / 11
Exterior Color		Mirror (Black)	Mirror (Black)	Mirror (Black)	Mirror (Black)	Mirror (Black)
RAL Code		RAL 9005	RAL 9005	RAL 9005	RAL 9005	RAL 9005
Dimensions (W x H x D)	Body mm	837 x 308 x 192	837 x 308 x 192	837 x 308 x 192	837 x 308 x 192	837 x 308 x 192
	Shipping mm	909 x 383 x 256	909 x 383 x 256	909 x 383 x 256	909 x 383 x 256	909 x 383 x 256
	Type	Cross Flow Fan	Cross Flow Fan	Cross Flow Fan	Cross Flow Fan	Cross Flow Fan
Fan	Motor Output x Number W x No.	30 x 1	30 x 1	30 x 1	30 x 1	30 x 1
	Air Flow Rate (H / M / L) m³/min	6.8 / 6.5 / 5.9	7.2 / 6.8 / 5.9	7.8 / 7.2 / 5.9	8.5 / 7.8 / 6.8	10.5 / 9.5 / 6.8
	Motor Type	BLDC	BLDC	BLDC	BLDC	BLDC
Air Filter		Pre Filter	Pre Filter	Pre Filter	Pre Filter	Pre Filter
Pipe Connections	Liquid Side mm (inch)	Ø6.35 (1/4)	Ø6.35 (1/4)	Ø6.35 (1/4)	Ø6.35 (1/4)	Ø6.35 (1/4)
	Gas Side mm (inch)	Ø12.7 (1/2)	Ø12.7 (1/2)	Ø12.7 (1/2)	Ø12.7 (1/2)	Ø12.7 (1/2)
	Drain Pipe (Internal Dia.) mm (inch)	Ø16 (5/8)	Ø16 (5/8)	Ø16 (5/8)	Ø16 (5/8)	Ø16 (5/8)
Weight	Body kg	9.2	9.2	9.2	9.2	9.2
Sound Pressure Levels (H / M / L)	dB(A)	30 / 29 / 28	32 / 30 / 28	34 / 32 / 28	37 / 34 / 30	42 / 39 / 32
Sound Power Levels (H / M / L)	dB(A)	54 / 53 / 52	54 / 53 / 52	55 / 54 / 52	55 / 54 / 53	58 / 56 / 54
Power Supply	Ø, V, Hz	1, 220-240, 50	1, 220-240, 50	1, 220-240, 50	1, 220-240, 50	1, 220-240, 50
Communication Cable	mm² x No.	1.0 - 1.5 x 2C	1.0 - 1.5 x 2C	1.0 - 1.5 x 2C	1.0 - 1.5 x 2C	1.0 - 1.5 x 2C

Note : 1. Performance tested under EN14511
2. Capacities are based on the following conditions
- Cooling : Indoor temp. 27°C (80.6°F) DB / 19°C (66.2°F) WB, Outdoor temp. 35°C (95°F) DB / 24°C (75.2°F) WB, Interconnecting piping length 7.5m, Level difference of zero
- Heating : Indoor temp. 20°C (68°F) DB / 15°C (59°F) WB, Outdoor temp. 7°C (44.6°F) DB / 6°C (42.8°F) WB, Interconnecting piping length 7.5m, Level difference of zero
3. Due to our policy of innovation, some specifications may be changed without notification

Accessories

Chassis	ARNU05GSJR4	ARNU07GSJR4	ARNU09GSJR4	ARNU12GSJR4	ARNU15GSJR4
Drain Pump			-		
Cassette Cover			-		
Refrigerant Leakage Detector			PRLDNV50		
EEV Kit			PRGK024A0		
Independent Power Module			PRIPO		
Robot Cleaner			-		
Pre Filter (Washable)			○		
Ion Generator			○		
CO ₂ Sensor			-		
Ventilation Kit			-		
IR Receiver			-		
Zone Controller			-		
Dry Contact (with additional accessory)			PDRYCB000 (1 point contact), PDRYCB300 (8 points for thermostat compatible), PDRYCB320 (Universal input ¹⁾), PDRYCB400 (2 points input), PDRYCB500 (Modbus)		
External Input (1 point)			○		
Wi-Fi			○		

※ ○ : Applied, - : Not applied
Option : Refer to model name in table
1) Available from April 2020

ARTCOOL MIRROR

ARNU18GSKR4 / ARNU24GSKR4



Model	Unit	ARNU18GSKR4	ARNU24GSKR4
Cooling Capacity	kW	5.6	7.1
Heating Capacity	kW	6.3	7.5
Power Input (H / M / L)	Nominal W	32 / 26 / 16	39 / 26 / 16
Exterior Color		Mirror (Black)	Mirror (Black)
RAL Code		RAL 9005	RAL 9005
Dimensions (W x H x D)	Body mm	998 x 345 x 212	998 x 345 x 212
	Shipping mm	1,080 x 422 x 281	1,080 x 422 x 281
	Type	Cross Flow Fan	Cross Flow Fan
Fan	Motor Output x Number W x No.	58 x 1	58 x 1
	Air Flow Rate (H / M / L) m³/min	14.0 / 12.0 / 10.5	15.2 / 12.7 / 10.5
	Motor Type	BLDC	BLDC
Air Filter		Pre Filter	Pre Filter
Pipe Connections	Liquid Side mm (inch)	Ø6.35 (1/4)	Ø9.52 (3/8)
	Gas Side mm (inch)	Ø12.7 (1/2)	Ø15.88 (5/8)
	Drain Pipe (Internal Dia.) mm (inch)	Ø16 (5/8)	Ø16 (5/8)
Weight	Body kg	13.4	13.4
Sound Pressure Levels (H / M / L)	dB(A)	43 / 39 / 34	46 / 41 / 34
Sound Power Levels (H / M / L)	dB(A)	63 / 57 / 54	65 / 60 / 54
Power Supply	Ø, V, Hz	1, 220-240, 50	1, 220-240, 50
Communication Cable	mm² x No.	1.0 - 1.5 x 2C	1.0 - 1.5 x 2C

Note : 1. Performance tested under EN14511
2. Capacities are based on the following conditions
- Cooling : Indoor temp. 27°C (80.6°F) DB / 19°C (66.2°F) WB, Outdoor temp. 35°C (95°F) DB / 24°C (75.2°F) WB, Interconnecting piping length 7.5m, Level difference of zero
- Heating : Indoor temp. 20°C (68°F) DB / 15°C (59°F) WB, Outdoor temp. 7°C (44.6°F) DB / 6°C (42.8°F) WB, Interconnecting piping length 7.5m, Level difference of zero
3. Due to our policy of innovation, some specifications may be changed without notification

Accessories

Chassis	ARNU18GSKR4	ARNU24GSKR4
Drain Pump		-
Cassette Cover		-
Refrigerant Leakage Detector		PRLDNV50
EEV Kit		PRGK024A0
Independent Power Module		PRIPO
Robot Cleaner		-
Pre Filter (Washable)		○
Ion Generator		○
CO ₂ Sensor		-
Ventilation Kit		-
IR Receiver		-
Zone Controller		-
Dry Contact (with additional accessory)		PDRYCB000 (1 point contact), PDRYCB300 (8 points for thermostat compatible), PDRYCB320 (Universal input ¹⁾), PDRYCB400 (2 points input), PDRYCB500 (Modbus)
External Input (1 point)		○
Wi-Fi		○

※ ○ : Applied, - : Not applied
Option : Refer to model name in table
1) Available from April 2020

ARTCOOL GALLERY

ARNU07GSF14 / ARNU09GSF14
ARNU12GSF14



Model	Unit	ARNU07GSF14	ARNU09GSF14	ARNU12GSF14	
Cooling Capacity	kW	2.2	2.8	3.6	
Heating Capacity	kW	2.5	3.2	4.0	
Power Input (H / M / L)	Nominal W	28 / 16 / 10	28 / 16 / 10	32 / 20 / 12	
Dimensions (W x H x D)	Body	600 x 600 x 146	600 x 600 x 146	600 x 600 x 146	
	Shipping	685 x 670 x 215	685 x 670 x 215	685 x 670 x 215	
Fan	Type	Turbo Fan	Turbo Fan	Turbo Fan	
	Motor Output x Number	W x No.	30 x 1	30 x 1	
	Air Flow Rate (H / M / L)	m³/min	8.1 / 6.3 / 4.2	8.1 / 6.3 / 4.2	9.3 / 7.7 / 6.0
	Motor Type		BLDC	BLDC	
Air Filter		Pre Filter	Pre Filter	Pre Filter	
Pipe Connections	Liquid Side	mm (inch)	Ø6.35 (1/4)	Ø6.35 (1/4)	
	Gas Side	mm (inch)	Ø12.7 (1/2)	Ø12.7 (1/2)	
	Drain Pipe (Internal Dia.)	mm (inch)	Ø12 (15/32)	Ø12 (15/32)	
Weight	Body	kg	15.0	15.0	
Sound Pressure Levels (H / M / L)		dB(A)	38 / 32 / 27	38 / 32 / 27	44 / 38 / 32
Sound Power Levels (H / M / L)		dB(A)	48 / 46 / 41	48 / 46 / 41	54 / 46 / 38
Power Supply		Ø, V, Hz	1, 220-240, 50	1, 220-240, 50	1, 220-240, 50
Communication Cable		mm² x No.	1.0 ~ 1.5 x 2C	1.0 ~ 1.5 x 2C	1.0 ~ 1.5 x 2C

Note : 1. Performance tested under EN14511
 2. Capacities are based on the following conditions
 - Cooling : Indoor temp. 27°C (80.6°F) DB / 19°C (66.2°F) WB, Outdoor temp. 35°C (95°F) DB / 24°C (75.2°F) WB, Interconnecting piping length 7.5m, Level difference of zero
 - Heating : Indoor temp. 20°C (68°F) DB / 15°C (59°F) WB, Outdoor temp. 7°C (44.6°F) DB / 6°C (42.8°F) WB, Interconnecting piping length 7.5m, Level difference of zero
 3. Due to our policy of innovation, some specifications may be changed without notification

Accessories

Chassis	ARNU07GSF14	ARNU09GSF14	ARNU12GSF14
Drain Pump		-	
Cassette Cover		-	
Refrigerant Leakage Detector		PRLDNVSO	
EEV Kit		PRGK024A0	
Independent Power Module		PRIP0	
Robot Cleaner		-	
Pre Filter (Washable)		○	
Ion Generator		-	
CO ₂ Sensor		-	
Ventilation Kit		-	
IR Receiver		-	
Zone Controller		-	
Dry Contact (with additional accessory)		PDRYCB000 (1 point contact), PDRYCB300 (8 points for thermostat compatible), PDRYCB320 (Universal input ¹⁾), PDRYCB400 (2 points input), PDRYCB500 (Modbus)	
External Input (1 point)		○	
Wi-Fi		PWFMD200 ²⁾	

※ ○ : Applied, - : Not applied
 Option : Refer to model name in table
 1) Available from April 2020
 2) External installation only

STANDARD

ARNU05GSJ*4 / ARNU07GSJ*4
ARNU09GSJ*4 / ARNU12GSJ*4
ARNU15GSJ*4



Model	Unit	ARNU05GSJ*4	ARNU07GSJ*4	ARNU09GSJ*4	ARNU12GSJ*4	ARNU15GSJ*4	
Cooling Capacity	kW	1.6	2.2	2.8	3.6	4.5	
Heating Capacity	kW	1.8	2.5	3.2	4.0	5.0	
Power Input (H / M / L)	Nominal W	11 / 10 / 9	12 / 11 / 9	13 / 12 / 9	15 / 13 / 11	23 / 18 / 11	
Exterior Color		White	White	White	White	White	
RAL Code		RAL 9016	RAL 9016	RAL 9016	RAL 9016	RAL 9016	
Dimensions (W x H x D)	Body	mm	818 x 316 x 189	818 x 316 x 189	818 x 316 x 189	818 x 316 x 189	
	Shipping	mm	892 x 381 x 249	892 x 381 x 249	892 x 381 x 249	892 x 381 x 249	
Fan	Type		Cross Flow Fan	Cross Flow Fan	Cross Flow Fan	Cross Flow Fan	
	Motor Output x Number	W x No.	30 x 1	30 x 1	30 x 1	30 x 1	
	Air Flow Rate (H / M / L)	m³/min	6.8 / 6.5 / 5.9	7.2 / 6.8 / 5.9	7.8 / 7.2 / 5.9	8.5 / 7.8 / 6.8	10.5 / 9.5 / 6.8
	Motor Type		BLDC	BLDC	BLDC	BLDC	
Air Filter		Pre Filter	Pre Filter	Pre Filter	Pre Filter	Pre Filter	
Pipe Connections	Liquid Side	mm (inch)	Ø6.35 (1/4)	Ø6.35 (1/4)	Ø6.35 (1/4)	Ø6.35 (1/4)	
	Gas Side	mm (inch)	Ø12.7 (1/2)	Ø12.7 (1/2)	Ø12.7 (1/2)	Ø12.7 (1/2)	
	Drain Pipe (Internal Dia.)	mm (inch)	Ø16 (5/8)	Ø16 (5/8)	Ø16 (5/8)	Ø16 (5/8)	
Weight	Body	kg	8.4	8.4	8.4	8.4	
Sound Pressure Levels (H / M / L)		dB(A)	30 / 29 / 28	32 / 30 / 28	34 / 32 / 28	37 / 34 / 30	42 / 39 / 32
Sound Power Levels (H / M / L)		dB(A)	54 / 53 / 52	54 / 53 / 52	55 / 54 / 52	55 / 54 / 53	58 / 56 / 54
Power Supply		Ø, V, Hz	1, 220-240, 50	1, 220-240, 50	1, 220-240, 50	1, 220-240, 50	
Communication Cable		mm² x No.	1.0 ~ 1.5 x 2C	1.0 ~ 1.5 x 2C	1.0 ~ 1.5 x 2C	1.0 ~ 1.5 x 2C	

*: N or C can be applied which has little bit different shape of panel.
 Note : 1. Performance tested under EN14511
 2. Capacities are based on the following conditions
 - Cooling : Indoor temp. 27°C (80.6°F) DB / 19°C (66.2°F) WB, Outdoor temp. 35°C (95°F) DB / 24°C (75.2°F) WB, Interconnecting piping length 7.5m, Level difference of zero
 - Heating : Indoor temp. 20°C (68°F) DB / 15°C (59°F) WB, Outdoor temp. 7°C (44.6°F) DB / 6°C (42.8°F) WB, Interconnecting piping length 7.5m, Level difference of zero
 3. Due to our policy of innovation, some specifications may be changed without notification

Accessories

Chassis	ARNU05GSJ*4	ARNU07GSJ*4	ARNU09GSJ*4	ARNU12GSJ*4	ARNU15GSJ*4
Drain Pump					
Cassette Cover					
Refrigerant Leakage Detector			PRLDNVSO		
EEV Kit			PRGK024A0		
Independent Power Module			PRIP0		
Robot Cleaner			-		
Pre Filter (Washable)			○		
Ion Generator			○		
CO ₂ Sensor			-		
Ventilation Kit			-		
IR Receiver			-		
Zone Controller			-		
Dry Contact (with additional accessory)		PDRYCB000 (1 point contact), PDRYCB300 (8 points for thermostat compatible), PDRYCB320 (Universal input ¹⁾), PDRYCB400 (2 points input), PDRYCB500 (Modbus)			
External Input (1 point)		○			
Wi-Fi			○		

※ ○ : Applied, - : Not applied
 Option : Refer to model name in table
 1) Available from April 2020

STANDARD

ARNU18GSK*4 / ARNU24GSK*4



Model	Unit	ARNU18GSK*4	ARNU24GSK*4
Cooling Capacity	kW	5.6	7.1
Heating Capacity	kW	6.3	7.5
Power Input (H / M / L)	Nominal W	32 / 26 / 16	39 / 26 / 16
Exterior Color		White	White
RAL Code		RAL 9016	RAL 9016
Dimensions (W x H x D)	Body	mm	975 x 354 x 209
	Shipping	mm	1,063 x 420 x 274
	Type		Cross Flow Fan
Fan	Motor Output x Number	W x No.	58 x 1
	Air Flow Rate (H / M / L)	m³/min	14.0 / 12.0 / 10.5
	Motor Type		BLDC
Air Filter		Pre Filter	Pre Filter
Pipe Connections	Liquid Side	mm (inch)	Ø6.35 (1/4)
	Gas Side	mm (inch)	Ø12.7 (1/2)
	Drain Pipe (Internal Dia.)	mm (inch)	Ø16 (5/8)
Weight	Body kg	12.2	12.2
Sound Pressure Levels (H / M / L)	dB(A)	43 / 39 / 34	46 / 41 / 34
Sound Power Levels (H / M / L)	dB(A)	63 / 57 / 54	65 / 60 / 54
Power Supply	Ø, V, Hz	1, 220-240, 50	1, 220-240, 50
Communication Cable	mm² x No.	1.0 ~ 1.5 x 2C	1.0 ~ 1.5 x 2C

* : N or C can be applied which has little bit different shape of panel.

Note : 1. Performance tested under EN14511

2. Capacities are based on the following conditions

- Cooling : Indoor temp. 27°C (80.6°F) DB / 19°C (66.2°F) WB, Outdoor temp. 35°C (95°F) DB / 24°C (75.2°F) WB, Interconnecting piping length 7.5m, Level difference of zero

- Heating : Indoor temp. 20°C (68°F) DB / 15°C (59°F) WB, Outdoor temp. 7°C (44.6°F) DB / 6°C (42.8°F) WB, Interconnecting piping length 7.5m, Level difference of zero

3. Due to our policy of innovation, some specifications may be changed without notification

Accessories

Chassis	ARNU18GSK*4	ARNU24GSK*4
Drain Pump	-	-
Cassette Cover	-	-
Refrigerant Leakage Detector		PRLDNV50
EEV Kit		PRGK024A0
Independent Power Module		PRIPO
Robot Cleaner	-	-
Pre Filter (Washable)		○
Ion Generator		○
CO ₂ Sensor	-	-
Ventilation Kit	-	-
IR Receiver	-	-
Zone Controller	-	-
Dry Contact (with additional accessory)		PDRYCB000 (1 point contact), PDRYCB300 (8 points for thermostat compatible), PDRYCB320 (Universal input ¹⁾), PDRYCB400 (2 points input), PDRYCB500 (Modbus)
External Input (1 point)		○
Wi-Fi		○

※ ○ : Applied, - : Not applied

Option : Refer to model name in table

1) Available from April 2020

STANDARD

ARNU30GSVA4 / ARNU36GSVA4



Model	Unit	ARNU30GSVA4	ARNU36GSVA4
Cooling Capacity	kW	8.8	10.4
Heating Capacity	kW	9.4	10.8
Power Input (H / M / L)	Nominal W	54 / 43 / 31	85 / 51 / 36
Exterior Color		White	White
RAL Code		RAL 9016	RAL 9016
Dimensions (W x H x D)	Body	mm	1,190 x 346 x 265
	Shipping	mm	1,265 x 432 x 335
	Type		Cross Flow Fan
Fan	Motor Output x Number	W x No.	113 x 1
	Air Flow Rate (H / M / L)	m³/min	23.0 / 20.0 / 17.0
	Motor Type		BLDC
Air Filter		Pre Filter	Pre Filter
Pipe Connections	Liquid Side	mm (inch)	Ø9.52 (3/8)
	Gas Side	mm (inch)	Ø15.88 (5/8)
	Drain Pipe (Internal Dia.)	mm (inch)	Ø16 (5/8)
Weight	Body kg	16.6	16.6
Sound Pressure Levels (H / M / L)	dB(A)	49 / 44 / 42	52 / 47 / 43
Power Supply	Ø, V, Hz	1, 220-240, 50	1, 220-240, 50
Communication Cable	mm² x No.	1.0 ~ 1.5 x 2C	1.0 ~ 1.5 x 2C

Note : 1. Performance tested under EN14511

2. Capacities are based on the following conditions

- Cooling : Indoor temp. 27°C (80.6°F) DB / 19°C (66.2°F) WB, Outdoor temp. 35°C (95°F) DB / 24°C (75.2°F) WB, Interconnecting piping length 7.5m, Level difference of zero

- Heating : Indoor temp. 20°C (68°F) DB / 15°C (59°F) WB, Outdoor temp. 7°C (44.6°F) DB / 6°C (42.8°F) WB, Interconnecting piping length 7.5m, Level difference of zero

3. Due to our policy of innovation, some specifications may be changed without notification

Accessories

Chassis	ARNU30GSVA4	ARNU36GSVA4
Drain Pump	-	-
Cassette Cover	-	-
Refrigerant Leakage Detector		PRLDNV50
EEV Kit		-
Independent Power Module		PRIPO
Robot Cleaner	-	-
Pre Filter (Washable)		○
Ion Generator		-
CO ₂ Sensor	-	-
Ventilation Kit	-	-
IR Receiver	-	-
Zone Controller	-	-
Dry Contact (with additional accessory)		PDRYCB000 (1 point contact), PDRYCB300 (8 points for thermostat compatible), PDRYCB320 (Universal input ¹⁾), PDRYCB400 (2 points input), PDRYCB500 (Modbus)
External Input (1 point)		○
Wi-Fi		PWFMD200 ²⁾

※ ○ : Applied, - : Not applied

Option : Refer to model name in table

1) Available from April 2020

2) External installation only

CEILING MOUNTED CASSETTE



Features & Benefits

- New dual vane 4 way cassette allows comfortable air flow
- Full 3D Turbo fan decreases air resistance, providing high air flow and low sound levels.

Key Applications

- Retail
- School
- Office
- Hotel
- Dormitory
- Restaurant

	Cassette	4 Way	2 Way	1 Way
Smart	Wi-Fi	○	○	○
Energy Efficiency	Human Detect Sensor	○	-	-
	Drain Pump	○	○	○
	Sleep Mode	○	○	○
Comfort	Timer (On / Off)	○	○	○
	Timer (Weekly)	○	○	○
	Two Thermistor Control	○	○	○
	Group Control	○	○	○

NEW DESIGN

4 Way Air Flow with New Design

New Excellent Technology (NET) certifies new 4 way dual vane design that promotes comfortable and convenient airflow.



*New types wind

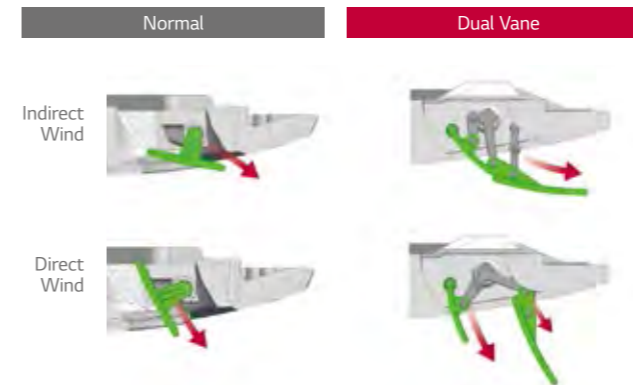

*6 Airflows mode



Brighter Color

Color enhancement allows cassette to blend in to most interior ceiling spaces.

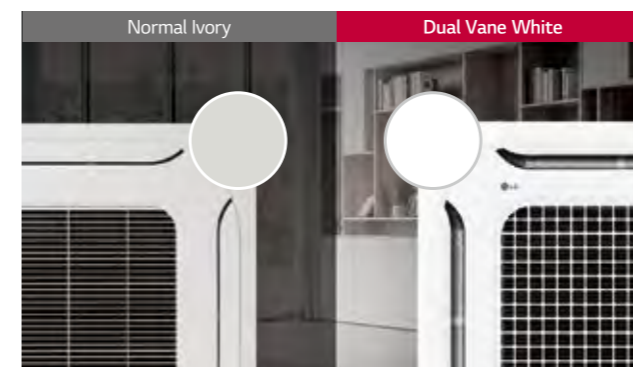

Wide Design

Bigger inlet and outlet make faster cooling / heating airflow.

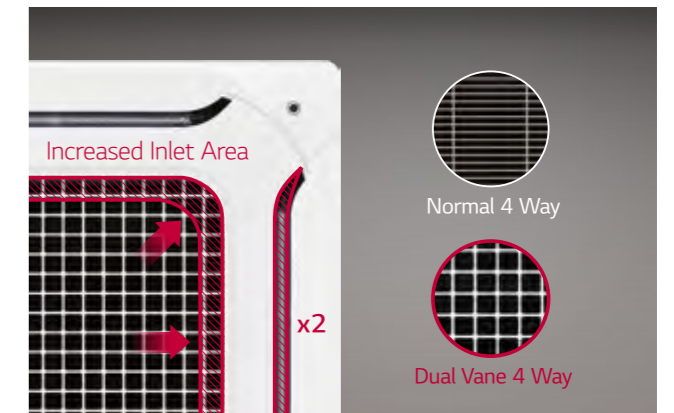

Full 3D Turbo Fan

Full 3D Turbo fan decreases air resistance, so it makes High Efficient and reduces noise level.



High Efficiency Heat Exchanger (HEX)

Ø5 High Density Heat Exchanger increases cooling / heating efficiency by 10%.

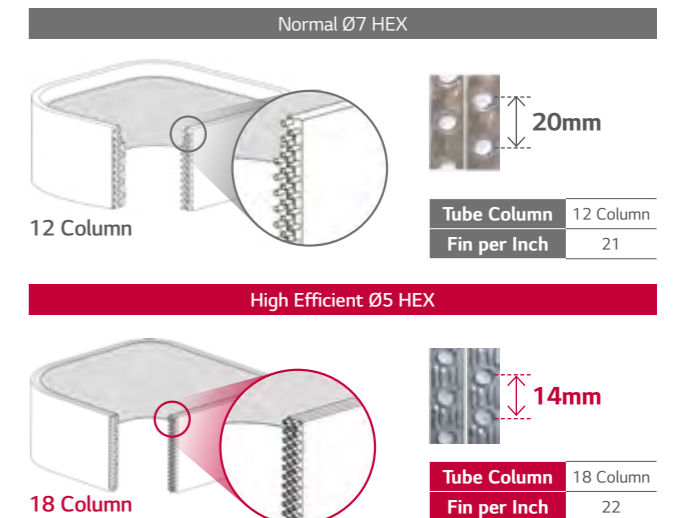

SMART

Ceiling to Floor Temperature Sensing

With a special sensor that sense both ceiling and floor temperature, dual vane 4 way cassette provides comfort air.

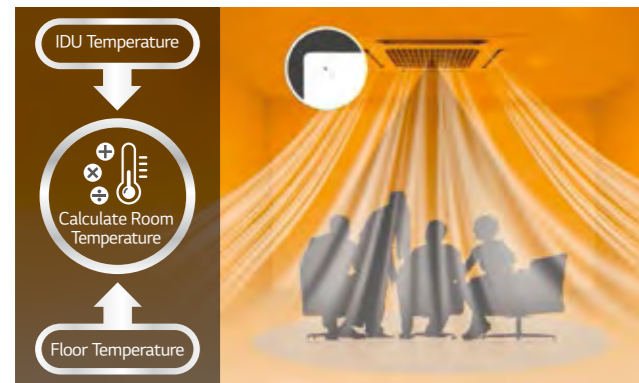

※ Available only for products with floor temperature sensor.

Human-detection Air Flow

Human detection provides users with direct or indirect air flow preferences.

Indirect comfort

Provides air flow that blows away from user for comfort.



No touch Indirect airflow Comfort

Direct cooling

Provides air flow that blows directly onto user for cooling.

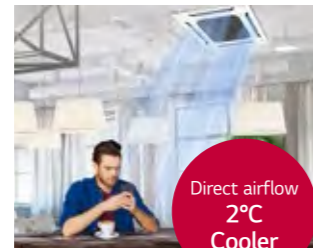

Direct airflow 2°C Cooler

Human Detection for Optimized Efficiency

Indoor unit senses human presence to switch on or off for maximum power savings of 54%.

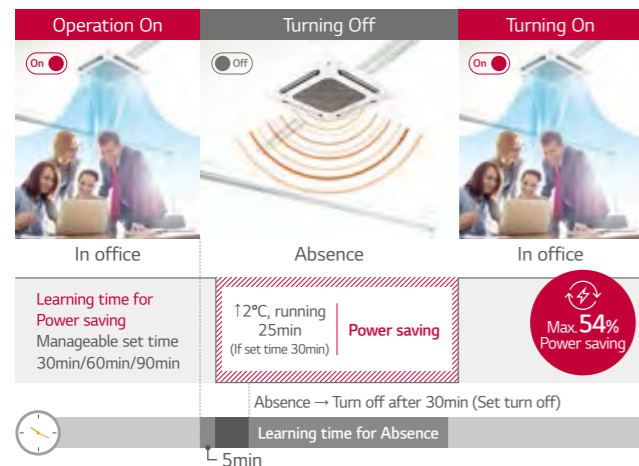

※ Smart Dual Vane Indoor Unit '19 Line up.
 ※ Data Based on actual test of LG, single product 2 hours measurement result. (Cooling 26 °C, strong wind)

High-performance Air Cleaning

Air cleaning function provides fresh, filtered air.



Convenient & Powerful 4-Step Air Cleaning

Easy-to-manage air cleaning system with one-touch air cleaning filter.



Cycle Management

Pre-filter	Dust Electrification	Ultra Fine Dust Kit	Deodorizing Filter
Easy removable pre-filter	-	6 months / Washable	6 months / Dry

SMART

Air Cleaning Status Display

Wi-Fi functionality for anytime, anywhere indoor unit control and air cleaning status display.

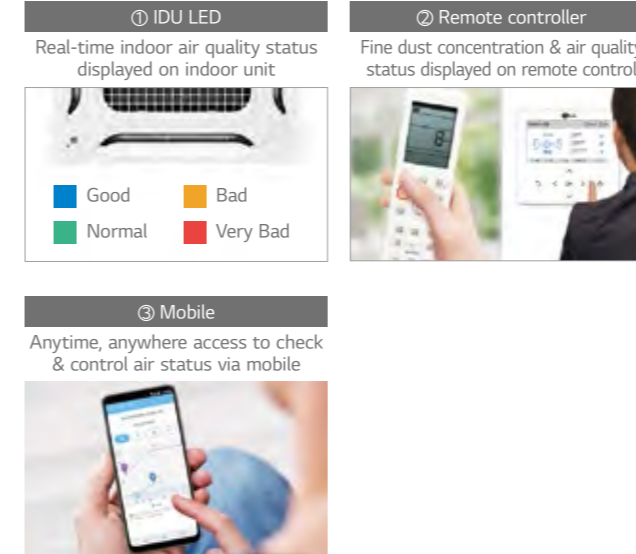

Dual Elevating Grille

Grille automatically detaches and re-attaches with 4 touchpoints for enhanced stability & convenient filter management.

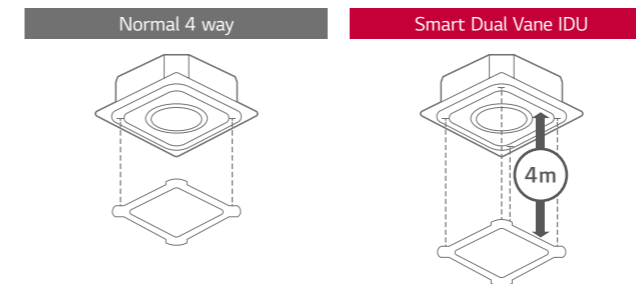

① Horizontal Sensor ② Check Close grille ③ Detect Obstacle ④ Set Stop Point
 ① Horizontal Sensor ② Check Close grille

LG ThinQ Connectivity

Anytime anywhere access to indoor units with LG ThinQ mobile app.

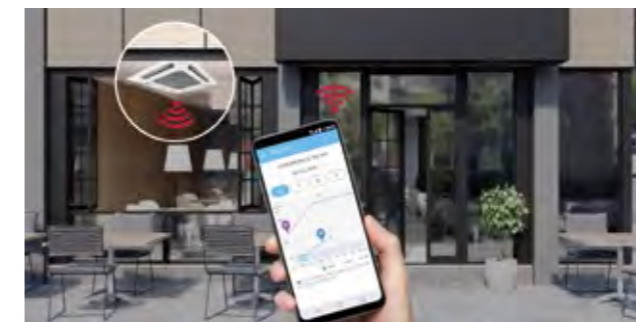

- ① Monitoring Air status
 - Easy to check indoor air status
 - Ultra Fine / Extra Fine / Fine Dust
 - Day / Week / Month / Yearly
- ② Mobile Remote Control
 - Remote control by using mobile phone
 - Control Mode / Temperature / Air flow etc.
- ③ Display Power Consumption
 - Check power consumption of A/C
 - Check energy display
 - Set target energy consumption level

INSTALLATION

Minimized Height

With a height of 132mm, the LG 1 Way cassette is the ideal solution for limited-space installations.

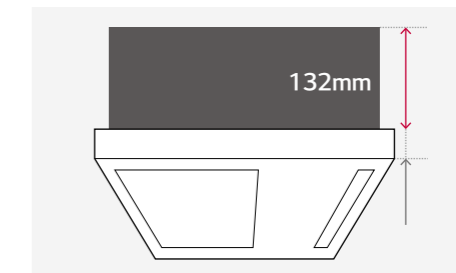

Size Comparison (Unit : mm)

	A Company	B Company	LG
1 Way Cassette	215	230	132

Flexible Installation

1 Way cassette doesn't require the inspection access hole, so that simple installation is possible.

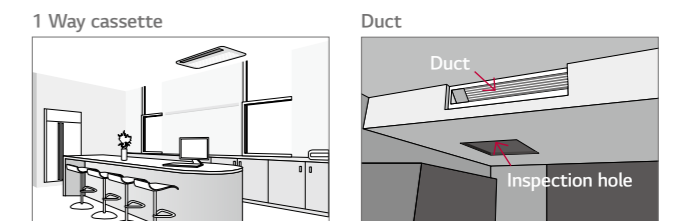

Installation Standard

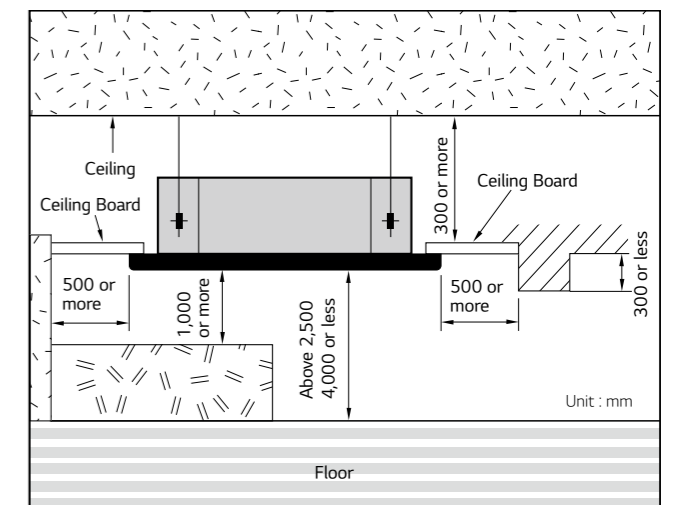

DUAL VANE 4 WAY CASSETTE

(840 X 840)

ARNU24GTBB4 / ARNU28GTBB4
ARNU30GTBB4

Available from **JUNE 2020**



Model	Unit	ARNU24GTBB4	ARNU28GTBB4	ARNU30GTBB4
Cooling Capacity	kW	7.1	8.2	9.0
Heating Capacity	kW	8.0	9.2	10.0
Power Input (H / M / L)	Nominal W	32 / 27 / 20	37 / 30 / 22	48 / 36 / 25
Dimensions (W x H x D)	Body	840 x 204 x 840	840 x 204 x 840	840 x 204 x 840
	Shipping	922 x 276 x 917	922 x 276 x 917	922 x 276 x 917
Fan	Type	Full 3D Turbo Fan	Full 3D Turbo Fan	Full 3D Turbo Fan
	Motor Output x Number	W 51 x 1	51 x 1	51 x 1
	Air Flow Rate (H / M / L)	m³/min 18 / 17 / 15	19 / 17 / 15	21 / 19 / 16
	Motor Type	BLDC	BLDC	BLDC
Air Filter		Pre Filter	Pre Filter	Pre Filter
Pipe Connections	Liquid Side	mm (inch) Ø9.52 (3/8)	Ø9.52 (3/8)	Ø9.52 (3/8)
	Gas Side	mm (inch) Ø15.88 (5/8)	Ø15.88 (5/8)	Ø15.88 (5/8)
	Drain Pipe (Internal Dia.)	mm (inch) Ø25 (1)	Ø25 (1)	Ø25 (1)
Weight	Body kg	21	21	21
Sound Pressure Level (H / M / L)	dB(A)	36 / 34 / 31	39 / 35 / 34	40 / 36 / 33
Sound Power Level (H / M / L)	dB(A)	46 / 44 / 42	50 / 46 / 43	53 / 50 / 45
Power Supply	Ø, V, Hz	1, 220-240, 50	1, 220-240, 50	1, 220-240, 50
Communication Cable	mm² x No.	1.25 x 2C	1.25 x 2C	1.25 x 2C
Decoration Panel (Accessory)	Model Name	PT-AAGW0 PT-AFGW0 PT-AEGW0	PT-AAGW0 PT-AFGW0 PT-AEGW0	PT-AAGW0 PT-AFGW0 PT-AEGW0
	Exterior Color	White	White	White
	RAL Code	RAL 9003	RAL 9003	RAL 9003
	Net Dimensions (W x H x D)	mm 950 x 35 x 950	950 x 35 x 950	950 x 35 x 950
	Net Weight	kg 7.1 / 7.5 / 8.5	7.1 / 7.5 / 8.5	7.1 / 7.5 / 8.5

Note : 1. Performance tested under EN14511
2. Capacities are based on the following conditions
- Cooling : Indoor temp. 27°C (80.6°F) DB / 19°C (66.2°F) WB, Outdoor temp. 35°C (95°F) DB / 24°C (75.2°F) WB, Interconnecting piping length 7.5m, Level difference of zero
- Heating : Indoor temp. 20°C (68°F) DB / 15°C (59°F) WB, Outdoor temp. 7°C (44.6°F) DB / 6°C (42.8°F) WB, Interconnecting piping length 7.5m, Level difference of zero
3. Due to our policy of innovation, some specifications may be changed without notification

Accessories

Chassis	ARNU24GTBB4	ARNU28GTBB4	ARNU30GTBB4
Drain Pump		○	
Cassette Cover		PTDCA	
Refrigerant Leakage Detector		PRLDNVSO	
EEV Kit		-	
Independent Power Module		PRIPO	
Robot Cleaner		-	
Pre Filter (Washable)		○	
Ion Generator		-	
CO ₂ Sensor		-	
Ventilation Kit		-	
IR Receiver		-	
Zone Controller		-	
Dry Contact (with additional accessory)	PDRYCB000 (1 point contact), PDRYCB300 (8 points for thermostat compatible), PDRYCB320 (Universal input ¹⁾), PDRYCB400 (2 points input), PDRYCB500 (Modbus)		
External Input (1 Point)		○	
Wi-Fi		PWFMD200	
Human detection sensor		PTVSAAO	
Floor Temperature Sensor		PT-AFGW0 :○	
Air cleaning kit		PT-AFGW0 : PTAFMPO	
Elevation Grille		PT-AEGW0 :○	

1) Available from April 2020

DUAL VANE 4 WAY CASSETTE

(840 X 840)

ARNU36GTAB4 / ARNU42GTAB4
ARNU48GTAB4

Available from **JUNE 2020**



Model	Unit	ARNU36GTAB4	ARNU42GTAB4	ARNU48GTAB4
Cooling Capacity	kW	10.6	12.3	14.1
Heating Capacity	kW	11.9	13.8	15.9
Power Input (H / M / L)	Nominal W	69 / 49 / 37	97 / 69 / 49	110 / 76 / 61
Dimensions (W x H x D)	Body	840 x 288 x 840	840 x 288 x 840	840 x 288 x 840
	Shipping	922 x 360 x 917	922 x 360 x 917	922 x 360 x 917
Fan	Type	Full 3D Turbo Fan	Full 3D Turbo Fan	Full 3D Turbo Fan
	Motor Output x Number	W 135 x 1	135 x 1	135 x 1
	Air Flow Rate (H / M / L)	m³/min 29 / 26 / 22	33 / 29 / 26	34 / 30 / 28
	Motor Type	BLDC	BLDC	BLDC
Air Filter		Pre Filter	Pre Filter	Pre Filter
Pipe Connections	Liquid Side	mm (inch) Ø9.52 (3/8)	Ø9.52 (3/8)	Ø9.52 (3/8)
	Gas Side	mm (inch) Ø15.88 (5/8)	Ø15.88 (5/8)	Ø15.88 (5/8)
	Drain Pipe (Internal Dia.)	mm (inch) Ø25 (1)	Ø25 (1)	Ø25 (1)
Weight	Body kg	26	26	26
Sound Pressure Level (H / M / L)	dB(A)	42 / 39 / 36	44 / 41 / 39	46 / 43 / 41
Sound Power Level (H / M / L)	dB(A)	54 / 51 / 47	56 / 53 / 49	58 / 54 / 53
Power Supply	Ø, V, Hz	1, 220-240, 50	1, 220-240, 50	1, 220-240, 50
Communication Cable	mm² x No.	1.25 x 2C	1.25 x 2C	1.25 x 2C
Decoration Panel (Accessory)	Model Name	PT-AAGW0 PT-AFGW0 PT-AEGW0	PT-AAGW0 PT-AFGW0 PT-AEGW0	PT-AAGW0 PT-AFGW0 PT-AEGW0
	Exterior Color	White	White	White
	RAL Code	RAL 9003	RAL 9003	RAL 9003
	Net Dimensions (W x H x D)	mm 950 x 35 x 950	950 x 35 x 950	950 x 35 x 950
	Net Weight	kg 7.1 / 7.5 / 8.5	7.1 / 7.5 / 8.5	7.1 / 7.5 / 8.5

Note : 1. Performance tested under EN14511
2. Capacities are based on the following conditions
- Cooling : Indoor temp. 27°C (80.6°F) DB / 19°C (66.2°F) WB, Outdoor temp. 35°C (95°F) DB / 24°C (75.2°F) WB, Interconnecting piping length 7.5m, Level difference of zero
- Heating : Indoor temp. 20°C (68°F) DB / 15°C (59°F) WB, Outdoor temp. 7°C (44.6°F) DB / 6°C (42.8°F) WB, Interconnecting piping length 7.5m, Level difference of zero
3. Due to our policy of innovation, some specifications may be changed without notification

Accessories

Chassis	ARNU36GTAB4	ARNU42GTAB4	ARNU48GTAB4
Drain Pump		○	
Cassette Cover		PTDCA	
Refrigerant Leakage Detector		PRLDNVSO	
EEV Kit		-	
Independent Power Module		PRIPO	
Robot Cleaner		-	
Pre Filter (Washable)		○	
Ion Generator		-	
CO ₂ Sensor		-	
Ventilation Kit		-	
IR Receiver		-	
Zone Controller		-	
Dry Contact (with additional accessory)	PDRYCB000 (1 point contact), PDRYCB300 (8 points for thermostat compatible), PDRYCB320 (Universal input ¹⁾), PDRYCB400 (2 points input), PDRYCB500 (Modbus)		
External Input (1 Point)		○	
Wi-Fi		PWFMD200	
Human detection sensor		PTVSAAO	
Floor Temperature Sensor		PT-AFGW0 :○	
Air cleaning kit		PT-AFGW0 : PTAFMPO	
Elevation Grille		PT-AEGW0 :○	

1) Available from April 2020

DUAL VANE 4 WAY CASSETTE

(840 X 840) HIGH SENSIBLE

ARNU07GTAA4 / ARNU09GTAA4
ARNU12GTAA4 / ARNU15GTAA4
ARNU18GTAA4

Available from **JUNE 2020**



Model	Unit	ARNU07GTAA4	ARNU09GTAA4	ARNU12GTAA4	ARNU15GTAA4	ARNU18GTAA4
Cooling Capacity	kW	2.2	2.8	3.6	4.5	5.6
Heating Capacity	kW	2.5	3.2	4.0	5.0	6.3
Power Input (H / M / L)	Nominal W	23 / 16 / 11	25 / 18 / 11	26 / 19 / 13	29 / 20 / 15	31 / 23 / 16
Dimensions (W x H x D)	Body	840 x 288 x 840	840 x 288 x 840	840 x 288 x 840	840 x 288 x 840	840 x 288 x 840
	Shipping	922 x 360 x 917	922 x 360 x 917	922 x 360 x 917	922 x 360 x 917	922 x 360 x 917
Fan	Type	Full 3D Turbo Fan	Full 3D Turbo Fan	Full 3D Turbo Fan	Full 3D Turbo Fan	Full 3D Turbo Fan
	Motor Output x Number	W 166x1	166 x 1	166x1	166 x 1	166x1
	Running Cuurent	A 0.23	0.25	0.25	0.27	0.28
	Air Flow Rate (H / M / L)	m³/min 19 / 16 / 13	19 / 16 / 13	20 / 17 / 15	20 / 17 / 15	21 / 19 / 16
	Motor Type	BLDC	BLDC	BLDC	BLDC	BLDC
Air Filter		Pre Filter	Pre Filter	Pre Filter	Pre Filter	Pre Filter
Pipe Connections	Liquid Side	mm (inch) Ø9.52 (3/8)	Ø9.52 (3/8)	Ø9.52 (3/8)	Ø9.52 (3/8)	Ø9.52 (3/8)
	Gas Side	mm (inch) Ø15.88 (5/8)	Ø15.88 (5/8)	Ø15.88 (5/8)	Ø15.88 (5/8)	Ø15.88 (5/8)
	Drain Pipe (Internal Dia.)	mm (inch) Ø25 (1)	Ø25 (1)	Ø25 (1)	Ø25 (1)	Ø25 (1)
Weight	Body	kg 26	26	26	26	26
Sound Pressure Level (H / M / L)	dB(A)	32 / 30 / 26	33 / 30 / 26	34 / 31 / 27	34 / 32 / 29	35 / 32 / 30
Sound Power Level (H / M / L)	dB(A)	41 / 38 / 34	42 / 39 / 34	42 / 40 / 36	43 / 40 / 37	44 / 41 / 38
Power Supply	Ø, V, Hz	1, 220-240, 50	1, 220-240, 50	1, 220-240, 50	1, 220-240, 50	1, 220-240, 50
Communication Cable	mm² x No.	1.25 x 2C	1.25 x 2C	1.25 x 2C	1.25 x 2C	1.25 x 2C
Decoration Panel (Accessory)	Exterior Color	White	White	White	White	White
	RAL Code	RAL 9003	RAL 9003	RAL 9003	RAL 9003	RAL 9003
	Net Dimensions (W x H x D)	mm 950 x 35 x 950	950 x 35 x 950	950 x 35 x 950	950 x 35 x 950	950 x 35 x 950
	Net Weight	kg 7.1 / 7.5 / 8.5	7.1 / 7.5 / 8.5	7.1 / 7.5 / 8.5	7.1 / 7.5 / 8.5	7.1 / 7.5 / 8.5

Note : 1. Performance tested under EN14511
2. Capacities are based on the following conditions
- Cooling : Indoor temp. 27°C (80.6°F) DB / 19°C (66.2°F) WB, Outdoor temp. 35°C (95°F) DB / 24°C (75.2°F) WB, Interconnecting piping length 7.5m, Level difference of zero
- Heating : Indoor temp. 20°C (68°F) DB / 15°C (59°F) WB, Outdoor temp. 7°C (44.6°F) DB / 6°C (42.8°F) WB, Interconnecting piping length 7.5m, Level difference of zero
3. Due to our policy of innovation, some specifications may be changed without notification

Accessories

Chassis	ARNU07GTAA4	ARNU09GTAA4	ARNU12GTAA4	ARNU15GTAA4	ARNU18GTAA4
Drain Pump			○		
Cassette Cover			PTDCA		
Refrigerant Leakage Detector			PRLDNVSO		
EEV Kit			-		
Independent Power Module			PRIPO		
Robot Cleaner			-		
Pre Filter (Washable)			○		
Ion Generator			-		
CO ₂ Sensor			-		
Ventilation Kit			-		
IR Receiver			-		
Zone Controller			-		
Dry Contact (with additional accessory)		PDRYCB000 (1 point contact), PDRYCB300 (8 points for thermostat compatible), PDRYCB320 (Universal input ¹⁾), PDRYCB400 (2 points input), PDRYCB500 (Modbus)			
External Input (1 Point)			○		
Wi-Fi			PWFMD200		
Human detection sensor			PTVSAAO		
Floor Temperature Sensor			PT-AFGW0 : ○		
Air cleaning kit			PT-AFGW0 : PTAFMPO		
Elevation Grille			PT-AEGW0 : ○		

1) Available from April 2020

DUAL VANE 4WAY CASSETTE

(840 X 840) HIGH SENSIBLE

ARNU24GTAA4 / ARNU28GTAA4
ARNU36GTAA4 / ARNU42GTAA4
ARNU48GTAA4

Available from **JUNE 2020**



Model	Unit	ARNU24GTAA4	ARNU28GTAA4	ARNU36GTAA4	ARNU42GTAA4	ARNU48GTAA4
Cooling Capacity	kW	7.1	8.2	10.6	12.3	14.1
Heating Capacity	kW	8.0	9.2	11.9	13.8	15.9
Power Input (H / M / L)	Nominal W	35 / 29 / 20	40 / 31 / 25	65 / 43 / 31	86 / 65 / 43	100 / 67 / 53
Dimensions (W x H x D)	Body	840 x 288 x 840	840 x 288 x 840	840 x 288 x 840	840 x 288 x 840	840 x 288 x 840
	Shipping	922 x 360 x 917	922 x 360 x 917	922 x 360 x 917	922 x 360 x 917	922 x 360 x 917
Fan	Type	Full 3D Turbo Fan	Full 3D Turbo Fan	Full 3D Turbo Fan	Full 3D Turbo Fan	Full 3D Turbo Fan
	Motor Output x Number	W 166x1	166 x 1	166x1	166 x 1	166x1
	Running Cuurent	A 0.38	0.46	0.60	0.80	0.88
	Air Flow Rate (H / M / L)	m³/min 23 / 21 / 19	24 / 22 / 20	28 / 24 / 21	31 / 28 / 24	33 / 28 / 26
	Motor Type	BLDC	BLDC	BLDC	BLDC	BLDC
Air Filter		Pre Filter	Pre Filter	Pre Filter	Pre Filter	Pre Filter
Pipe Connections	Liquid Side	mm (inch) Ø9.52 (3/8)	Ø9.52 (3/8)	Ø9.52 (3/8)	Ø9.52 (3/8)	Ø9.52 (3/8)
	Gas Side	mm (inch) Ø15.88 (5/8)	Ø15.88 (5/8)	Ø15.88 (5/8)	Ø15.88 (5/8)	Ø15.88 (5/8)
	Drain Pipe (Internal Dia.)	mm (inch) Ø25 (1)	Ø25 (1)	Ø25 (1)	Ø25 (1)	Ø25 (1)
Weight	Body	kg 26	26	26	26	26
Sound Pressure Level (H / M / L)	dB(A)	39 / 36 / 33	40 / 37 / 34	42 / 39 / 35	46 / 42 / 39	47 / 43 / 41
Sound Power Level (H / M / L)	dB(A)	47 / 45 / 42	48 / 46 / 42	51 / 48 / 44	54 / 51 / 48	56 / 52 / 50
Power Supply	Ø, V, Hz	1, 220-240, 50	1, 220-240, 50	1, 220-240, 50	1, 220-240, 50	1, 220-240, 50
Communication Cable	mm² x No.	1.25 x 2C	1.25 x 2C	1.25 x 2C	1.25 x 2C	1.25 x 2C
Decoration Panel (Accessory)	Model Name	PT-AAGW0 PT-AFGW0 PT-AEGW0	PT-AAGW0 PT-AFGW0 PT-AEGW0	PT-AAGW0 PT-AFGW0 PT-AEGW0	PT-AAGW0 PT-AFGW0 PT-AEGW0	PT-AAGW0 PT-AFGW0 PT-AEGW0
	Exterior Color	White	White	White	White	White
	RAL Code	RAL 9003	RAL 9003	RAL 9003	RAL 9003	RAL 9003
	Net Dimensions (W x H x D)	mm 950 x 35 x 950	950 x 35 x 950	950 x 35 x 950	950 x 35 x 950	950 x 35 x 950
Net Weight	kg 7.1 / 7.5 / 8.5	7.1 / 7.5 / 8.5	7.1 / 7.5 / 8.5	7.1 / 7.5 / 8.5	7.1 / 7.5 / 8.5	

Note : 1. Performance tested under EN14511
2. Capacities are based on the following conditions
- Cooling : Indoor temp. 27°C (80.6°F) DB / 19°C (66.2°F) WB, Outdoor temp. 35°C (95°F) DB / 24°C (75.2°F) WB, Interconnecting piping length 7.5m, Level difference of zero
- Heating : Indoor temp. 20°C (68°F) DB / 15°C (59°F) WB, Outdoor temp. 7°C (44.6°F) DB / 6°C (42.8°F) WB, Interconnecting piping length 7.5m, Level difference of zero
3. Due to our policy of innovation, some specifications may be changed without notification

Accessories

Chassis	ARNU24GTAA4	ARNU28GTAA4	ARNU36GTAA4	ARNU42GTAA4	ARNU48GTAA4
Drain Pump			○		
Cassette Cover			PTDCA		
Refrigerant Leakage Detector			PRLDNVSO		
EEV Kit			-		
Independent Power Module			PRIPO		
Robot Cleaner			-		
Pre Filter (Washable)			○		
Ion Generator			-		
CO ₂ Sensor			-		
Ventilation Kit			-		
IR Receiver			-		
Zone Controller			-		
Dry Contact (with additional accessory)		PDRYCB000 (1 point contact), PDRYCB300 (8 points for thermostat compatible), PDRYCB320 (Universal input ¹⁾), PDRYCB400 (2 points input), PDRYCB500 (Modbus)			
External Input (1 Point)			○		
Wi-Fi			PWFMD200		
Human detection sensor			PTVSAAO		
Floor Temperature Sensor			PT-AFGW0 : ○		
Air cleaning kit			PT-AFGW0 : PTAFMPO		
Elevation Grille			PT-AEGW0 : ○		

1) Available from April 2020

4 WAY CASSETTE (570 X 570)

ARNU05GTRB4 / ARNU07GTRB4
ARNU09GTRB4 / ARNU12GTRB4



Model	Unit	ARNU05GTRB4	ARNU07GTRB4	ARNU09GTRB4	ARNU12GTRB4
Cooling Capacity	kW	1.6	2.2	2.8	3.6
Heating Capacity	kW	1.8	2.5	3.2	4.0
Power Input (H / M / L)	Nominal	W	13 / 12 / 11	13 / 12 / 11	14 / 13 / 12
Dimensions (W x H x D)	Body	mm	570 x 214 x 570	570 x 214 x 570	570 x 214 x 570
	Shipping	mm	667 x 285 x 646	667 x 285 x 646	667 x 285 x 646
Fan	Type		Turbo Fan	Turbo Fan	Turbo Fan
	Motor Output x Number	W	43 x 1	43 x 1	43 x 1
	Air Flow Rate (H / M / L)	m ³ /min	7.5 / 7.0 / 6.6	7.5 / 7.0 / 6.6	8.0 / 7.5 / 7.1
	Motor Type		BLDC	BLDC	BLDC
Air Filter		Pre Filter	Pre Filter	Pre Filter	Pre Filter
Pipe Connections	Liquid Side	mm (inch)	Ø6.35 (1/4)	Ø6.35 (1/4)	Ø6.35 (1/4)
	Gas Side	mm (inch)	Ø12.7 (1/2)	Ø12.7 (1/2)	Ø12.7 (1/2)
	Drain Pipe (Internal Dia.)	mm (inch)	Ø25 (1)	Ø25 (1)	Ø25 (1)
Weight	Body	kg	12.6	12.6	13.7
Sound Pressure Levels (H / M / L)		dB(A)	29 / 27 / 26	29 / 27 / 26	30 / 29 / 27
Sound Power Levels (H / M / L)		dB(A)	45 / 43 / 42	45 / 43 / 42	46 / 43 / 42
Power Supply		Ø, V, Hz	1,220-240, 50	1,220-240, 50	1,220-240, 50
Communication Cable		mm ² x No.	1.0 - 1.5 x 2C	1.0 - 1.5 x 2C	1.0 - 1.5 x 2C
Decoration Panel (Accessory)	Model Name		PT-UQC PT-QCHW0	PT-UQC PT-QCHW0	PT-UQC PT-QCHW0
	Exterior Color		Morning Fog	Morning Fog	Morning Fog
	RAL Code		RAL 9001	RAL 9001	RAL 9001
	Net Dimensions (W x H x D)	mm	700 x 22 x 700 620 x 20 x 620	700 x 22 x 700 620 x 20 x 620	700 x 22 x 700 620 x 20 x 620
	Net Weight	kg	3.0 / 3.0	3.0 / 3.0	3.0 / 3.0

Note : 1. Performance tested under EN14511
2. Capacities are based on the following conditions
- Cooling : Indoor temp. 27°C (80.6°F) DB / 19°C (66.2°F) WB, Outdoor temp. 35°C (95°F) DB / 24°C (75.2°F) WB, Interconnecting piping length 7.5m, Level difference of zero
- Heating : Indoor temp. 20°C (68°F) DB / 15°C (59°F) WB, Outdoor temp. 7°C (44.6°F) DB / 6°C (42.8°F) WB, Interconnecting piping length 7.5m, Level difference of zero
3. Due to our policy of innovation, some specifications may be changed without notification

Accessories

Chassis	ARNU05GTRB4	ARNU07GTRB4	ARNU09GTRB4	ARNU12GTRB4
Drain Pump			○	
Cassette Cover			PTDCQ	
Refrigerant Leakage Detector			PRLDNVSO	
EEV Kit			PRGK024A0 (-4.5kW)	
Independent Power Module			PRIP0	
Robot Cleaner			-	
Pre Filter (Washable)			○	
Ion Generator			-	
CO ₂ Sensor			-	
Ventilation Kit			PTVK430	
IR Receiver			-	
Zone Controller			-	
Dry Contact (with additional accessory)			PDRYCB000 (1 point contact), PDRYCB300 (8 points for thermostat compatible), PDRYCB320 (Universal input ¹⁾), PDRYCB400 (2 points input), PDRYCB500 (Modbus)	
External Input (1 point)			○	
Wi-Fi			PWFMD200	

※ ○ : Applied, - : Not applied
Option : Refer to model name in table
1) Available from April 2020

4 WAY CASSETTE (570 X 570)

ARNU15GTQB4 / ARNU18GTQB4
ARNU21GTQB4



Model	Unit	ARNU15GTQB4	ARNU18GTQB4	ARNU21GTQB4
Cooling Capacity	kW	4.5	5.6	6.0
Heating Capacity	kW	5.0	6.3	6.8
Power Input (H / M / L)	Nominal	W	24 / 21 / 18	25 / 22 / 19
Dimensions (W x H x D)	Body	mm	570 x 256 x 570	570 x 256 x 570
	Shipping	mm	667 x 327 x 646	667 x 327 x 646
Fan	Type		Turbo Fan	Turbo Fan
	Motor Output x Number	W	43 x 1	43 x 1
	Air Flow Rate (H / M / L)	m ³ /min	11.0 / 10.0 / 9.3	11.2 / 11.0 / 10.0
	Motor Type		BLDC	BLDC
Air Filter		Pre Filter	Pre Filter	Pre Filter
Pipe Connections	Liquid Side	mm (inch)	Ø6.35 (1/4)	Ø6.35 (1/4)
	Gas Side	mm (inch)	Ø12.7 (1/2)	Ø12.7 (1/2)
	Drain Pipe (Internal Dia.)	mm (inch)	Ø25 (1)	Ø25 (1)
Weight	Body	kg	15.0	15.0
Sound Pressure Levels (H / M / L)		dB(A)	36 / 34 / 32	37 / 35 / 34
Sound Power Levels (H / M / L)		dB(A)	50 / 48 / 46	51 / 50 / 46
Power Supply		Ø, V, Hz	1,220-240, 50	1,220-240, 50
Communication Cable		mm ² x No.	1.0 - 1.5 x 2C	1.0 - 1.5 x 2C
Decoration Panel (Accessory)	Model Name		PT-UQC PT-QCHW0	PT-UQC PT-QCHW0
	Exterior Color		Morning Fog	Morning Fog
	RAL Code		RAL 9001	RAL 9001
	Net Dimensions (W x H x D)	mm	700 x 22 x 700 620 x 20 x 620	700 x 22 x 700 620 x 20 x 620
	Net Weight	kg	3.0 / 3.0	3.0 / 3.0

Note : 1. Performance tested under EN14511
2. Capacities are based on the following conditions
- Cooling : Indoor temp. 27°C (80.6°F) DB / 19°C (66.2°F) WB, Outdoor temp. 35°C (95°F) DB / 24°C (75.2°F) WB, Interconnecting piping length 7.5m, Level difference of zero
- Heating : Indoor temp. 20°C (68°F) DB / 15°C (59°F) WB, Outdoor temp. 7°C (44.6°F) DB / 6°C (42.8°F) WB, Interconnecting piping length 7.5m, Level difference of zero
3. Due to our policy of innovation, some specifications may be changed without notification

Accessories

Chassis	ARNU15GTQB4	ARNU18GTQB4	ARNU21GTQB4
Drain Pump			○
Cassette Cover			PTDCQ
Refrigerant Leakage Detector			PRLDNVSO
EEV Kit			PRGK024A0 (-4.5kW)
Independent Power Module			PRIP0
Robot Cleaner			-
Pre Filter (Washable)			○
Ion Generator			-
CO ₂ Sensor			-
Ventilation Kit			PTVK430
IR Receiver			-
Zone Controller			-
Dry Contact (with additional accessory)			PDRYCB000 (1 point contact), PDRYCB300 (8 points for thermostat compatible), PDRYCB320 (Universal input ¹⁾), PDRYCB400 (2 points input), PDRYCB500 (Modbus)
External Input (1 point)			○
Wi-Fi			PWFMD200

※ ○ : Applied, - : Not applied
Option : Refer to model name in table
1) Available from April 2020

4 WAY CASSETTE (840 X 840)

ARNU24GTPC4 / ARNU28GTPC4
ARNU30GTPC4 / ARNU36GTNC4



Model	Unit	ARNU24GTPC4	ARNU28GTPC4	ARNU30GTPC4	ARNU36GTNC4
Cooling Capacity	kW	7.1	8.2	9.0	10.6
Heating Capacity	kW	8.0	9.2	10.0	11.9
Power Input (H / M / L)	Nominal W	31 / 26 / 23	40 / 31 / 25	40 / 34 / 27	70 / 53 / 43
Dimensions (W x H x D)	Body	840 x 204 x 840	840 x 204 x 840	840 x 204 x 840	840 x 246 x 840
	Shipping	922 x 276 x 917	922 x 276 x 917	922 x 276 x 917	922 x 318 x 917
Fan	Type	Turbo Fan	Turbo Fan	Turbo Fan	Turbo Fan
	Motor Output x Number	W 30 x 1	30 x 1	30 x 1	135 x 1
	Air Flow Rate (H / M / L)	m³/min 17.0 / 15.0 / 13.0	19.0 / 16.0 / 14.0	24.3 / 22.8 / 19.5	25.0 / 21.0 / 19.0
	Motor Type	BLDC	BLDC	BLDC	BLDC
Air Filter		Pre Filter	Pre Filter	Pre Filter	Pre Filter
Pipe Connections	Liquid Side	mm (inch) Ø9.52 (3/8)	Ø9.52 (3/8)	Ø9.52 (3/8)	Ø9.52 (3/8)
	Gas Side	mm (inch) Ø15.88 (5/8)	Ø15.88 (5/8)	Ø15.88 (5/8)	Ø15.88 (5/8)
	Drain Pipe (Internal Dia.)	mm (inch) Ø25 (1)	Ø25 (1)	Ø25 (1)	Ø25 (1)
Weight	Body kg	20.8	20.8	20.8	23.5
Sound Pressure Levels (H / M / L)	dB(A)	36 / 34 / 31	39 / 35 / 33	40 / 36 / 33	43 / 40 / 37
Sound Power Levels (H / M / L)	dB(A)	46 / 44 / 43	52 / 46 / 44	58 / 57 / 54	56 / 53 / 51
Power Supply	Ø, V, Hz	1, 220-240, 50	1, 220-240, 50	1, 220-240, 50	1, 220-240, 50
Communication Cable	mm² x No.	1.0 - 1.5 x 2C	1.0 - 1.5 x 2C	1.0 - 1.5 x 2C	1.0 - 1.5 x 2C
Decoration Panel (Accessory)	Model Name	PT-UMC1 PT-MCHW0	PT-UMC1 PT-MCHW0	PT-UMC1 PT-MCHW0	PT-UMC1 PT-MCHW0
	Exterior Color	Morning Fog	Morning Fog	Morning Fog	Morning Fog
	RAL Code	RAL 9001	RAL 9001	RAL 9001	RAL 9001
	Net Dimensions (W x H x D)	mm 950 x 25 x 950 950 x 35 x 950	950 x 25 x 950 950 x 35 x 950	950 x 25 x 950 950 x 35 x 950	950 x 25 x 950 950 x 35 x 950
	Net Weight	kg 5.0 / 6.3	5.0 / 6.3	5.0 / 6.3	5.0 / 6.3

Note : 1. Performance tested under EN14511
2. Capacities are based on the following conditions
- Cooling : Indoor temp. 27°C (80.6°F) DB / 19°C (66.2°F) WB, Outdoor temp. 35°C (95°F) DB / 24°C (75.2°F) WB, Interconnecting piping length 7.5m, Level difference of zero
- Heating : Indoor temp. 20°C (68°F) DB / 15°C (59°F) WB, Outdoor temp. 7°C (44.6°F) DB / 6°C (42.8°F) WB, Interconnecting piping length 7.5m, Level difference of zero
3. Due to our policy of innovation, some specifications may be changed without notification

Accessories

Chassis	ARNU24GTPC4	ARNU28GTPC4	ARNU30GTPC4	ARNU36GTNC4
Drain Pump			○	
Cassette Cover			PTDCM	
Refrigerant Leakage Detector			PRLDNVSO	
EEV Kit			-	
Independent Power Module			PRIP0	
Robot Cleaner			-	
Pre Filter (Washable)			○	
Ion Generator			-	
CO ₂ Sensor			-	
Ventilation Kit			PTVK430	
IR Receiver			-	
Zone Controller			-	
Dry Contact (with additional accessory)		PDRYCB000 (1 point contact), PDRYCB300 (8 points for thermostat compatible), PDRYCB320 (Universal input ¹⁾), PDRYCB400 (2 points input), PDRYCB502 (Modbus)		
External Input (1 point)			○	
Wi-Fi			PWFMD200	

※ ○ : Applied, - : Not applied
Option : Refer to model name in table
1) Available from April 2020

4 WAY CASSETTE (840 X 840)

ARNU42GTMC4 / C4ARNU48GTMC4
ARNU54GTMC4



Model	Unit	ARNU42GTMC4	ARNU48GTMC4	ARNU54GTMC4
Cooling Capacity	kW	12.3	14.1	15.8
Heating Capacity	kW	13.8	15.9	18
Power Input (H / M / L)	Nominal W	104 / 75 / 53	120 / 80 / 62	135 / 93 / 70
Dimensions (W x H x D)	Body	840 x 288 x 840	840 x 288 x 840	840 x 288 x 840
	Shipping	922 x 360 x 917	922 x 360 x 917	922 x 360 x 917
Fan	Type	Turbo Fan	Turbo Fan	Turbo Fan
	Motor Output x Number	W 135 x 1	135 x 1	135 x 1
	Air Flow Rate (H / M / L)	m³/min 30.0 / 27.0 / 24.0	31.0 / 29.0 / 27.0	34.0 / 32.0 / 27.0
	Motor Type	BLDC	BLDC	BLDC
Air Filter		Pre Filter	Pre Filter	Pre Filter
Pipe Connections	Liquid Side	mm (inch) Ø9.52 (3/8)	Ø9.52 (3/8)	Ø9.52 (3/8)
	Gas Side	mm (inch) Ø15.88 (5/8)	Ø15.88 (5/8)	Ø15.88 (5/8)
	Drain Pipe (Internal Dia.)	mm (inch) Ø25 (1)	Ø25 (1)	Ø25 (1)
Weight	Body kg	25.6	25.6	26.5
Sound Pressure Levels (H / M / L)	dB(A)	44 / 41 / 38	46 / 43 / 41	50 / 48 / 44
Sound Power Levels (H / M / L)	dB(A)	58 / 55 / 50	60 / 56 / 55	60 / 58 / 55
Power Supply	Ø, V, Hz	1, 220-240, 50	1, 220-240, 50	1, 220-240, 50
Communication Cable	mm² x No.	1.0 - 1.5 x 2C	1.0 - 1.5 x 2C	1.0 - 1.5 x 2C
Decoration Panel (Accessory)	Model Name	PT-UMC1 PT-MCHW0	PT-UMC1 PT-MCHW0	PT-UMC1 PT-MCHW0
	Exterior Color	Morning Fog	Morning Fog	Morning Fog
	RAL Code	RAL 9001	RAL 9001	RAL 9001
	Net Dimensions (W x H x D)	mm 950 x 25 x 950 950 x 35 x 950	950 x 25 x 950 950 x 35 x 950	950 x 25 x 950 950 x 35 x 950
	Net Weight	kg 5.0 / 6.3	5.0 / 6.3	5.0 / 6.3

Note : 1. Performance tested under EN14511
2. Capacities are based on the following conditions
- Cooling : Indoor temp. 27°C (80.6°F) DB / 19°C (66.2°F) WB, Outdoor temp. 35°C (95°F) DB / 24°C (75.2°F) WB, Interconnecting piping length 7.5m, Level difference of zero
- Heating : Indoor temp. 20°C (68°F) DB / 15°C (59°F) WB, Outdoor temp. 7°C (44.6°F) DB / 6°C (42.8°F) WB, Interconnecting piping length 7.5m, Level difference of zero
3. Due to our policy of innovation, some specifications may be changed without notification

Accessories

Chassis	ARNU42GTMC4	ARNU48GTMC4	ARNU54GTMC4
Drain Pump			○
Cassette Cover			PTDCM
Refrigerant Leakage Detector			PRLDNVSO
EEV Kit			-
Independent Power Module			PRIP0
Robot Cleaner			-
Pre Filter (Washable)			○
Ion Generator			-
CO ₂ Sensor			-
Ventilation Kit			PTVK430
IR Receiver			-
Zone Controller			-
Dry Contact (with additional accessory)		PDRYCB000 (1 point contact), PDRYCB300 (8 points for thermostat compatible), PDRYCB320 (Universal input ¹⁾), PDRYCB400 (2 points input), PDRYCB502 (Modbus)	
External Input (1 point)			○
Wi-Fi			PWFMD200

※ ○ : Applied, - : Not applied
Option : Refer to model name in table
1) Available from April 2020

4 WAY CASSETTE (840 X 840)

ARNU07GTNA4 / ARNU09GTNA4
 ARNU12GTNA4 / ARNU15GTNA4
 ARNU18GTNA4



Model	Unit	ARNU07GTNA4	ARNU09GTNA4	ARNU12GTNA4	ARNU15GTNA4	ARNU18GTNA4
Cooling Capacity	kW	2.2	2.8	3.6	4.5	5.6
Heating Capacity	kW	2.5	3.2	4	5	6.3
Power Input (H / M / L)	Nominal W	18 / 15 / 12	19 / 15 / 12	22 / 17 / 14	25 / 17 / 14	27 / 18 / 14
Dimensions (W x H x D)	Body	840 x 246 x 840	840 x 246 x 840	840 x 246 x 840	840 x 246 x 840	840 x 246 x 840
	Shipping	922 x 318 x 917	922 x 318 x 917	922 x 318 x 917	922 x 318 x 917	922 x 318 x 917
Fan	Type	Turbo Fan	Turbo Fan	Turbo Fan	Turbo Fan	Turbo Fan
	Motor Output x Number	W 135 x 1	135 x 1	135 x 1	135 x 1	135 x 1
	Air Flow Rate (H / M / L)	m³/min 13.0 / 12.0 / 11.0	13.5 / 12.0 / 11.0	14.0 / 13.0 / 12.0	15.0 / 13.0 / 12.0	16.0 / 14.0 / 12.0
	Motor Type	BLDC	BLDC	BLDC	BLDC	BLDC
Air Filter		Pre Filter	Pre Filter	Pre Filter	Pre Filter	Pre Filter
Pipe Connections	Liquid Side	mm (inch) Ø9.52 (3/8)	Ø9.52 (3/8)	Ø9.52 (3/8)	Ø9.52 (3/8)	Ø9.52 (3/8)
	Gas Side	mm (inch) Ø15.88 (5/8)	Ø15.88 (5/8)	Ø15.88 (5/8)	Ø15.88 (5/8)	Ø15.88 (5/8)
	Drain Pipe (Internal Dia.)	mm (inch) Ø25 (1)	Ø25 (1)	Ø25 (1)	Ø25 (1)	Ø25 (1)
Weight	Body kg	23.5	23.5	23.5	23.5	23.5
Sound Pressure Levels (H / M / L)	dB(A)	35 / 33 / 30	35 / 33 / 30	37 / 35 / 33	39 / 35 / 33	40 / 35 / 33
Sound Power Levels (H / M / L)	dB(A)	42 / 38 / 36	42 / 38 / 36	43 / 40 / 38	44 / 40 / 38	45 / 41 / 38
Power Supply	Ø, V, Hz	1,220-240,50	1,220-240,50	1,220-240,50	1,220-240,50	1,220-240,50
Communication Cable	mm² x No.	1.0 - 1.5 x 2C	1.0 - 1.5 x 2C	1.0 - 1.5 x 2C	1.0 - 1.5 x 2C	1.0 - 1.5 x 2C
Decoration Panel (Accessory)	Model Name	PT-UMC1 PT-MCHW0	PT-UMC1 PT-MCHW0	PT-UMC1 PT-MCHW0	PT-UMC1 PT-MCHW0	PT-UMC1 PT-MCHW0
	Exterior Color	Morning Fog	Morning Fog	Morning Fog	Morning Fog	Morning Fog
	RAL Code	RAL 9001	RAL 9001	RAL 9001	RAL 9001	RAL 9001
	Net Dimensions (W x H x D)	mm 950 x 25 x 950 950 x 35 x 950	950 x 25 x 950 950 x 35 x 950	950 x 25 x 950 950 x 35 x 950	950 x 25 x 950 950 x 35 x 950	950 x 25 x 950 950 x 35 x 950
	Net Weight	kg 5.0 / 6.3	5.0 / 6.3	5.0 / 6.3	5.0 / 6.3	5.0 / 6.3

Note : 1. Performance tested under EN14511
 2. Capacities are based on the following conditions
 - Cooling : Indoor temp. 27°C (80.6°F) DB / 19°C (66.2°F) WB, Outdoor temp. 35°C (95°F) DB / 24°C (75.2°F) WB, Interconnecting piping length 7.5m, Level difference of zero
 - Heating : Indoor temp. 20°C (68°F) DB / 15°C (59°F) WB, Outdoor temp. 7°C (44.6°F) DB / 6°C (42.8°F) WB, Interconnecting piping length 7.5m, Level difference of zero
 3. Due to our policy of innovation, some specifications may be changed without notification

Accessories

Chassis	ARNU07GTNA4	ARNU09GTNA4	ARNU12GTNA4	ARNU15GTNA4	ARNU18GTNA4
Drain Pump			○		
Cassette Cover			PTDCM		
Refrigerant Leakage Detector			PRLDNVSO		
EEV Kit			-		
Independent Power Module			PRIP0		
Robot Cleaner			-		
Pre Filter (Washable)			○		
Ion Generator			-		
CO ₂ Sensor			-		
Ventilation Kit			PTVK430		
IR Receiver			-		
Zone Controller			-		
Dry Contact (with additional accessory)		PDRYCB000 (1 point contact), PDRYCB300 (8 points for thermostat compatible), PDRYCB320 (Universal input ¹⁾), PDRYCB400 (2 points input), PDRYCB500 (Modbus)			
External Input (1 point)			○		
Wi-Fi			PWFMD200		

※ ○ : Applied, - : Not applied
 Option : Refer to model name in table
 1) Available from April 2020

4 WAY CASSETTE (840 X 840)

ARNU24GTMA4 / ARNU28GTMA4
 ARNU36GTMA4 / ARNU42GTMA4



Model	Unit	ARNU24GTMA4	ARNU28GTMA4	ARNU36GTMA4	ARNU42GTMA4
Cooling Capacity	kW	7.1	8.2	10.6	12.3
Heating Capacity	kW	8	9.2	11.9	13.8
Power Input (H / M / L)	Nominal W	47 / 39 / 31	52 / 43 / 31	64 / 47 / 34	104 / 75 / 53
Dimensions (W x H x D)	Body	840 x 288 x 840	840 x 288 x 840	840 x 288 x 840	840 x 288 x 840
	Shipping	922 x 360 x 917	922 x 360 x 917	922 x 360 x 917	922 x 360 x 917
Fan	Type	Turbo Fan	Turbo Fan	Turbo Fan	Turbo Fan
	Motor Output x Number	W 135 x 1	135 x 1	135 x 1	135 x 1
	Air Flow Rate (H / M / L)	m³/min 22.0 / 20.0 / 18.0	23.0 / 21.0 / 18.0	26.0 / 23.0 / 20.0	30.0 / 26.0 / 23.0
	Motor Type	BLDC	BLDC	BLDC	BLDC
Air Filter		Pre Filter	Pre Filter	Pre Filter	Pre Filter
Pipe Connections	Liquid Side	mm (inch) Ø9.52 (3/8)	Ø9.52 (3/8)	Ø9.52 (3/8)	Ø9.52 (3/8)
	Gas Side	mm (inch) Ø15.88 (5/8)	Ø15.88 (5/8)	Ø15.88 (5/8)	Ø15.88 (5/8)
	Drain Pipe (Internal Dia.)	mm (inch) Ø25 (1)	Ø25 (1)	Ø25 (1)	Ø25 (1)
Weight	Body kg	25.6	25.6	25.6	25.6
Sound Pressure Levels (H / M / L)	dB(A)	42 / 40 / 38	43 / 41 / 38	46 / 42 / 39	49 / 45 / 42
Sound Power Levels (H / M / L)	dB(A)	48 / 45 / 43	49 / 47 / 43	52 / 48 / 44	55 / 51 / 48
Power Supply	Ø, V, Hz	1,220 - 240,50	1,220 - 240,50	1,220 - 240,50	1,220 - 240,50
Communication Cable	mm² x No.	1.0 - 1.5 x 2C	1.0 - 1.5 x 2C	1.0 - 1.5 x 2C	1.0 - 1.5 x 2C
Decoration Panel (Accessory)	Model Name	PT-UMC1 PT-MCHW0	PT-UMC1 PT-MCHW0	PT-UMC1 PT-MCHW0	PT-UMC1 PT-MCHW0
	Exterior Color	Morning Fog	Morning Fog	Morning Fog	Morning Fog
	RAL Code	RAL 9001	RAL 9001	RAL 9001	RAL 9001
	Net Dimensions (W x H x D)	mm 950 x 25 x 950 950 x 35 x 950	950 x 25 x 950 950 x 35 x 950	950 x 25 x 950 950 x 35 x 950	950 x 25 x 950 950 x 35 x 950
	Net Weight	kg 5.0 / 6.3	5.0 / 6.3	5.0 / 6.3	5.0 / 6.3

Note : 1. Performance tested under EN14511
 2. Capacities are based on the following conditions
 - Cooling : Indoor temp. 27°C (80.6°F) DB / 19°C (66.2°F) WB, Outdoor temp. 35°C (95°F) DB / 24°C (75.2°F) WB, Interconnecting piping length 7.5m, Level difference of zero
 - Heating : Indoor temp. 20°C (68°F) DB / 15°C (59°F) WB, Outdoor temp. 7°C (44.6°F) DB / 6°C (42.8°F) WB, Interconnecting piping length 7.5m, Level difference of zero
 3. Due to our policy of innovation, some specifications may be changed without notification

Accessories

Chassis	ARNU24GTMA4	ARNU28GTMA4	ARNU36GTMA4	ARNU42GTMA4
Drain Pump			○	
Cassette Cover			PTDCM	
Refrigerant Leakage Detector			PRLDNVSO	
EEV Kit			-	
Independent Power Module			PRIP0	
Robot Cleaner			-	
Pre Filter (Washable)			○	
Ion Generator			-	
CO ₂ Sensor			-	
Ventilation Kit			PTVK430	
IR Receiver			-	
Zone Controller			-	
Dry Contact (with additional accessory)		PDRYCB000 (1 point contact), PDRYCB300 (8 points for thermostat compatible), PDRYCB320 (Universal input ¹⁾), PDRYCB400 (2 points input), PDRYCB500 (Modbus)		
External Input (1 point)			○	
Wi-Fi			PWFMD200	

※ ○ : Applied, - : Not applied
 Option : Refer to model name in table
 1) Available from April 2020

2 WAY CASSETTE

ARNU09GTSC4 / ARNU12GTSC4



Model	Unit	ARNU09GTSC4	ARNU12GTSC4
Cooling Capacity	kW	2.8	3.6
Heating Capacity	kW	3.2	4.0
Power Input (H / M / L)	Nominal W	16 / 14 / 11	18 / 14 / 11
Dimensions (W x H x D)	Body	830 x 225 x 600	830 x 225 x 600
	Shipping	1,055 x 290 x 682	1,055 x 290 x 682
Fan	Type	Turbo Fan	Turbo Fan
	Motor Output x Number	W x No.	37 x 1
	Air Flow Rate (H / M / L)	m ³ /min	10.8 / 9.8 / 9.1
	Motor Type		BLDC
Air Filter		Pre Filter	Pre Filter
Pipe Connections	Liquid Side	mm (inch)	Ø6.35 (1/4)
	Gas Side	mm (inch)	Ø12.7 (1/2)
	Drain Pipe (Internal Dia.)	mm (inch)	Ø25 (1)
Weight	Body	kg	18.1
Sound Pressure Levels (H / M / L)		dB(A)	33 / 31 / 29
Sound Power Levels (H / M / L)		dB(A)	42 / 40 / 38
Power Supply		Ø, V, Hz	1, 220-240, 50
Communication Cable		mm ² x No.	1.0 - 1.5 x 2C
Decoration Panel (Accessory)	Model Name		PT-USC
	Exterior Color		Morning Fog
	RAL Code		RAL 9001
	Net Dimensions (W x H x D)	mm	1,100 x 28 x 690
	Net Weight	kg	4.7

Note : 1. Performance tested under EN14511
 2. Capacities are based on the following conditions
 - Cooling : Indoor temp. 27°C (80.6°F) DB / 19°C (66.2°F) WB, Outdoor temp. 35°C (95°F) DB / 24°C (75.2°F) WB, Interconnecting piping length 7.5m, Level difference of zero
 - Heating : Indoor temp. 20°C (68°F) DB / 15°C (59°F) WB, Outdoor temp. 7°C (44.6°F) DB / 6°C (42.8°F) WB, Interconnecting piping length 7.5m, Level difference of zero
 3. Due to our policy of innovation, some specifications may be changed without notification

Accessories

Chassis	ARNU09GTSC4	ARNU12GTSC4
Drain Pump		○
Cassette Cover		-
Refrigerant Leakage Detector		PRLDNVSO
EEV Kit		PRGK024A0 (-5.6kW)
Independent Power Module		PRIP0
Robot Cleaner		-
Pre Filter (Washable)		○
Ion Generator		-
CO₂ Sensor		-
Ventilation Kit		-
IR Receiver		-
Zone Controller		-
Dry Contact (with additional accessory)		PDRYCB000 (1 point contact), PDRYCB300 (8 points for thermostat compatible), PDRYCB320 (Universal input ¹⁾), PDRYCB400 (2 points input), PDRYCB500 (Modbus)
External Input (1 point)		○
Wi-Fi		PWFMDD200

※ ○ : Applied, - : Not applied
 Option : Refer to model name in table
 1) Available from April 2020

2 WAY CASSETTE

ARNU18GTSC4 / ARNU24GTSC4



Model	Unit	ARNU18GTSC4	ARNU24GTSC4
Cooling Capacity	kW	5.6	7.1
Heating Capacity	kW	6.3	8.0
Power Input (H / M / L)	Nominal W	19 / 16 / 14	31 / 22 / 14
Dimensions (W x H x D)	Body	830 x 225 x 600	830 x 225 x 600
	Shipping	1,055 x 290 x 682	1,055 x 290 x 682
Fan	Type	Turbo Fan	Turbo Fan
	Motor Output x Number	W x No.	37 x 1
	Air Flow Rate (H / M / L)	m ³ /min	11.8 / 10.8 / 9.8
	Motor Type		BLDC
Air Filter		Pre Filter	Pre Filter
Pipe Connections	Liquid Side	mm (inch)	Ø6.35 (1/4)
	Gas Side	mm (inch)	Ø12.7 (1/2)
	Drain Pipe (Internal Dia.)	mm (inch)	Ø25 (1)
Weight	Body	kg	18.1
Sound Pressure Levels (H / M / L)		dB(A)	35 / 33 / 31
Sound Power Levels (H / M / L)		dB(A)	44 / 42 / 40
Power Supply		Ø, V, Hz	1, 220-240, 50
Communication Cable		mm ² x No.	1.0 - 1.5 x 2C
Decoration Panel (Accessory)	Model Name		PT-USC
	Exterior Color		Morning Fog
	RAL Code		RAL 9001
	Net Dimensions (W x H x D)	mm	1,100 x 28 x 690
	Net Weight	kg	4.7

Note : 1. Performance tested under EN14511
 2. Capacities are based on the following conditions
 - Cooling : Indoor temp. 27°C (80.6°F) DB / 19°C (66.2°F) WB, Outdoor temp. 35°C (95°F) DB / 24°C (75.2°F) WB, Interconnecting piping length 7.5m, Level difference of zero
 - Heating : Indoor temp. 20°C (68°F) DB / 15°C (59°F) WB, Outdoor temp. 7°C (44.6°F) DB / 6°C (42.8°F) WB, Interconnecting piping length 7.5m, Level difference of zero
 3. Due to our policy of innovation, some specifications may be changed without notification

Accessories

Chassis	ARNU18GTSC4	ARNU24GTSC4
Drain Pump		○
Cassette Cover		-
Refrigerant Leakage Detector		PRLDNVSO
EEV Kit		PRGK024A0 (-5.6kW)
Independent Power Module		PRIP0
Robot Cleaner		-
Pre Filter (Washable)		○
Ion Generator		-
CO₂ Sensor		-
Ventilation Kit		-
IR Receiver		-
Zone Controller		-
Dry Contact (with additional accessory)		PDRYCB000 (1 point contact), PDRYCB300 (8 points for thermostat compatible), PDRYCB320 (Universal input ¹⁾), PDRYCB400 (2 points input), PDRYCB500 (Modbus)
External Input (1 point)		○
Wi-Fi		PWFMDD200

※ ○ : Applied, - : Not applied
 Option : Refer to model name in table
 1) Available from April 2020

1 WAY CASSETTE

ARNU07GTUB4 / ARNU09GTUB4
ARNU12GTUB4



Model	Unit	ARNU07GTUB4	ARNU09GTUB4	ARNU12GTUB4	
Cooling Capacity	kW	2.2	2.8	3.6	
Heating Capacity	kW	2.5	3.2	4.0	
Power Input (H / M / L)	Nominal W	20 / 18 / 16	22 / 20 / 18	24 / 22 / 20	
Dimensions (W x H x D)	Body	860 x 132 x 450	860 x 132 x 450	860 x 132 x 450	
	Shipping	1,129 x 259 x 538	1,129 x 259 x 538	1,129 x 259 x 538	
Fan	Type	Cross Flow Fan	Cross Flow Fan	Cross Flow Fan	
	Motor Output x Number	W x No.	30 x 1	30 x 1	
	Air Flow Rate (H / M / L)	m ³ /min	8.2 / 7.3 / 6.4	9.2 / 8.6 / 8.2	10.0 / 9.2 / 8.2
	Motor Type		BLDC	BLDC	
Air Filter		Pre Filter	Pre Filter	Pre Filter	
Pipe Connections	Liquid Side	mm (inch)	Ø6.35 (1/4)	Ø6.35 (1/4)	
	Gas Side	mm (inch)	Ø12.7 (1/2)	Ø12.7 (1/2)	
	Drain Pipe (Internal Dia.)	mm (inch)	Ø25 (1)	Ø25 (1)	
Weight	Body	kg	13.6	13.6	
Sound Pressure Levels (H / M / L)		dB(A)	32 / 29 / 25	35 / 34 / 32	38 / 35 / 32
Sound Power Levels (H / M / L)		dB(A)	47 / 44 / 41	50 / 48 / 47	52 / 50 / 47
Power Supply		Ø, V, Hz	1, 220-240, 50	1, 220-240, 50	1, 220-240, 50
Communication Cable		mm ² x No.	1.0 - 1.5 x 2C	1.0 - 1.5 x 2C	1.0 - 1.5 x 2C
Decoration Panel (Accessory)	Model Name		PT-UUC (Grill), PT-UUD (Panel)	PT-UUC (Grill), PT-UUD (Panel)	PT-UUC (Grill), PT-UUD (Panel)
	Exterior Color		Noble White	Noble White	Noble White
	RAL Code		RAL 9003	RAL 9003	RAL 9003
	Net Dimensions (W x H x D)	mm	1,100 x 34 x 500	1,100 x 34 x 500	1,100 x 34 x 500
	Net Weight	kg	4.6 / 5.3	4.6 / 5.3	4.6 / 5.3

Note : 1. Performance tested under EN14511
 2. Capacities are based on the following conditions
 - Cooling : Indoor temp. 27°C (80.6°F) DB / 19°C (66.2°F) WB, Outdoor temp. 35°C (95°F) DB / 24°C (75.2°F) WB, Interconnecting piping length 7.5m, Level difference of zero
 - Heating : Indoor temp. 20°C (68°F) DB / 15°C (59°F) WB, Outdoor temp. 7°C (44.6°F) DB / 6°C (42.8°F) WB, Interconnecting piping length 7.5m, Level difference of zero
 3. Due to our policy of innovation, some specifications may be changed without notification

Accessories

Chassis	ARNU07GTUB4	ARNU09GTUB4	ARNU12GTUB4
Drain Pump		○	
Cassette Cover		-	
Refrigerant Leakage Detector		PRLDNVSO	
EEV Kit		PRGK024A0	
Independent Power Module		PRIPO	
Robot Cleaner		-	
Pre Filter (Washable)		○	
Ion Generator		-	
CO ₂ Sensor		-	
Ventilation Kit		-	
IR Receiver		-	
Zone Controller		-	
Dry Contact (with additional accessory)		PDRYCB000 (1 point contact), PDRYCB300 (8 points for thermostat compatible), PDRYCB320 (Universal input ¹⁾), PDRYCB400 (2 points input), PDRYCB500 (Modbus)	
External Input (1 point)		○	
Wi-Fi		PWFMD200	

※ ○ : Applied, - : Not applied
 Option : Refer to model name in table
 1) Available from April 2020

1 WAY CASSETTE

ARNU18GTTB4 / ARNU24GTTB4



Model	Unit	ARNU18GTTB4	ARNU24GTTB4
Cooling Capacity	kW	5.6	7.1
Heating Capacity	kW	6.3	7.1
Power Input (H / M / L)	Nominal W	38 / 28 / 24	51 / 33 / 26
Dimensions (W x H x D)	Body	mm	1,180 x 132 x 450
	Shipping	mm	1,499 x 259 x 538
Fan	Type		Cross Flow Fan
	Motor Output x Number	W x No.	30 x 1
	Air Flow Rate (H / M / L)	m ³ /min	13.3 / 12.1 / 10.9
	Motor Type		BLDC
Air Filter		Pre Filter	Pre Filter
Pipe Connections	Liquid Side	mm (inch)	Ø6.35 (1/4)
	Gas Side	mm (inch)	Ø12.7 (1/2)
	Drain Pipe (Internal Dia.)	mm (inch)	Ø25 (1)
Weight	Body	kg	15.6
Sound Pressure Levels (H / M / L)		dB(A)	40 / 37 / 35
Sound Power Levels (H / M / L)		dB(A)	56 / 51 / 48
Power Supply		Ø, V, Hz	1, 220-240, 50
Communication Cable		mm ² x No.	1.0 - 1.5 x 2C
Decoration Panel (Accessory)	Model Name		PT-UUC (Grill), PT-UUD (Panel)
	Exterior Color		Noble White
	RAL Code		RAL 9003
	Net Dimensions (W x H x D)	mm	1,420 x 34 x 500
	Net Weight	kg	5.5 / 6.5

Note : 1. Performance tested under EN14511
 2. Capacities are based on the following conditions
 - Cooling : Indoor temp. 27°C (80.6°F) DB / 19°C (66.2°F) WB, Outdoor temp. 35°C (95°F) DB / 24°C (75.2°F) WB, Interconnecting piping length 7.5m, Level difference of zero
 - Heating : Indoor temp. 20°C (68°F) DB / 15°C (59°F) WB, Outdoor temp. 7°C (44.6°F) DB / 6°C (42.8°F) WB, Interconnecting piping length 7.5m, Level difference of zero
 3. Due to our policy of innovation, some specifications may be changed without notification

Accessories

Chassis	ARNU18GTTB4	ARNU24GTTB4	
Drain Pump		○	
Cassette Cover		-	
Refrigerant Leakage Detector		PRLDNVSO	
EEV Kit		-	
Independent Power Module		PRIPO	
Robot Cleaner		-	
Pre Filter (Washable)		○	
Ion Generator		-	
CO ₂ Sensor		-	
Ventilation Kit		-	
IR Receiver		-	
Zone Controller		-	
Dry Contact (with additional accessory)		PDRYCB000 (1 point contact), PDRYCB300 (8 points for thermostat compatible), PDRYCB320 (Universal input ¹⁾), PDRYCB400 (2 points input), PDRYCB500 (Modbus)	
External Input (1 point)		○	
Wi-Fi		PWFMD200	

※ ○ : Applied, - : Not applied
 Option : Refer to model name in table
 1) Available from April 2020

CEILING MOUNTED ROUND CASSETTE



Features & Benefits

- Luxury round design can make a luxurious space with a round design considering side view.
- Perfect round air flow without blind spots.

Key Applications

- Retail
- Restaurant
- Office
- Hotel

	Cassette	Round
Smart	Wi-Fi	0
Energy Efficiency	Human Detect Sensor	-
	Drain Pump	0
	Sleep Mode	0
Comfort	Timer (On / Off)	0
	Timer (Weekly)	0
	Two Thermistor Control	0
	Group Control	0

NEW DESIGN

Slim and Compact design

Reduce the height of the body by 15% save space and maximize the openness of the interior space.

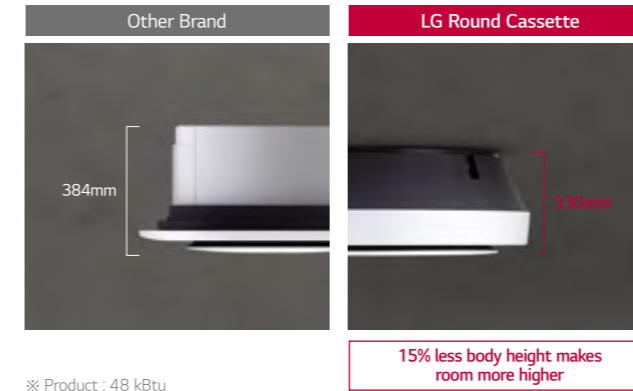

Minimal exposure design

Pipes are brought together in one place to minimize exposure. Hanger covers hide installations to add a clean look.

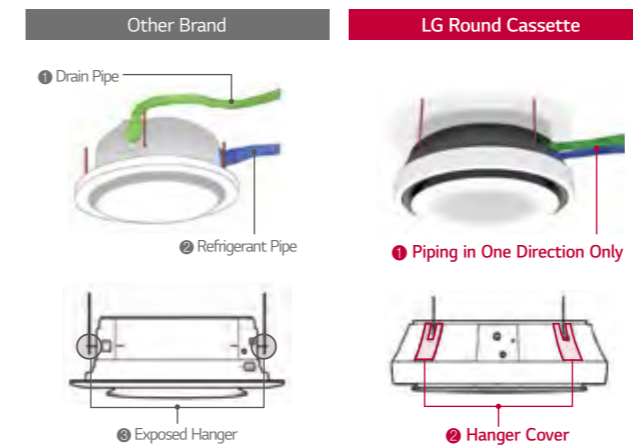

Perfect round air flow

Perfect round flow without blind spots.

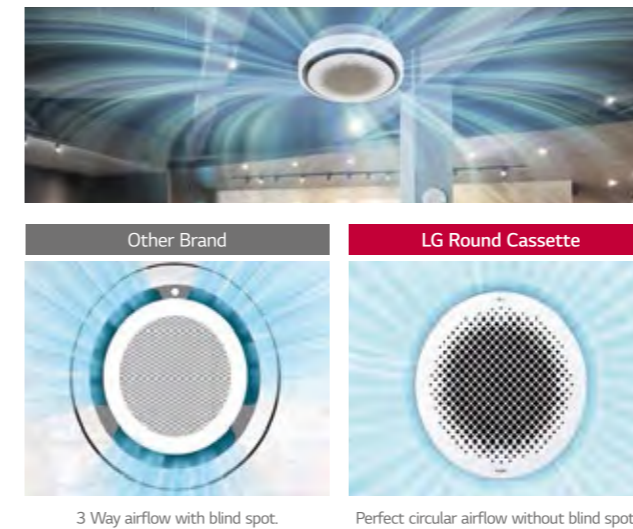

Visible air flow

With crystal vein for 6-step precision control, you can send cool / heated air wherever you want.

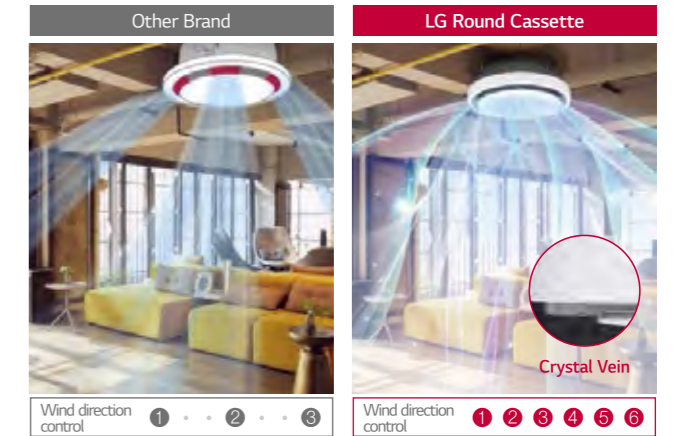

Powerful and Quiet air flow

3D fan increases airflow by 5% and noise reduction technology makes a quieter, more comfortable space.

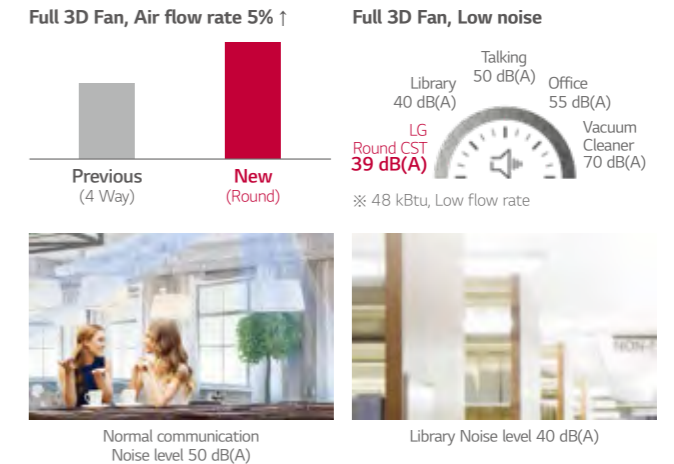

30% Faster in cooling

Larger airflow rate, cooling rate is faster than 30%.

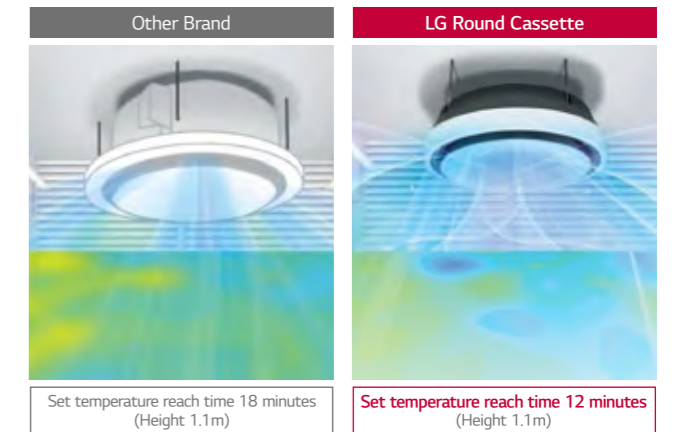

※ Based on test results from LG chamber, this image is designed to help customers understand. Experimental environment: height 3.2m, 48 kBtu, cooling mode, high flow rate, horizontal air flow direction

ROUND CEILING CASSETTE

ARNU24GTYA4 / ARNU36GTYA4
ARNU48GTYA4

Available from **JUNE 2020**



Model	Unit	ARNU24GTYA4	ARNU36GTYA4	ARNU48GTYA4
Cooling Capacity	kW	7.1	10.6	14.1
Heating Capacity	kW	8.0	11.9	15.9
Power Input (H / M / L)	Nominal W	44 / 36 / 29	63 / 47 / 36	98 / 70 / 44
Dimensions (W x H x D)	Body mm	1,050 x 330 x 1,050	1,050 x 330 x 1,050	1,050 x 330 x 1,050
	Shipping mm	1,137 x 395 x 1,132	1,137 x 395 x 1,132	1,137 x 395 x 1,132
Fan	Type	3D Turbo Fan	3D Turbo Fan	3D Turbo Fan
	Motor Output x Number W	157 x 1	157 x 1	157 x 1
	Air Flow Rate (H / M / L) m ³ /min	22 / 21 / 19	27 / 24 / 21	32 / 28 / 23
	Motor Type	BLDC	BLDC	BLDC
Air Filter		Long life	Long life	Long life
	Liquid Side mm (inch)	Ø9.52 (3/8)	Ø9.52 (3/8)	Ø9.52 (3/8)
Pipe Connections	Gas Side mm (inch)	Ø15.88 (5/8)	Ø15.88 (5/8)	Ø15.88 (5/8)
	Drain Pipe(Internal Dia.) mm (inch)	Ø25 (1)	Ø25 (1)	Ø25 (1)
Weight	Body kg	30	30	30
Sound Pressure Level (H / M / L)	dB(A)	39 / 37 / 34	43 / 39 / 37	47 / 44 / 39
Sound Power Level (H / M / L)	dB(A)	48 / 46 / 43	52 / 48 / 46	56 / 53 / 48
Power Supply	Ø, V, Hz	1, 220-240, 50	1, 220-240, 50	1, 220-240, 50
Communication Cable	mm ² x No.	1.0-1.5 x 2C	1.0-1.5 x 2C	1.0-1.5 x 2C

Note : 1. Performance tested under EN14511
 2. Capacities are based on the following conditions
 - Cooling : Indoor temp. 27°C (80.6°F) DB / 19°C (66.2°F) WB, Outdoor temp. 35°C (95°F) DB / 24°C (75.2°F) WB, Interconnecting piping length 7.5m, Level difference of zero
 - Heating : Indoor temp. 20°C (68°F) DB / 15°C (59°F) WB, Outdoor temp. 7°C (44.6°F) DB / 6°C (42.8°F) WB, Interconnecting piping length 7.5m, Level difference of zero
 3. Due to our policy of innovation, some specifications may be changed without notification

Accessories

Chassis	ARNU07GM1A4	ARNU09GM1A4	ARNU12GM1A4
Drain Pump		○	
Cassette Cover		-	
Refrigerant Leakage Detector		PRLDNV50	
EEV Kit		-	
Independent Power Module		PRIPO	
Robot Cleaner		-	
Pre Filter (Washable)		○	
Ion Generator		-	
CO2 Sensor		-	
Ventilation Kit		-	
IR Receiver		-	
Zone Controller		-	
Dry Contact (with additional accessory)		PDRYCB000 (1 point contact), PDRYCB300 (8 points for thermostat compatible), PDRYCB320 (Universal input ¹⁾), PDRYCB400 (2 points input), PDRYCB500 (Modbus)	
External Input (1 Point)		○	
Wi-Fi		PWFMDD200	
Human detection sensor		-	
Floor Temperature Sensor		-	
Air cleaning kit		-	
Elevation Grille		-	

※ ○ : Applied, - : Not applied
 Option : Refer to model name in table
 1) Available from April 2020



CEILING CONCEALED DUCT



Features & Benefits

- Easy and flexible duct adjusts air volume with External Static Pressure (ESP) control function.
- Minimalist visibility (Hidden within ceiling) to blend seamlessly into any interior

Key Applications

- Office
- Hotel
- Retail
- Residential building

	Duct	High	Middle	Low
Smart	Wi-Fi	○	○	○
Energy Efficiency	E.S.P Control	○	○	○
	Drain Pump	○	○	○
Comfort	Timer (On / Off)	○	○	○
	Timer (Weekly)	○	○	○
	Two Thermistor Control	○	○	○
	Group Control	○	○	○

※ ○ : Applied, - : Not applied

SMART

Wi-Fi Control

Anytime, anywhere access with LG ThinQ mobile app.

LG ThinQ
 Search "LG ThinQ" on Google market or Appstore then download the app.

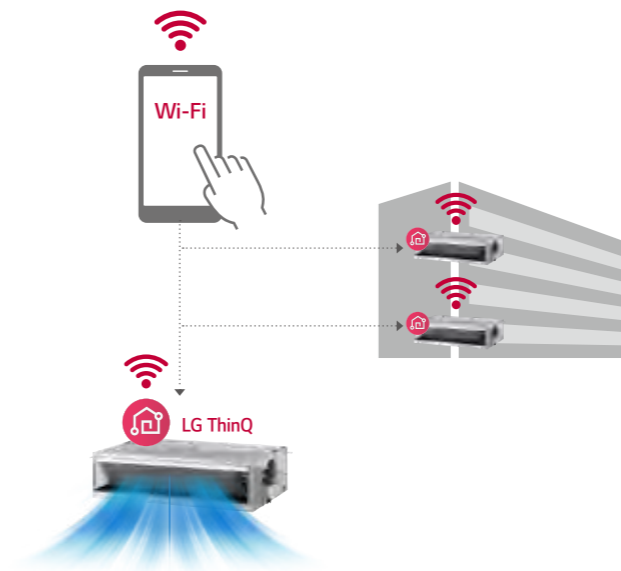

Easy Registration and Log-in

Follow the easy set-up steps that will activate LG ThinQ's user-friendly features.



Simple operation for various functions

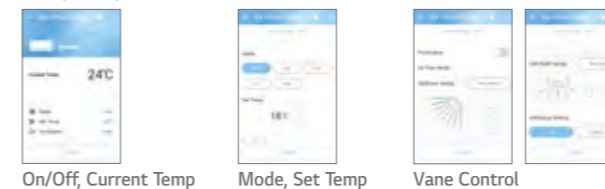

On/Off, Current Temp Mode, Set Temp Vane Control

ENERGY EFFICIENCY

External Static Pressure (ESP) Control

User has easy access to air volume selection via remote controller using the ESP control function. The BLDC motor can control fan speed and air volume. No additional accessories are necessary to control air flow.

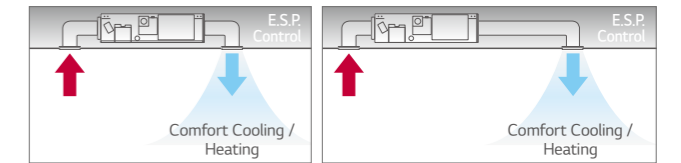

Static Pressure 11- Step Control

Depending on the installation environment, LG's ceiling concealed duct controls the static pressure with 11 steps to provide maximized comfort to any environment.

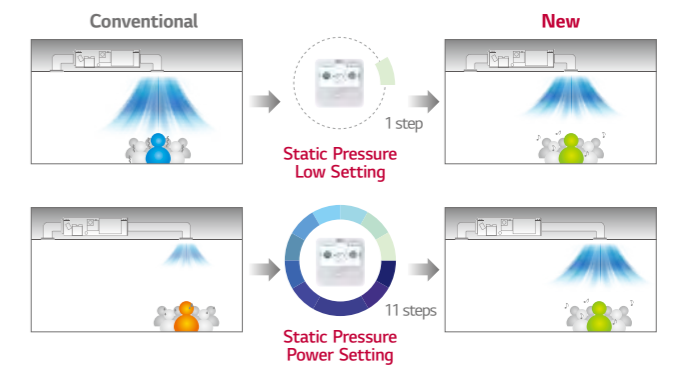

Energy Monitoring

Accumulated electric energy of the indoor unit can be identified with wired remote control, as well as with the central controller. This function is an advantage for energy management.

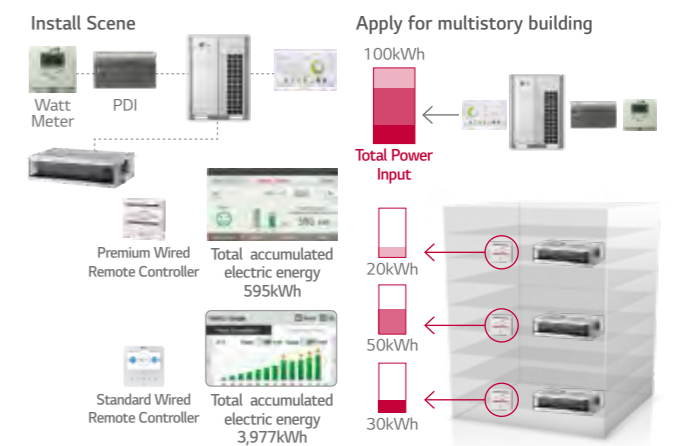

※ Outdoor unit's accumulated electric energy / using rate of individual indoor unit + indoor unit's accumulated electric energy is displayed in wired remote controller, only when central controller, digital integrating electricity meter and PDI are installed and PDI, outdoor unit and indoor unit are connected with power wire. Only total accumulated electric energy is displayed in standard wired remote controller. In premium wired remote controller, that are displayed into week / month / year.

COMFORT

Multiple Room Operation

Using a spiral duct (Embedded or flexible type) and stream chamber, it is possible to operate cooling / heating for several rooms simultaneously.

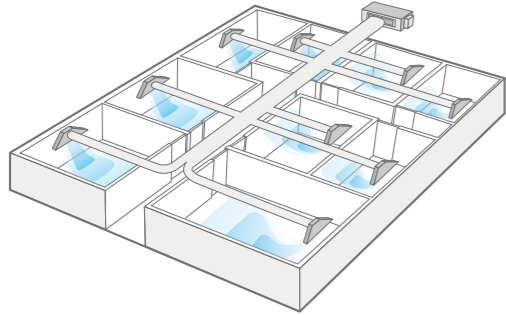

Filter Alert

The alarm is activated when the filter needs to be cleaned, and the time remaining for cleaning is displayed on the screen.

Remain Time Until Indoor Filter Cleaning + Alarm

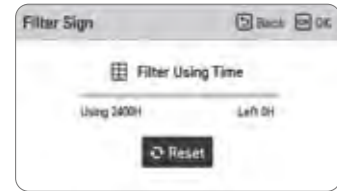

Remain time until indoor filter cleaning 2,400hr.

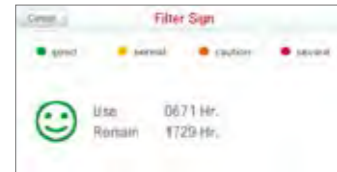

Remain time until indoor filter cleaning 1,729hr.

Flexible Installation (Low Static Duct Only)

The low static duct allows the air intake at the rear or bottom under specific installation conditions.

Air intake at the rear or bottom

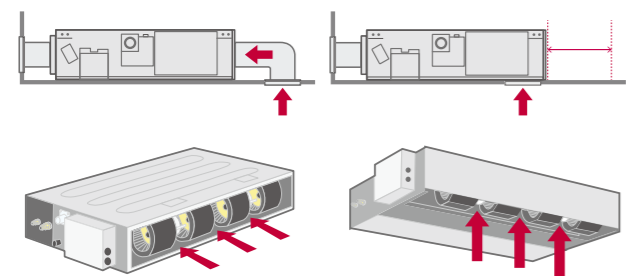

Minimized Height

New mid-static ducts provide ideal solution for installation in limited space.

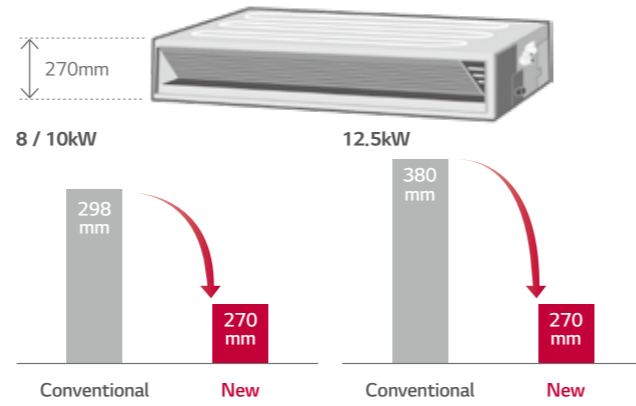

Two Thermistors Control

The indoor temperature can be checked using the thermistors in the remote controller as well as from the indoor unit. There may be a significant difference between ceiling and floor air temperature. Two thermistors can optimise indoor air temperature for a more comfortable environment.

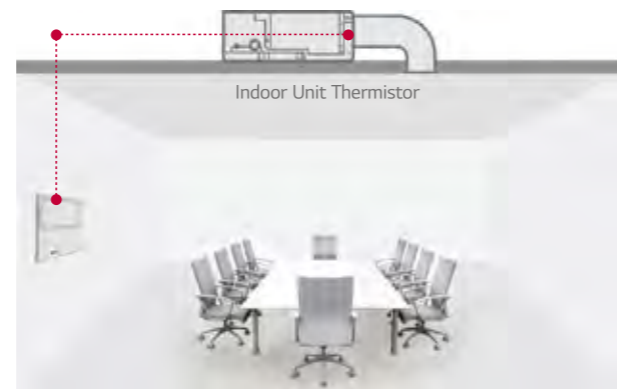

Remote Controller Thermistor

1 Point External Input (On / Off Control)

Indoor unit can be controlled by external devices without dry contact, so customer can save cost of installation.

Connection between an indoor unit and external devices directly

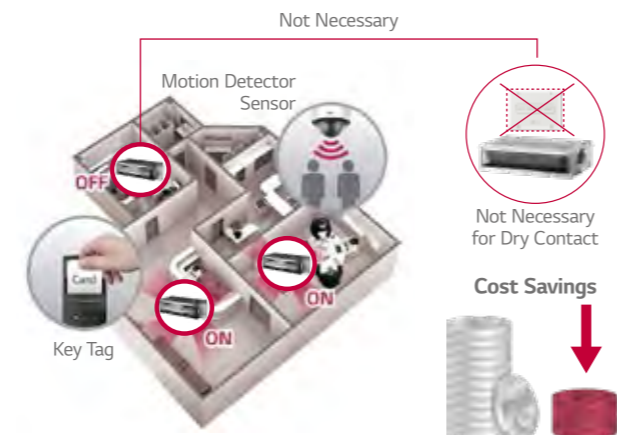

※ In case of needing more functions beside on / off control, a dry contact is required to be installed.



MID STATIC

ARNU07GM1A4 / ARNU09GM1A4
 ARNU12GM1A4 / ARNU15GM1A4
 ARNU18GM1A4 / ARNU24GM1A4



Model	Unit	ARNU07GM1A4	ARNU09GM1A4	ARNU12GM1A4	ARNU15GM1A4	ARNU18GM1A4	ARNU24GM1A4	
Cooling Capacity	kW	2.2	2.8	3.6	4.5	5.6	7.1	
Heating Capacity	kW	2.5	3.2	4.0	5.0	6.3	8.0	
Power Input (H / M / L)	Nominal	W	39 / 30 / 25	40 / 32 / 26	46 / 38 / 31	67 / 53 / 46	85 / 63 / 55	91 / 74 / 58
	Body	mm	900 x 270 x 700	900 x 270 x 700	900 x 270 x 700	900 x 270 x 700	900 x 270 x 700	900 x 270 x 700
Dimensions (W x H x D)	Shipping	mm	1,100 x 338 x 773	1,100 x 338 x 773	1,100 x 338 x 773	1,100 x 338 x 773	1,100 x 338 x 773	1,100 x 338 x 773
	Type		Sirocco Fan	Sirocco Fan	Sirocco Fan	Sirocco Fan	Sirocco Fan	Sirocco Fan
Fan	Motor Output x Number	W x No.	136 x 1	136 x 1	136 x 1	136 x 1	136 x 1	136 x 1
	Air Flow Rate (H / M / L)	m³/min	9.0 / 7.5 / 6.0	9.5 / 7.5 / 6.0	11.0 / 9.0 / 7.0	16.0 / 12.0 / 9.0	17.0 / 14.5 / 12.0	19.0 / 16.0 / 14.0
	External Static Pressure (High Mode)	mmAq (Pa)	6 (59)	6 (59)	6 (59)	6 (59)	6 (59)	6 (59)
	Air Flow Rate (H / M / L) (Standard Mode)	m³/min	9.0 / 7.5 / 6.0	9.5 / 7.5 / 6.0	11.0 / 9.0 / 7.0	16.0 / 12.0 / 9.0	17.0 / 14.5 / 12.0	19.0 / 16.0 / 14.0
	External Static Pressure (Standard Mode)	mmAq (Pa)	2.5 (25)	2.5 (25)	2.5 (25)	2.5 (25)	2.5 (25)	2.5 (25)
	Motor Type		BLDC	BLDC	BLDC	BLDC	BLDC	BLDC
	Air Filter		Pre Filter	Pre Filter	Pre Filter	Pre Filter	Pre Filter	Pre Filter
Pipe Connections	Liquid Side	mm (inch)	Ø6.35 (1/4)	Ø6.35 (1/4)	Ø6.35 (1/4)	Ø6.35 (1/4)	Ø9.52 (3/8)	
	Gas Side	mm (inch)	Ø12.7 (1/2)	Ø12.7 (1/2)	Ø12.7 (1/2)	Ø12.7 (1/2)	Ø15.88 (5/8)	
	Drain Pipe (Internal Dia.)	mm (inch)	25 (1)	25 (1)	Ø25 (1)	Ø25 (1)	Ø25 (1)	
Weight	Body	kg	25.5	25.5	25.5	25.5	26.5	
Sound Pressure Levels (H / M / L)		dB(A)	26 / 24 / 23	27 / 25 / 23	27 / 25 / 23	30 / 27 / 23	31 / 28 / 25	32 / 29 / 26
Sound Power Levels (H / M / L)		dB(A)	55 / 54 / 51	55 / 54 / 52	56 / 54 / 52	59 / 57 / 55	59 / 57 / 55	59 / 58 / 56
Power Supply		Ø, V, Hz	1, 220-240, 50	1, 220-240, 50	1, 220-240, 50	1, 220-240, 50	1, 220-240, 50	1, 220-240, 50
Communication Cable		mm² x No.	1.0 ~ 1.5 x 2C	1.0 ~ 1.5 x 2C	1.0 ~ 1.5 x 2C	1.0 ~ 1.5 x 2C	1.0 ~ 1.5 x 2C	

Note: 1. Performance tested under EN14511
 2. Capacities are based on the following conditions
 - Cooling: Indoor temp. 27°C (80.6°F) DB / 19°C (66.2°F) WB, Outdoor temp. 35°C (95°F) DB / 24°C (75.2°F) WB, Interconnecting piping length 7.5m, Level difference of zero
 - Heating: Indoor temp. 20°C (68°F) DB / 15°C (59°F) WB, Outdoor temp. 7°C (44.6°F) DB / 6°C (42.8°F) WB, Interconnecting piping length 7.5m, Level difference of zero
 3. Due to our policy of innovation, some specifications may be changed without notification

Accessories

Chassis	ARNU07GM1A4	ARNU09GM1A4	ARNU12GM1A4	ARNU15GM1A4	ARNU18GM1A4	ARNU24GM1A4
Drain Pump						○
Cassette Cover						-
Refrigerant Leakage Detector				PRLDNVSO		
EEV Kit				PRGK024A0 (-5.6kW)		
Independent Power Module				PRIP0		
Robot Cleaner				-		
Pre Filter (Washable)				○		
Ion Generator				-		
CO ₂ Sensor				-		
Ventilation Kit				-		
IR Receiver				PWLRVN000		
Zone Controller				ABZCA		
Dry Contact (with additional accessory)				PDRYCB000 (1 point contact), PDRYCB300 (8 points for thermostat compatible), PDRYCB320 (Universal input ¹⁾), PDRYCB400 (2 points input), PDRYCB500 (Modbus)		
External Input (1 point)				○		
Wi-Fi				PWFMD200		

※ ○ : Applied, - : Not applied
 Option : Refer to model name in table
 1) Available from April 2020

MID STATIC

ARNU28GM2A4 / ARNU36GM2A4
 ARNU42GM2A4 / ARNU48GM3A4
 ARNU54GM3A4



Model	Unit	ARNU28GM2A4	ARNU36GM2A4	ARNU42GM2A4	ARNU48GM3A4	ARNU54GM3A4	
Cooling Capacity	kW	8.2	10.6	12.3	14.1	15.8	
Heating Capacity	kW	9.2	11.9	13.8	15.9	18.0	
Power Input (H / M / L)	Nominal	W	123 / 81 / 57	184 / 123 / 81	231 / 162 / 111	172 / 105 / 65	260 / 215 / 172
	Body	mm	1,250 x 270 x 700	1,250 x 270 x 700	1,250 x 270 x 700	1,250 x 360 x 700	1,250 x 360 x 700
Dimensions (W x H x D)	Shipping	mm	1,450 x 338 x 773	1,450 x 338 x 773	1,450 x 338 x 773	1,450 x 428 x 773	1,450 x 428 x 773
	Type		Sirocco Fan	Sirocco Fan	Sirocco Fan	Sirocco Fan	Sirocco Fan
Fan	Motor Output x Number	W x No.	350 x 1	350 x 1	350 x 1	350 x 1	350 x 1
	Air Flow Rate (H / M / L)	m³/min	28.0 / 24.0 / 21.0	32.0 / 28.0 / 24.0	38.0 / 33.0 / 28.0	40.0 / 34.0 / 28.0	50.0 / 45.0 / 40.0
	External Static Pressure (High Mode)	mmAq (Pa)	6 (59)	6 (59)	6 (59)	6 (59)	6 (59)
	Air Flow Rate (H / M / L) (Standard Mode)	m³/min	28.0 / 24.0 / 21.0	32.0 / 28.0 / 24.0	38.0 / 33.0 / 28.0	40.0 / 34.0 / 28.0	50.0 / 45.0 / 40.0
	External Static Pressure (Standard Mode)	mmAq (Pa)	5 (49)	5 (49)	5 (49)	5 (49)	5 (49)
	Motor Type		BLDC	BLDC	BLDC	BLDC	BLDC
	Air Filter		Pre Filter	Pre Filter	Pre Filter	Pre Filter	Pre Filter
Pipe Connections	Liquid Side	mm (inch)	Ø9.52 (3/8)	Ø9.52 (3/8)	Ø9.52 (3/8)	Ø9.52 (3/8)	Ø9.52 (3/8)
	Gas Side	mm (inch)	Ø15.88 (5/8)	Ø15.88 (5/8)	Ø15.88 (5/8)	Ø15.88 (5/8)	Ø19.05 (3/4)
	Drain Pipe (Internal Dia.)	mm (inch)	Ø25 (1)	Ø25 (1)	Ø25 (1)	Ø25 (1)	Ø25 (1)
Weight	Body	kg	38.0	38.0	39.5	44.0	44.0
Sound Pressure Levels (H / M / L)		dB(A)	36 / 34 / 33	37 / 36 / 34	38 / 37 / 36	39 / 37 / 35	42 / 40 / 39
Sound Power Levels (H / M / L)		dB(A)	59 / 57 / 55	60 / 59 / 57	62 / 61 / 60	63 / 60 / 59	65 / 64 / 62
Power Supply		Ø, V, Hz	1, 220-240, 50	1, 220-240, 50	1, 220-240, 50	1, 220-240, 50	1, 220-240, 50
Communication Cable		mm² x No.	1.0 ~ 1.5 x 2C	1.0 ~ 1.5 x 2C	1.0 ~ 1.5 x 2C	1.0 ~ 1.5 x 2C	1.0 ~ 1.5 x 2C

Note: 1. Performance tested under EN14511
 2. Capacities are based on the following conditions
 - Cooling: Indoor temp. 27°C (80.6°F) DB / 19°C (66.2°F) WB, Outdoor temp. 35°C (95°F) DB / 24°C (75.2°F) WB, Interconnecting piping length 7.5m, Level difference of zero
 - Heating: Indoor temp. 20°C (68°F) DB / 15°C (59°F) WB, Outdoor temp. 7°C (44.6°F) DB / 6°C (42.8°F) WB, Interconnecting piping length 7.5m, Level difference of zero
 3. Due to our policy of innovation, some specifications may be changed without notification

Accessories

Chassis	ARNU28GM2A4	ARNU36GM2A4	ARNU42GM2A4	ARNU48GM3A4	ARNU54GM3A4
Drain Pump					○
Cassette Cover					-
Refrigerant Leakage Detector				PRLDNVSO	
EEV Kit				-	
Independent Power Module				PRIP0	
Robot Cleaner				-	
Pre Filter (Washable)				○	
Ion Generator				-	
CO ₂ Sensor				-	
Ventilation Kit				-	
IR Receiver				PWLRVN000	
Zone Controller				ABZCA	
Dry Contact (with additional accessory)				PDRYCB000 (1 point contact), PDRYCB300 (8 points for thermostat compatible), PDRYCB320 (Universal input ¹⁾), PDRYCB400 (2 points input), PDRYCB500 (Modbus)	
External Input (1 point)				○	
Wi-Fi				PWFMD200	

※ ○ : Applied, - : Not applied
 Option : Refer to model name in table
 1) Available from April 2020

HIGH STATIC

ARNU76GB8A4 / ARNU96GB8A4



Model	Unit	ARNU76GB8A4	ARNU96GB8A4
Cooling Capacity	kW	22.4	28.0
Heating Capacity	kW	25.2	31.5
Power Input (H / M / L)	Nominal W	765 / 500 / 500	800 / 750 / 750
Dimensions (W x H x D)	Body	1,562 x 460 x 688	1,562 x 460 x 688
	Shipping	1,806 x 537 x 825	1,806 x 537 x 825
Fan	Type	Sirocco Fan	Sirocco Fan
	Motor Output x Number	W x No.	375 x 2
	Air Flow Rate (H / M / L) (High Mode-Factory Set)	m³/min	60.0 / 50.0 / 50.0
	External Static Pressure (High Mode)	mmAq (Pa)	22 (216)
	Air Flow Rate (H / M / L) (Standard Mode)	m³/min	64.0 / 50.0 / 50.0
	External Static Pressure (Standard Mode)	mmAq (Pa)	15 (147)
	Motor Type		BLDC
Air Filter		Pre Filter	Pre Filter
Pipe Connections	Liquid Side	mm (inch)	Ø9.52 (3/8)
	Gas Side	mm (inch)	Ø19.05 (3/4)
	Drain Pipe (Internal Dia.)	mm (inch)	Ø25 (1)
Weight	kg	87.0	87.0
Power Supply	Ø, V, Hz	1, 220-240, 50	1, 220-240, 50
Communication Cable	mm² x No.	1.0 - 1.5 x 2C	1.0 - 1.5 x 2C

Note : 1. Performance tested under EN14511
 2. Capacities are based on the following conditions
 - Cooling : Indoor temp. 27°C (80.6°F) DB / 19°C (66.2°F) WB, Outdoor temp. 35°C (95°F) DB / 24°C (75.2°F) WB, Interconnecting piping length 7.5m, Level difference of zero
 - Heating : Indoor temp. 20°C (68°F) DB / 15°C (59°F) WB, Outdoor temp. 7°C (44.6°F) DB / 6°C (42.8°F) WB, Interconnecting piping length 7.5m, Level difference of zero
 3. Due to our policy of innovation, some specifications may be changed without notification

Accessories

Chassis	ARNU76GB8A4	ARNU96GB8A4
Drain Pump		○
Cassette Cover		-
Refrigerant Leakage Detector		PRLDNV50
EEV Kit		○
Independent Power Module		PRIP0
Robot Cleaner		-
Pre Filter (Washable)		○
Ion Generator		-
CO ₂ Sensor		-
Ventilation Kit		-
IR Receiver		PWLRVN000
Zone Controller		ABZCA
Dry Contact (with additional accessory)		PDRYCB000 (1 point contact), PDRYCB300 (8 points for thermostat compatible), PDRYCB320 (Universal input ¹⁾), PDRYCB400 (2 points input), PDRYCB500 (Modbus)
External Input (1 point)		○
Wi-Fi		PWFMD200

※ ○ : Applied, - : Not applied
 Option : Refer to model name in table
 1) Available from April 2020

LOW STATIC

ARNU05GL1G4 / ARNU07GL1G4
 ARNU09GL1G4



Model	Unit	ARNU05GL1G4	ARNU07GL1G4	ARNU09GL1G4
Cooling Capacity	kW	1.7	2.2	2.8
Heating Capacity	kW	1.9	2.5	3.2
Power Input (H / M / L)	Nominal W	29 / 26 / 24	31 / 28 / 24	39 / 29 / 24
Dimensions (W x H x D)	Body	700 x 190 x 700	700 x 190 x 700	700 x 190 x 700
	Shipping	862 x 255 x 781	862 x 255 x 781	862 x 255 x 781
Fan	Type	Sirocco Fan	Sirocco Fan	Sirocco Fan
	Motor Output x Number	W x No.	19 x 1	19 x 1
	Air Flow Rate (H / M / L) (High Mode-Factory Set)	m³/min	6.7 / 6.2 / 5.5	7.5 / 6.5 / 5.5
	External Static Pressure (High Mode)	mmAq (Pa)	2.54 (25)	2.54 (25)
	Air Flow Rate (H / M / L) (Standard Mode)	m³/min	6.7 / 6.2 / 5.5	7.5 / 6.5 / 5.5
	External Static Pressure (Standard Mode)	mmAq (Pa)	0 (0)	0 (0)
	Motor Type		BLDC	BLDC
Air Filter		Pre Filter	Pre Filter	Pre Filter
Pipe Connections	Liquid Side	mm (inch)	Ø6.35 (1/4)	Ø6.35 (1/4)
	Gas Side	mm (inch)	Ø12.7 (1/2)	Ø12.7 (1/2)
	Drain Pipe (Internal Dia.)	mm (inch)	Ø25 (1)	Ø25 (1)
Weight	kg	17.5	17.5	17.5
Sound Pressure Levels (H / M / L)	dB(A)	25 / 24 / 22	26 / 24 / 22	28 / 25 / 22
Sound Power Levels (H / M / L)	dB(A)	48 / 46 / 45	50 / 47 / 45	53 / 49 / 45
Power Supply	Ø, V, Hz	1, 220-240, 50	1, 220-240, 50	1, 220-240, 50
Communication Cable	mm² x No.	1.0 - 1.5 x 2C	1.0 - 1.5 x 2C	1.0 - 1.5 x 2C

Note : 1. Performance tested under EN14511
 2. Capacities are based on the following conditions
 - Cooling : Indoor temp. 27°C (80.6°F) DB / 19°C (66.2°F) WB, Outdoor temp. 35°C (95°F) DB / 24°C (75.2°F) WB, Interconnecting piping length 7.5m, Level difference of zero
 - Heating : Indoor temp. 20°C (68°F) DB / 15°C (59°F) WB, Outdoor temp. 7°C (44.6°F) DB / 6°C (42.8°F) WB, Interconnecting piping length 7.5m, Level difference of zero
 3. Due to our policy of innovation, some specifications may be changed without notification

Accessories

Chassis	ARNU05GL1G4	ARNU07GL1G4	ARNU09GL1G4
Drain Pump		○	
Cassette Cover		-	
Refrigerant Leakage Detector		PRLDNV50	
EEV Kit		PRGK024A0	
Independent Power Module		PRIP0	
Robot Cleaner		-	
Pre Filter (Washable)		○	
Ion Generator		-	
CO ₂ Sensor		-	
Ventilation Kit		-	
IR Receiver		PWLRVN000	
Zone Controller		ABZCA	
Dry Contact (with additional accessory)		PDRYCB000 (1 point contact), PDRYCB300 (8 points for thermostat compatible), PDRYCB320 (Universal input ¹⁾), PDRYCB400 (2 points input), PDRYCB500 (Modbus)	
External Input (1 point)		○	
Wi-Fi		PWFMD200	

※ ○ : Applied, - : Not applied
 Option : Refer to model name in table
 1) Available from April 2020

LOW STATIC

ARNU12GL2G4 / ARNU15GL2G4
ARNU18GL2G4



Model	Unit	ARNU12GL2G4	ARNU15GL2G4	ARNU18GL2G4
Cooling Capacity	kW	3.6	4.5	5.6
Heating Capacity	kW	4.0	5.0	6.3
Power Input (H / M / L)	Nominal	W	41 / 34 / 29	56 / 41 / 34
	W			71 / 56 / 41
Dimensions (W x H x D)	Body	mm	900 x 190 x 700	900 x 190 x 700
	Shipping	mm	1,062 x 255 x 781	1,062 x 255 x 781
Fan	Type		Sirocco Fan	Sirocco Fan
	Motor Output x Number	W x No.	19 x 1, 5 x 1	19 x 1, 5 x 1
	Air Flow Rate (H / M / L) (High Mode-Factory Set)	m³/min	10.0 / 8.5 / 7.0	12.5 / 10.0 / 8.5
	External Static Pressure (High Mode)	mmAq (Pa)	2.54 (25)	2.54 (25)
	Air Flow Rate (H / M / L) (Standard Mode)	m³/min	10.0 / 8.5 / 7.0	12.5 / 10.0 / 8.5
	External Static Pressure (Standard Mode)	mmAq (Pa)	0 (0)	0 (0)
	Motor Type		BLDC	BLDC
	Air Filter		Pre Filter	Pre Filter
Pipe Connections	Liquid Side	mm (inch)	Ø6.35 (1/4)	Ø6.35 (1/4)
	Gas Side	mm (inch)	Ø12.7 (1/2)	Ø12.7 (1/2)
	Drain Pipe (Internal Dia.)	mm (inch)	Ø25 (1)	Ø25 (1)
Weight	kg	23.0	23.0	23.0
Sound Pressure Levels (H / M / L)	dB(A)	30 / 27 / 25	33 / 30 / 28	35 / 32 / 29
Sound Power Levels (H / M / L)	dB(A)	50 / 47 / 46	54 / 51 / 47	56 / 54 / 51
Power Supply	Ø, V, Hz	1, 220-240, 50	1, 220-240, 50	1, 220-240, 50
Communication Cable	mm² x No.	1.0 - 1.5 x 2C	1.0 - 1.5 x 2C	1.0 - 1.5 x 2C

Note : 1. Performance tested under EN14511
 2. Capacities are based on the following conditions
 - Cooling : Indoor temp. 27°C (80.6°F) DB / 19°C (66.2°F) WB, Outdoor temp. 35°C (95°F) DB / 24°C (75.2°F) WB, Interconnecting piping length 7.5m, Level difference of zero
 - Heating : Indoor temp. 20°C (68°F) DB / 15°C (59°F) WB, Outdoor temp. 7°C (44.6°F) DB / 6°C (42.8°F) WB, Interconnecting piping length 7.5m, Level difference of zero
 3. Due to our policy of innovation, some specifications may be changed without notification

Accessories

Chassis	ARNU12GL2G4	ARNU15GL2G4	ARNU18GL2G4
Drain Pump		○	
Cassette Cover		-	
Refrigerant Leakage Detector		PRLDNVSO	
EEV Kit		-	
Independent Power Module		PRIP0	
Robot Cleaner		-	
Pre Filter (Washable)		○	
Ion Generator		-	
CO ₂ Sensor		-	
Ventilation Kit		-	
IR Receiver		PWLRVN000	
Zone Controller		ABZCA	
Dry Contact (with additional accessory)		PDRYCB000 (1 point contact), PDRYCB300 (8 points for thermostat compatible), PDRYCB320 (Universal input ¹⁾), PDRYCB400 (2 points input), PDRYCB500 (Modbus)	
External Input (1 point)		○	
Wi-Fi		PWFMD200	

※ ○ : Applied, - : Not applied
 Option : Refer to model name in table
 1) Available from April 2020

LOW STATIC

ARNU21GL3G4 / ARNU24GL3G4



Model	Unit	ARNU21GL3G4	ARNU24GL3G4
Cooling Capacity	kW	6.2	7.1
Heating Capacity	kW	7.0	8.0
Power Input (H / M / L)	Nominal	W	72 / 53 / 48
	W		103 / 63 / 48
Dimensions (W x H x D)	Body	mm	1,100 x 190 x 700
	Shipping	mm	1,262 x 255 x 781
Fan	Type		Sirocco Fan
	Motor Output x Number	W x No.	19 x 2
	Air Flow Rate (H / M / L) (High Mode-Factory Set)	m³/min	17.5 / 14.0 / 12.0
	External Static Pressure (High Mode)	mmAq (Pa)	2.54 (25)
	Air Flow Rate (H / M / L) (Standard Mode)	m³/min	17.5 / 14.0 / 12.0
	External Static Pressure (Standard Mode)	mmAq (Pa)	0 (0)
	Motor Type		BLDC
	Air Filter		Pre Filter
Pipe Connections	Liquid Side	mm (inch)	Ø9.52 (3/8)
	Gas Side	mm (inch)	Ø15.88 (5/8)
	Drain Pipe (Internal Dia.)	mm (inch)	Ø25 (1)
Weight	kg	27.0	27.0
Sound Pressure Levels (H / M / L)	dB(A)	35 / 29 / 28	36 / 33 / 28
Sound Power Levels (H / M / L)	dB(A)	59 / 55 / 54	63 / 59 / 55
Power Supply	Ø, V, Hz	1, 220-240, 50	1, 220-240, 50
Communication Cable	mm² x No.	1.0 - 1.5 x 2C	1.0 - 1.5 x 2C

Note : 1. Performance tested under EN14511
 2. Capacities are based on the following conditions
 - Cooling : Indoor temp. 27°C (80.6°F) DB / 19°C (66.2°F) WB, Outdoor temp. 35°C (95°F) DB / 24°C (75.2°F) WB, Interconnecting piping length 7.5m, Level difference of zero
 - Heating : Indoor temp. 20°C (68°F) DB / 15°C (59°F) WB, Outdoor temp. 7°C (44.6°F) DB / 6°C (42.8°F) WB, Interconnecting piping length 7.5m, Level difference of zero
 3. Due to our policy of innovation, some specifications may be changed without notification

Accessories

Chassis	ARNU21GL3G4	ARNU24GL3G4
Drain Pump		○
Cassette Cover		-
Refrigerant Leakage Detector		PRLDNVSO
EEV Kit		PRGK024A0
Independent Power Module		PRIP0
Robot Cleaner		-
Pre Filter (Washable)		○
Ion Generator		-
CO ₂ Sensor		-
Ventilation Kit		-
IR Receiver		PWLRVN000
Zone Controller		ABZCA
Dry Contact (with additional accessory)		PDRYCB000 (1 point contact), PDRYCB300 (8 points for thermostat compatible), PDRYCB320 (Universal input ¹⁾), PDRYCB400 (2 points input), PDRYCB500 (Modbus)
External Input (1 point)		○
Wi-Fi		PWFMD200

※ ○ : Applied, - : Not applied
 Option : Refer to model name in table
 1) Available from April 2020

HIGH SENSIBLE

ARNU07GM2A4 / ARNU09GM2A4
 ARNU12GM2A4 / ARNU15GM2A4
 ARNU18GM3A4



Model	Unit	ARNU07GM2A4	ARNU09GM2A4	ARNU12GM2A4	ARNU15GM2A4	ARNU18GM3A4	
Cooling Capacity	kW	2.2	2.8	3.6	4.5	5.6	
Heating Capacity	kW	2.5	3.2	4.0	5.0	6.3	
Power Input (H / M / L)	W	32 / 29 / 27	32 / 29 / 27	33 / 30 / 28	33 / 30 / 28	97 / 70 / 51	
Dimensions (W x H x D)	Body	mm	1,250 x 270 x 700	1,250 x 270 x 700	1,250 x 270 x 700	1,250 x 360 x 700	
	Type		Sirocco Fan	Sirocco Fan	Sirocco Fan	Sirocco Fan	
Motor Output x Number	W x No.	350 x 1	350 x 1	350 x 1	350 x 1	500 x 1	
Fan	Air Flow Rate (H / M / L) (High static Mode - factory set)	m³/min	13.3 / 9.4 / 6.8	13.3 / 9.4 / 6.8	14.8 / 10.2 / 7.4	14.8 / 10.2 / 7.4	32.7 / 26.7 / 23.0
	External Static Pressure	mmAq (Pa)	6 (59)	6 (59)	6 (59)	6 (59)	6 (59)
	Air Flow Rate (H / M / L) (Standard Mode)	m³/min	13.3 / 9.4 / 6.8	13.3 / 9.4 / 6.8	14.8 / 10.2 / 7.4	14.8 / 10.2 / 7.4	32.7 / 26.7 / 23.0
	External Static Pressure	mmAq (Pa)	5 (49)	5 (49)	5 (49)	5 (49)	5 (49)
	Motor type		BLDC	BLDC	BLDC	BLDC	BLDC
Air Filter		-	-	-	-	-	
Pipe Connections	Liquid Side	mm (inch)	Ø9.52 (3/8)	Ø9.52 (3/8)	Ø9.52 (3/8)	Ø9.52 (3/8)	
	Gas Side	mm (inch)	Ø15.88 (5/8)	Ø15.88 (5/8)	Ø15.88 (5/8)	Ø15.88 (5/8)	
	Drain Pipe (Internal Dia.)	mm (inch)	25 (1)	25 (1)	25 (1)	25 (1)	
Net Weight	kg	38	38	38	38	44	
Sound Pressure Levels (H / M / L)	dB(A)	33 / 33 / 32	33 / 33 / 32	34 / 33 / 32	34 / 33 / 32	38 / 36 / 34	
Sound Power Levels (H / M / L)	dB(A)	52 / 52 / 52	52 / 52 / 52	53 / 52 / 52	53 / 52 / 52	52 / 51 / 50	
Power Supply	Ø, V, Hz	1, 220-240, 50	1, 220-240, 50	1, 220-240, 50	1, 220-240, 50	1, 220-240, 50	
Transmission cable	mm²	1.0 - 1.5 x 2C	1.0 - 1.5 x 2C	1.0 - 1.5 x 2C	1.0 - 1.5 x 2C	1.0 - 1.5 x 2C	

- Note : 1. Due to our policy of innovation some specifications may be changed without notification.
 2. Wiring cable size must comply with the applicable local and national code. And "Electric characteristics" chapter should be considered for electrical work and design. Especially the power cable and circuit breaker should be selected in accordance with that.
 3. Sound pressure level is measured on the rated condition in the anechoic rooms by ISO 3745 standard. Sound power level is measured on the rated condition in the reverberation rooms by ISO 3741 standard. Therefore, these values can be increased owing to ambient conditions during operation.
 4. Capacities are net capacities and based on the following conditions. Refer to the Outdoor Unit Specifications for calculating the real capacity.
 - Cooling : Indoor Ambient Temp. 27°CDB / 19°CWB, Outdoor Ambient Temp. 35°CDB / 24°CWB
 - Heating : Indoor Ambient Temp. 20°CDB / 15°CWB, Outdoor Ambient Temp. 7°CDB / 6°CWB
 - Interconnected Pipe is standard length and difference of Elevation (Outdoor - Indoor Unit) is Zero.
 5. Sound levels are measured at 50Pa External Static Pressure condition.
 6. * : Air flow rate could be different in accordance with External Static Pressure and setting value.

Accessories

Chassis	ARNU07GM2A4	ARNU09GM2A4	ARNU12GM2A4	ARNU15GM2A4	ARNU18GM3A4
Drain Pump			○		
Cassette Cover			-		
Refrigerant Leakage Detector			PRLDNVSO		
EEV Kit			-		
Independent Power Module			PRIP0		
Robot Cleaner			-		
Pre Filter (Washable)			○		
Ion Generator			-		
CO ₂ Sensor			-		
Ventilation Kit			-		
IR Receiver			PWLRVN000		
Zone Controller			ABZCA		
Dry Contact (with additional accessory)			PDRYCB000 (1 point contact), PDRYCB300 (8 points for thermostat compatible), PDRYCB320 (Universal input ¹⁾), PDRYCB400 (2 points input), PDRYCB500 (Modbus)		
External Input (1 point)			○		
Wi-Fi			PWFMD200		

- ※ ○ : Applied, - : Not applied
 Option : Refer to model name in table
 1) Available from April 2020

HIGH SENSIBLE

ARNU24GM3A4 / ARNU28GM3A4
 ARNU36GB8A4 / ARNU42GB8A4
 ARNU48GB8A4



Model	Unit	ARNU24GM3A4	ARNU28GM3A4	ARNU36GB8A4	ARNU42GB8A4	ARNU48GB8A4	
Cooling Capacity	kW	7.1	8.2	10.6	12.3	14.1	
Heating Capacity	kW	8.0	9.2	11.9	13.8	15.9	
Power Input (H / M / L)	W	109 / 83 / 60	109 / 83 / 60	420 / 403 / 478	528 / 497 / 465	538 / 505 / 482	
Dimensions (W x H x D)	Body	mm	1,250 x 360 x 700	1,250 x 360 x 700	1,562 x 460 x 688	1,562 x 460 x 688	
	Type		Sirocco Fan	Sirocco Fan	Sirocco Fan	Sirocco Fan	
Motor Output x Number	W x No.	500 x 1	500 x 1	375 x 2	375 x 2	375 x 2	
Fan	Air Flow Rate (H / M / L) (High static Mode - factory set)	m³/min	35.5 / 30.6 / 26.2	35.5 / 30.6 / 26.2	49.0 / 37.3 / 30.2	54.2 / 41.3 / 31.8	57.2 / 43.0 / 34.0
	External Static Pressure	mmAq (Pa)	6 (59)	6 (59)	18 (176)	18 (176)	18 (176)
	Air Flow Rate (H / M / L) (Standard Mode)	m³/min	35.5 / 30.6 / 26.2	35.5 / 30.6 / 26.2	53.7 / 49.5 / 43.9	55.6 / 50.6 / 45.0	58.0 / 52.3 / 47.3
	External Static Pressure	mmAq (Pa)	5 (49)	5 (49)	9 (88)	9 (88)	9 (88)
	Motor type		BLDC	BLDC	BLDC	BLDC	BLDC
Air Filter		-	-	-	-	-	
Pipe Connections	Liquid Side	mm (inch)	Ø9.52 (3/8)	Ø9.52 (3/8)	Ø9.52 (3/8)	Ø9.52 (3/8)	
	Gas Side	mm (inch)	Ø15.88 (5/8)	Ø15.88 (5/8)	Ø19.05 (3/4)	Ø19.05 (3/4)	
	Drain Pipe (Internal Dia.)	mm (inch)	25 (1)	25 (1)	25 (1)	25 (1)	
Net Weight	kg	44	44	87	87	87	
Sound Pressure Levels (H / M / L)	dB(A)	39 / 37 / 35	39 / 37 / 35	46 / 45 / 42	47 / 46 / 43	47 / 46 / 44	
Sound Power Levels (H / M / L)	dB(A)	53 / 52 / 51	53 / 52 / 51	65 / 64 / 62	66 / 65 / 63	66 / 65 / 64	
Power Supply	Ø, V, Hz	1, 220-240, 50	1, 220-240, 50	1, 220-240, 50	1, 220-240, 50	1, 220-240, 50	
Transmission cable	mm²	1.0 - 1.5 x 2C	1.0 - 1.5 x 2C	1.0 - 1.5 x 2C	1.0 - 1.5 x 2C	1.0 - 1.5 x 2C	

- Note : 1. Due to our policy of innovation some specifications may be changed without notification.
 2. Wiring cable size must comply with the applicable local and national code. And "Electric characteristics" chapter should be considered for electrical work and design. Especially the power cable and circuit breaker should be selected in accordance with that.
 3. Sound pressure level is measured on the rated condition in the anechoic rooms by ISO 3745 standard. Sound power level is measured on the rated condition in the reverberation rooms by ISO 3741 standard. Therefore, these values can be increased owing to ambient conditions during operation.
 4. Capacities are net capacities and based on the following conditions. Refer to the Outdoor Unit Specifications for calculating the real capacity.
 - Cooling : Indoor Ambient Temp. 27°CDB / 19°CWB, Outdoor Ambient Temp. 35°CDB / 24°CWB
 - Heating : Indoor Ambient Temp. 20°CDB / 15°CWB, Outdoor Ambient Temp. 7°CDB / 6°CWB
 - Interconnected Pipe is standard length and difference of Elevation (Outdoor - Indoor Unit) is Zero.
 5. Sound levels are measured at 50Pa External Static Pressure condition.
 6. * : Air flow rate could be different in accordance with External Static Pressure and setting value.

Accessories

Chassis	ARNU24GM3A4	ARNU28GM3A4	ARNU36GB8A4	ARNU42GB8A4	ARNU48GB8A4
Drain Pump			○		
Cassette Cover			-		
Refrigerant Leakage Detector			PRLDNVSO		
EEV Kit			-		
Independent Power Module			PRIP0		
Robot Cleaner			-		
Pre Filter (Washable)			○		
Ion Generator			-		
CO ₂ Sensor			-		
Ventilation Kit			-		
IR Receiver			PWLRVN000		
Zone Controller			ABZCA		
Dry Contact (with additional accessory)			PDRYCB000 (1 point contact), PDRYCB300 (8 points for thermostat compatible), PDRYCB320 (Universal input ¹⁾), PDRYCB400 (2 points input), PDRYCB500 (Modbus)		
External Input (1 point)			○		
Wi-Fi			PWFMD200		

- ※ ○ : Applied, - : Not applied
 Option : Refer to model name in table
 1) Available from April 2020

FRESH AIR INTAKE

Fresh Outdoor Air Supply

The LG Fresh Air Intake Unit (FAU) is the alternative solution for ventilation, which supplies the fresh outdoor air indoors as well as being able to cool and heat air inside simultaneously. It means the indoor space can have positive air pressure consistently, which can block cold, hot or contaminated air from outside. This allows the indoor space to have consistent positive air pressure blocking cold.

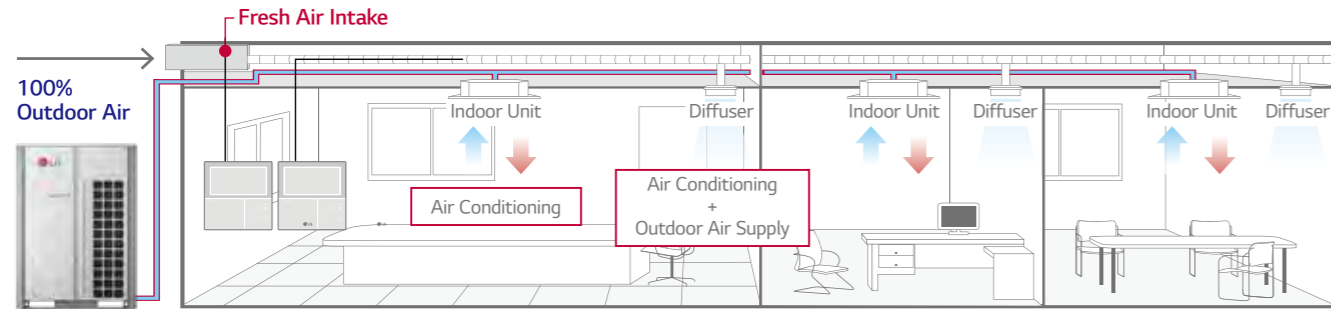

MULTI V 5 Outdoor Unit

Economic Operation

Natural outdoor air is utilized as seasons change for cost efficiency.

Spring Season

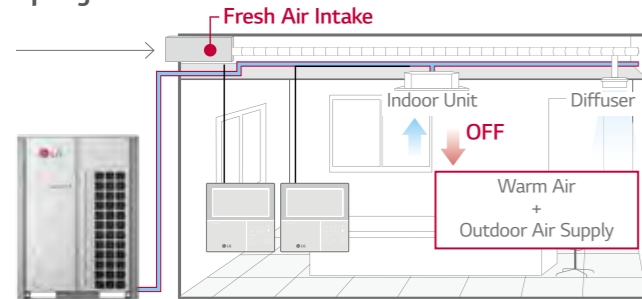

MULTI V 5 Outdoor Unit

Autumn Season

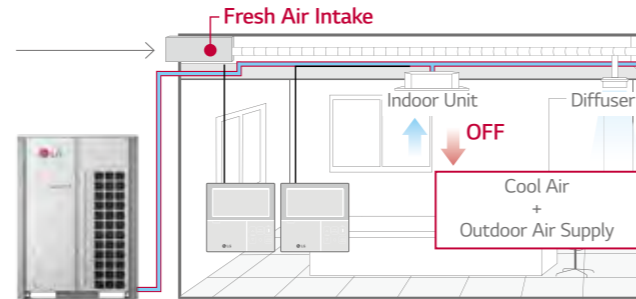

MULTI V 5 Outdoor Unit

Installation Scene

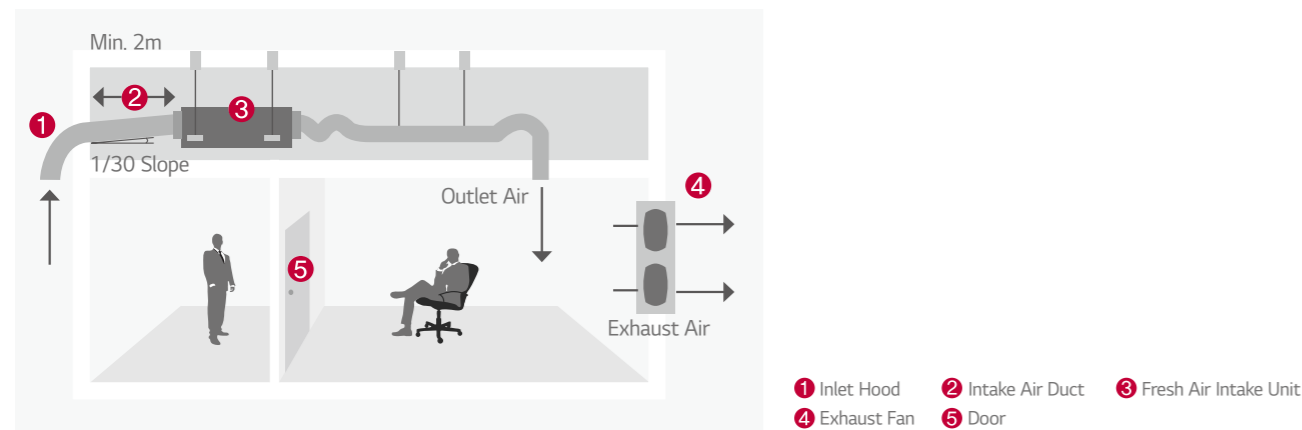

- 1 Inlet Hood
- 2 Intake Air Duct
- 3 Fresh Air Intake Unit
- 4 Exhaust Fan
- 5 Door

FRESH AIR INTAKE

ARNU76GB8Z4 / ARNU96GB8Z4



Model	Unit	ARNU76GB8Z4	ARNU96GB8Z4	
Cooling Capacity	kW	22.4	28.0	
Heating Capacity	kW	21.4	26.7	
Power Input (H / M / L)	Nominal W	230 / 200 / 200	360 / 230 / 230	
Dimensions (W x H x D)	Body mm	1,562 x 460 x 688	1,562 x 460 x 688	
	Shipping mm	1,806 x 537 x 825	1,806 x 537 x 825	
Fan	Type	Sirocco Fan	Sirocco Fan	
	Motor Output x Number	W x No.	375 x 1	
	Air Flow Rate (H / M / L) (High Mode-Factory Set)	m ³ /min	23.7 / 13.2 / 13.2	35.7 / 23.7 / 23.7
	External Static Pressure	mmAq (Pa)	22 (216)	22 (216)
	Motor Type		BLDC	BLDC
Air Filter		Long Life Filter		
	Liquid Side	mm (inch)	Ø9.52 (3/8)	
Pipe Connections	Gas Side	mm (inch)	Ø19.05 (3/4)	
	Drain Pipe (Internal Dia.)	mm (inch)	Ø25 (1)	
Weight	Body kg	73.0	73.0	
Sound Pressure Levels (H / M / L)	dB(A)	45 / 43 / 43	47 / 45 / 45	
Sound Power Levels (H / M / L)	dB(A)	70 / 67 / 67	72 / 70 / 70	
Power Supply	Ø, V, Hz	1, 220-240, 50	1, 220-240, 50	
Communication Cable	mm ² x No.	1.0 - 1.5 x 2C	1.0 - 1.5 x 2C	

Note : 1. Performance tested under EN14511
 2. Capacities are based on the following conditions
 - Cooling : Indoor temp. 27°C (80.6°F) DB / 19°C (66.2°F) WB, Outdoor temp. 35°C (95°F) DB / 24°C (75.2°F) WB, Interconnecting piping length 7.5m, Level difference of zero
 - Heating : Indoor temp. 20°C (68°F) DB / 15°C (59°F) WB, Outdoor temp. 7°C (44.6°F) DB / 6°C (42.8°F) WB, Interconnecting piping length 7.5m, Level difference of zero
 3. Due to our policy of innovation, some specifications may be changed without notification

CAUTION		
1. Operation range (Cooling : 5°C ~ 43°C, Heating : -5°C ~ 43°C) 2. Installation of exhaust fan is recommended for a sealed room. 3. Indoor Unit Connection		
No	Connection Condition	Combination
1	Fresh air intake units only are connected with outdoor units	1) The total capacity of fresh air intake unit should be 50 ~ 100% of outdoor unit. 2) The max quantity of fresh air intake is 4 units.
2	Mixture connection with general indoor unit and fresh intake units	1) The total capacity of indoor units (Standard Indoor Unit + Fresh Air Intake Unit) should be 50 ~ 100% of outdoor unit. 2) The total capacity of fresh air intake unit should be less than 30% of the total capacity of indoor units.

Accessories

Chassis	ARNU76GB8Z4	ARNU96GB8Z4
Drain Pump		○
Cassette Cover		-
Refrigerant Leakage Detector		PRLDNVSO
EEV Kit		-
Independent Power Module		PRIP0
Robot Cleaner		-
Pre Filter (Washable)		○
Ion Generator		-
CO ₂ Sensor		-
Ventilation Kit		-
IR Receiver		PWLRVN000
Zone Controller		-
Dry Contact (with additional accessory)		PDRYCB000 (1 point contact), PDRYCB300 (8 points for thermostat compatible), PDRYCB320 (Universal input ¹⁾), PDRYCB400 (2 points input), PDRYCB500 (Modbus)
External Input (1 point)		○
Wi-Fi		PWFMD200

※ ○ : Applied, - : Not applied
 Option : Refer to model name in table
 1) Available from April 2020

CEILING & FLOOR CONVERTIBLE CEILING SUSPENDED



Features & Benefits

- Modern design with V-shape and black vane
- Powerful air speed and volume can reach up to 15m

Key Applications

- Retail
- Shop
- Restaurant

	Ceilings	Ceiling & Floor Convertible	Ceiling Suspended
Smart	Wi-Fi	○	○
Fast Cooling & Heating	Jet Cool	○	○
	Sleep mode	○	○
	Timer (On / Off)	○	○
Comfort	Timer (Weekly)	○	○
	Two thermistor control	○	○
	Group control	○	○

※ ○ : Applied, - : Not applied

SMART

Wi-Fi Control

Access your air conditioner anytime and from anywhere.



LG ThinQ

Search "LG ThinQ" on Google market or Appstore then download the app.

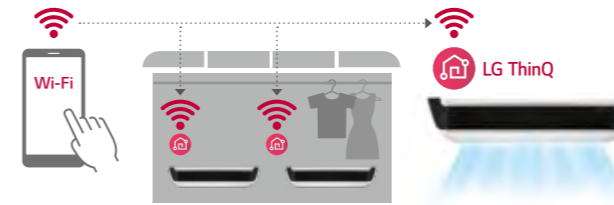

Easy Registration and Log-in

Follow the easy set-up steps that will activate LG ThinQ's impressive feature.

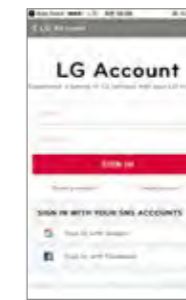

COMFORT (CONVERTIBLE)

Flexible

The ceiling and floor models can be installed either on the ceiling or on the floor.



Air flow Direction Control

Vertical air flow direction can be adjusted using remote controller, and horizontal Air flow direction can be adjusted manually.

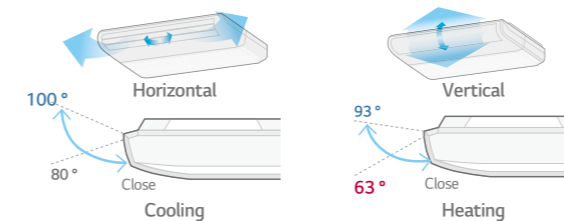

Filter Change Alarm

The filter change alarm informs you when the unit has been operating for 2,400 hours.



One Touch Filter

Filter Change Alarm

COMFORT (CEILING SUSPENDED)

Differentiated Design

Modern elegance design with V-shape and black vane is appropriate for any commercial space. It received iF Design Award.



Powerful Cooling & Heating

High ceiling mode provides powerful cooling and heating up to 4.2m in height from floor, 15m away from ceiling.



One Touch & 2 Piece Filter

Easy in / out filter structure as well as a simplified two-piece filter, which slides out for easy cleaning and maintenance.

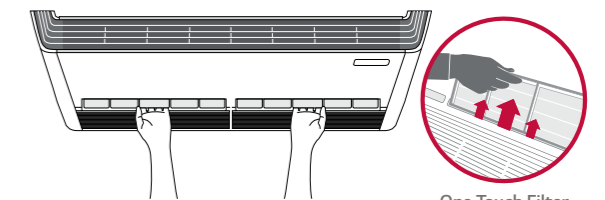

One Touch Filter

Two Thermistors Control

Users can purchase a wired remote controller that includes a second thermistor, allowing for temperature checks from multiple locations.



CEILING & FLOOR CONVERTIBLE

ARNU09GVEA4 / ARNU12GVEA4



Model	Unit	ARNU09GVEA4	ARNU12GVEA4
Cooling Capacity	kW	2.8	3.6
Heating Capacity	kW	3.2	4.0
Power Input (H / M / L)	Nominal W	19 / 15 / 11	28 / 19 / 15
Exterior Color		Morning Fog	Morning Fog
RAL Code		RAL 9001	RAL 9001
Dimensions (W x H x D)	Body mm	900 x 490 x 200	900 x 490 x 200
	Shipping mm	975 x 279 x 562	975 x 279 x 562
	Type	Cross Flow Fan	Cross Flow Fan
Fan	Motor Output x Number W x No.	27 x 1	27 x 1
	Air Flow Rate (H / M / L) m³/min	7.6 / 6.9 / 6.2	9.2 / 7.6 / 6.9
		cfm	268 / 244 / 219
	Motor Type	BLDC	BLDC
Air Filter		Pre Filter	Pre Filter
Pipe Connections	Liquid Side mm (inch)	Ø6.35 (1/4)	Ø6.35 (1/4)
	Gas Side mm (inch)	Ø12.7 (1/2)	Ø12.7 (1/2)
	Drain Pipe (Internal Dia.) mm (inch)	Ø16 (5/8)	Ø16 (5/8)
Weight	Body kg	13.3	13.3
Sound Pressure Levels (H / M / L)	dB(A)	36 / 32 / 28	38 / 36 / 30
Sound Power Levels (H / M / L)	dB(A)	55 / 51 / 45	56 / 55 / 49
Power Supply	Ø, V, Hz	1, 220-240, 50	1, 220-240, 50
Communication Cable	mm² x No.	1.0 - 1.5 x 2C	1.0 - 1.5 x 2C

Note : 1. Performance tested under EN14511
 2. Capacities are based on the following conditions
 - Cooling : Indoor temp. 27°C (80.6°F) DB / 19°C (66.2°F) WB, Outdoor temp. 35°C (95°F) DB / 24°C (75.2°F) WB, Interconnecting piping length 7.5m, Level difference of zero
 - Heating : Indoor temp. 20°C (68°F) DB / 15°C (59°F) WB, Outdoor temp. 7°C (44.6°F) DB / 6°C (42.8°F) WB, Interconnecting piping length 7.5m, Level difference of zero
 3. Due to our policy of innovation, some specifications may be changed without notification

Accessories

Chassis	ARNU09GVEA4	ARNU12GVEA4
Drain Pump	-	-
Refrigerant Leakage Detector	-	-
EEV Kit	-	PRLDNVSO
Independent Power Module	-	PRGK024A0
Plasma Kit	-	PRIP0
Robot Cleaner	-	-
Pre Filter (Washable)	-	○
Ion Generator	-	-
CO ₂ Sensor	-	-
Ventilation Kit	-	-
IR Receiver	-	-
Zone Controller	-	-
Dry Contact (with additional accessory)	PDRYCB000 (1 point contact), PDRYCB300 (8 points for thermostat compatible), PDRYCB320 (Universal input ¹⁾), PDRYCB400 (2 points input), PDRYCB500 (Modbus)	
External Input (1 point)	○	
Wi-Fi	PWFMD200 ¹⁾	

※ ○ : Applied, - : Not Applied
 Option: Refer to model name in table
 1) Available from April 2020

CEILING SUSPENDED

ARNU18GV1A4 / ARNU24GV1A4
 ARNU36GV2A4 / ARNU48GV2A4



Model	Unit	ARNU18GV1A4	ARNU24GV1A4	ARNU36GV2A4	ARNU48GV2A4
Cooling Capacity	kW	5.6	7.1	10.6	14.1
Heating Capacity	kW	6.3	8.0	11.9	15.9
Power Input (H / M / L)	Nominal W	23 / 20 / 17	25 / 21 / 17	84 / 77 / 66	91 / 79 / 66
Exterior Color		Morning Fog	Morning Fog	Morning Fog	Morning Fog
RAL Code		RAL 9001	RAL 9001	RAL 9001	RAL 9001
Dimensions (W x H x D)	Body mm	1,200 x 235 x 690	1,200 x 235 x 690	1,600 x 235 x 690	1,600 x 235 x 690
	Shipping mm	1,315 x 320 x 772	1,315 x 320 x 772	1,715 x 320 x 772	1,715 x 320 x 772
	Type	Cross Flow Fan	Cross Flow Fan	Cross Flow Fan	Cross Flow Fan
Fan	Motor Output x Number W x No.	85.9 x 1	85.9 x 1	125 x 1	125 x 1
	Air Flow Rate (H / M / L) m³/min	13.5 / 12.5 / 12.0	14.0 / 13.0 / 12.0	27.0 / 24.0 / 20.0	29.0 / 24.0 / 20.0
	Motor Type	BLDC	BLDC	BLDC	BLDC
Air Filter		Pre Filter	Pre Filter	Pre Filter	Pre Filter
Pipe Connections	Liquid Side mm (inch)	Ø6.35 (1/4)	Ø9.52 (3/8)	Ø9.52 (3/8)	Ø9.52 (3/8)
	Gas Side mm (inch)	Ø12.7 (1/2)	Ø15.88 (5/8)	Ø15.88 (5/8)	Ø15.88 (5/8)
	Drain Pipe (Internal Dia.) mm (inch)	Ø16 (5/8)	Ø16 (5/8)	Ø16 (5/8)	Ø16 (5/8)
Weight	Body kg	29.0	29.0	37.0	37.0
Sound Pressure Levels (H / M / L)	dB(A)	36 / 34 / 33	37 / 35 / 33	48 / 46 / 44	49 / 47 / 44
Sound Power Levels (H / M / L)	dB(A)	61 / 59 / 56	62 / 59 / 56	68 / 66 / 64	68 / 67 / 66
Power Supply	Ø, V, Hz	1, 220-240, 50	1, 220-240, 50	1, 220-240, 50	1, 220-240, 50
Communication Cable	mm² x No.	1.0 - 1.5 x 2C	1.0 - 1.5 x 2C	1.0 - 1.5 x 2C	1.0 - 1.5 x 2C

Note : 1. Performance tested under EN14511
 2. Capacities are based on the following conditions
 - Cooling : Indoor temp. 27°C (80.6°F) DB / 19°C (66.2°F) WB, Outdoor temp. 35°C (95°F) DB / 24°C (75.2°F) WB, Interconnecting piping length 7.5m, Level difference of zero
 - Heating : Indoor temp. 20°C (68°F) DB / 15°C (59°F) WB, Outdoor temp. 7°C (44.6°F) DB / 6°C (42.8°F) WB, Interconnecting piping length 7.5m, Level difference of zero
 3. Due to our policy of innovation, some specifications may be changed without notification

Accessories

Chassis	ARNU18GV1A4	ARNU24GV1A4	ARNU36GV2A4	ARNU48GV2A4
Drain Pump	-	-	-	-
Cassette Cover	-	-	-	-
Refrigerant Leakage Detector	-	-	PRLDNVSO	-
EEV Kit	-	-	-	-
Independent Power Module	-	-	PRIP0	-
Robot Cleaner	-	-	-	-
Pre Filter (Washable)	-	-	○	-
Ion Generator	-	-	-	-
CO ₂ Sensor	-	-	-	-
Ventilation Kit	-	-	-	-
IR Receiver	-	-	-	-
Zone Controller	-	-	-	-
Dry Contact (with additional accessory)	PDRYCB000 (1 point contact), PDRYCB300 (8 points for thermostat compatible), PDRYCB320 (Universal input ¹⁾), PDRYCB400 (2 points input), PDRYCB500 (Modbus)			
External Input (1 point)	○			
Wi-Fi	PWFMD200			

※ ○ : Applied, - : Not Applied
 Option: Refer to model name in table
 1) Available from April 2020

CONSOLE & FLOOR STANDING



Features & Benefits

- 6 way flexible piping
- Cold draft window protection
- Condensation protection

Key Applications

- Residential building
- Hotel
- Historical building

	Floor standing	Console	Floor Standing
Smart	Wi-Fi	○	○
Energy Efficiency	Jet Cool	-	○
Health	Ionizer	○	-
Fast Cooling & Heating	Jet Cool	○	-
Comfort	Sleep Mode	○	○
	Timer (On / Off)	○	○
	Timer (Weekly)	○	○
	Two Thermistor Control	○	○
	Group Control	○	○

※ ○ : Applied, - : Not applied

SMART

Wi-Fi Control

Access your air conditioner anytime and from anywhere.

LG ThinQ
 Search "LG ThinQ" on Google market or Appstore then download the app.

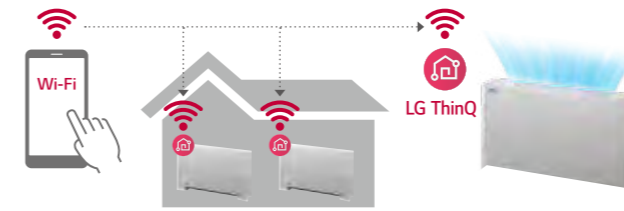

COMFORT (CONSOLE)

Air Flow Direction Change

During the cooling operation, the vane adjusts upwards to direct the air flow towards the ceiling. When heating, the vane directs the warm air downwards to balance the room temperature especially for floor.

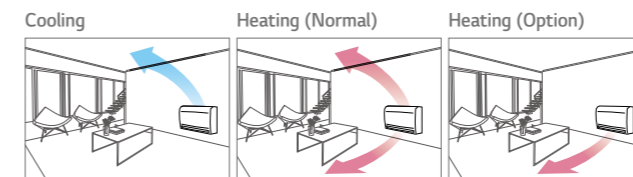

Cold Draft Protection

The console protects cold draft from windows to provide comfortable environment.

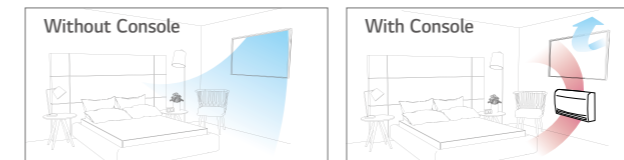

5-Step Vane Control

There are 5 different stages to control air flow direction.

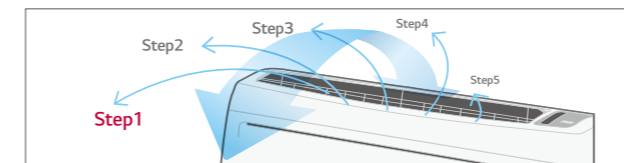

6 Way Flexible Piping

It is possible to install and connect the outdoor unit in 6 different ways. (Right Side, Right Back, Right Floor, Left Side, Left Back, Left Floor)

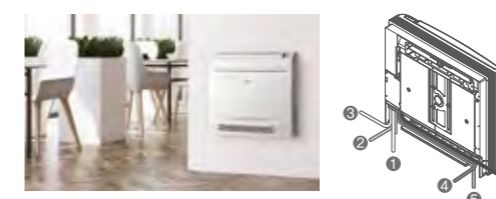

COMFORT (FLOOR STANDING)

Protect Cold Draft

The floor standing unit protects cold draft coming from window and preventing condensation.

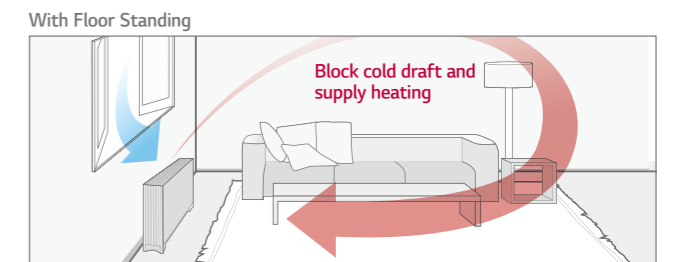
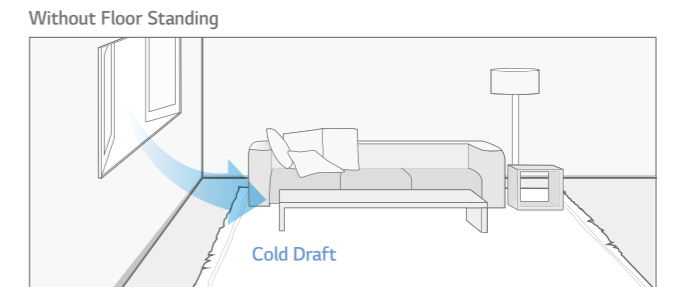

3 Way Flexible Piping

It is possible to install and connect the outdoor unit in 3 different ways (Side, Back, Floor).

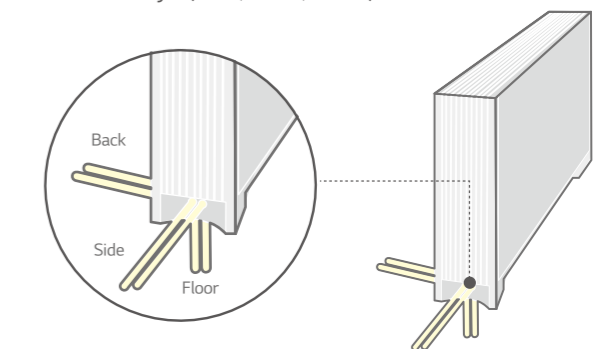

Sliding Type Filter

Easy maintenance and extended product life with sliding type filter.

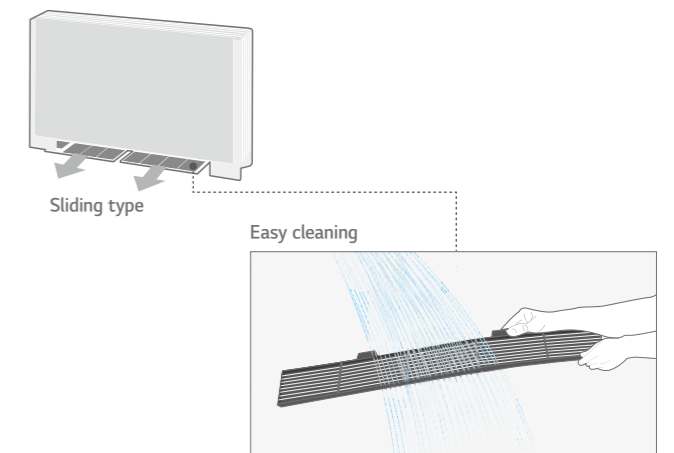

CONSOLE

ARNU07GQAA4 / ARNU09GQAA4



Model	Unit	ARNU07GQAA4	ARNU09GQAA4
Cooling Capacity	kW	2.2	2.8
Heating Capacity	kW	2.5	3.2
Power Input (H / M / L)	Nominal W	15 / 12 / 10	15 / 12 / 10
Exterior Color		Morning Fog	Morning Fog
RAL Code		RAL 9001	RAL 9001
Dimensions (W x H x D)	Body mm	700 x 600 x 210	700 x 600 x 210
	Shipping mm	775 x 662 x 284	775 x 662 x 284
	Type	Turbo fan	Turbo fan
Fan	Motor Output x Number W x No.	48 x 1	48 x 1
	Air Flow Rate (H / M / L) m³/min	6.7 / 5.9 / 4.8	6.7 / 5.9 / 4.8
	Motor Type	BLDC	BLDC
Air Filter		Pre Filter	Pre Filter
Pipe Connections	Liquid Side mm (inch)	Ø6.35 (1/4)	Ø6.35 (1/4)
	Gas Side mm (inch)	Ø12.7 (1/2)	Ø12.7 (1/2)
	Drain Pipe (Internal Dia.) mm (inch)	Ø12 (15/32)	Ø12 (15/32)
Weight	Body kg	14.0	14.0
Sound Pressure Levels (H / M / L)	dB(A)	37 / 34 / 28	37 / 34 / 28
Sound Power Levels (H / M / L)	dB(A)	53 / 50 / 44	53 / 50 / 44
Power Supply	Ø, V, Hz	1, 220-240, 50	1, 220-240, 50
Communication Cable	mm² x No.	1.0 ~ 1.5 x 2C	1.0 ~ 1.5 x 2C

Note : 1. Performance tested under EN14511
 2. Capacities are based on the following conditions
 - Cooling : Indoor temp. 27°C (80.6°F) DB / 19°C (66.2°F) WB, Outdoor temp. 35°C (95°F) DB / 24°C (75.2°F) WB, Interconnecting piping length 7.5m, Level difference of zero
 - Heating : Indoor temp. 20°C (68°F) DB / 15°C (59°F) WB, Outdoor temp. 7°C (44.6°F) DB / 6°C (42.8°F) WB, Interconnecting piping length 7.5m, Level difference of zero
 3. Due to our policy of innovation, some specifications may be changed without notification

Accessories

Chassis	ARNU07GQAA4	ARNU09GQAA4
Drain Pump	-	-
Cassette Cover	-	-
Refrigerant Leakage Detector	PRLDNV50	
EEV Kit	PRGK024A0	
Independent Power Module	PRIPO	
Robot Cleaner	-	-
Pre Filter (Washable)	○	
Ion Generator	○	
CO ₂ Sensor	-	-
Ventilation Kit	-	-
IR Receiver	-	-
Zone Controller	-	-
Dry Contact (with additional accessory)	PDRYCB000 (1 point contact), PDRYCB300 (8 points for thermostat compatible), PDRYCB320 (Universal input ¹⁾), PDRYCB400 (2 points input), PDRYCB500 (Modbus)	
External Input (1 point)	○	
Wi-Fi	PWFMD200	

※ ○ : Applied, - : Not Applied
 Option: Refer to model name in table
 1) Available from April 2020

CONSOLE

ARNU12GQAA4 / ARNU15GQAA4



Model	Unit	ARNU12GQAA4	ARNU15GQAA4
Cooling Capacity	kW	3.6	4.5
Heating Capacity	kW	4.0	5.0
Power Input (H / M / L)	Nominal W	18 / 15 / 13	24 / 19 / 17
Exterior Color		Morning Fog	Morning Fog
RAL Code		RAL 9001	RAL 9001
Dimensions (W x H x D)	Body mm	700 x 600 x 210	700 x 600 x 210
	Shipping mm	775 x 662 x 284	775 x 662 x 284
	Type	Turbo fan	Turbo fan
Fan	Motor Output x Number W x No.	48 x 1	48 x 1
	Air Flow Rate (H / M / L) m³/min	7.5 / 5.9 / 4.8	8.7 / 6.7 / 5.9
	Motor Type	BLDC	BLDC
Air Filter		Pre Filter	Pre Filter
Pipe Connections	Liquid Side mm (inch)	Ø6.35 (1/4)	Ø6.35 (1/4)
	Gas Side mm (inch)	Ø12.7 (1/2)	Ø12.7 (1/2)
	Drain Pipe (Internal Dia.) mm (inch)	Ø12 (15/32)	Ø12 (15/32)
Weight	Body kg	14.0	14.0
Sound Pressure Levels (H / M / L)	dB(A)	39 / 34 / 28	42 / 37 / 31
Sound Power Levels (H / M / L)	dB(A)	56 / 50 / 44	58 / 53 / 50
Power Supply	Ø, V, Hz	1, 220-240, 50	1, 220-240, 50
Communication Cable	mm² x No.	1.0 ~ 1.5 x 2C	1.0 ~ 1.5 x 2C

Note : 1. Performance tested under EN14511
 2. Capacities are based on the following conditions
 - Cooling : Indoor temp. 27°C (80.6°F) DB / 19°C (66.2°F) WB, Outdoor temp. 35°C (95°F) DB / 24°C (75.2°F) WB, Interconnecting piping length 7.5m, Level difference of zero
 - Heating : Indoor temp. 20°C (68°F) DB / 15°C (59°F) WB, Outdoor temp. 7°C (44.6°F) DB / 6°C (42.8°F) WB, Interconnecting piping length 7.5m, Level difference of zero
 3. Due to our policy of innovation, some specifications may be changed without notification

Accessories

Chassis	ARNU12GQAA4	ARNU15GQAA4
Drain Pump	-	-
Cassette Cover	-	-
Refrigerant Leakage Detector	PRLDNV50	
EEV Kit	PRGK024A0	
Independent Power Module	PRIPO	
Robot Cleaner	-	-
Pre Filter (Washable)	○	
Ion Generator	○	
CO ₂ Sensor	-	-
Ventilation Kit	-	-
IR Receiver	-	-
Zone Controller	-	-
Dry Contact (with additional accessory)	PDRYCB000 (1 point contact), PDRYCB300 (8 points for thermostat compatible), PDRYCB320 (Universal input ¹⁾), PDRYCB400 (2 points input), PDRYCB500 (Modbus)	
External Input (1 point)	○	
Wi-Fi	PWFMD200	

※ ○ : Applied, - : Not Applied
 Option: Refer to model name in table
 1) Available from April 2020

FLOOR STANDING

ARNU07GCEA4 / ARNU09GCEA4
 ARNU12GCEA4 / ARNU15GCEA4
 ARNU18GCFA4 / ARNU24GCFA4



※ A : Floor Standing with case

Model	Unit	ARNU07GCEA4	ARNU09GCEA4	ARNU12GCEA4	ARNU15GCEA4	ARNU18GCFA4	ARNU24GCFA4
Cooling Capacity	kW	2.2	2.8	3.6	4.5	5.6	7.1
Heating Capacity	kW	2.5	3.2	4.0	5.0	6.3	8.0
Power Input (H / M / L)	Nominal W	24 / 17 / 14	30 / 24 / 17	36 / 30 / 24	44 / 35 / 28	54 / 41 / 29	84 / 54 / 41
Exterior Color		Morning Fog	Morning Fog	Morning Fog	Morning Fog	Morning Fog	Morning Fog
RAL Code		RAL 9001	RAL 9001	RAL 9001	RAL 9001	RAL 9001	RAL 9001
Dimensions (W x H x D)	Body mm	1,067 x 635 x 203	1,067 x 635 x 203	1,067 x 635 x 203	1,067 x 635 x 203	1,345 x 635 x 203	1,345 x 635 x 203
	Shipping mm	1,154 x 705 x 289	1,154 x 705 x 289	1,154 x 705 x 289	1,154 x 705 x 289	1,432 x 705 x 289	1,432 x 705 x 289
	Type	Sirocco Fan	Sirocco Fan	Sirocco Fan	Sirocco Fan	Sirocco Fan	Sirocco Fan
Fan	Motor Output x Number	W x No. 19 x 1, 5 x 1	19 x 1, 5 x 1	19 x 1, 5 x 1	19 x 1, 5 x 1	19 x 2	19 x 2
	Air Flow Rate (H / M / L)	m³/min 8.5 / 7.5 / 6.5	9.5 / 8.5 / 7.5	10.5 / 9.5 / 8.5	11.5 / 10.0 / 9.5	16.0 / 14.0 / 12.0	18.0 / 16.0 / 14.0
	Motor Type	BLDC	BLDC	BLDC	BLDC	BLDC	BLDC
Air Filter		Pre Filter	Pre Filter	Pre Filter	Pre Filter	Pre Filter	Pre Filter
Pipe Connections	Liquid Side mm (inch)	Ø6.35 (1/4)	Ø6.35 (1/4)	Ø6.35 (1/4)	Ø6.35 (1/4)	Ø6.35 (1/4)	Ø9.52 (3/8)
	Gas Side mm (inch)	Ø12.7 (1/2)	Ø12.7 (1/2)	Ø12.7 (1/2)	Ø12.7 (1/2)	Ø12.7 (1/2)	Ø15.88 (5/8)
	Drain Pipe (Internal Dia.) mm (inch)	Ø12 (15/32)	Ø12 (15/32)	Ø12 (15/32)	Ø12 (15/32)	Ø12 (15/32)	Ø12 (15/32)
Weight	Body kg	27.0	27.0	27.0	27.0	34.0	34.0
Sound Pressure Levels (H / M / L)	dB(A)	35 / 33 / 31	36 / 34 / 32	37 / 35 / 33	38 / 37 / 35	40 / 37 / 34	43 / 40 / 37
Sound Power Levels (H / M / L)	dB(A)	52 / 47 / 43	54 / 51 / 47	54 / 51 / 50	55 / 54 / 51	57 / 54 / 50	61 / 57 / 54
Power Supply	Ø, V, Hz	1, 220-240, 50	1, 220-240, 50	1, 220-240, 50	1, 220-240, 50	1, 220-240, 50	1, 220-240, 50
Communication Cable	mm² x No.	1.0 - 1.5 x 2C	1.0 - 1.5 x 2C	1.0 - 1.5 x 2C	1.0 - 1.5 x 2C	1.0 - 1.5 x 2C	1.0 - 1.5 x 2C

Note : 1. Performance tested under EN14511
 2. Capacities are based on the following conditions
 - Cooling : Indoor temp. 27°C (80.6°F) DB / 19°C (66.2°F) WB, Outdoor temp. 35°C (95°F) DB / 24°C (75.2°F) WB, Interconnecting piping length 7.5m, Level difference of zero
 - Heating : Indoor temp. 20°C (68°F) DB / 15°C (59°F) WB, Outdoor temp. 7°C (44.6°F) DB / 6°C (42.8°F) WB, Interconnecting piping length 7.5m, Level difference of zero
 3. Due to our policy of innovation, some specifications may be changed without notification

Accessories

Chassis	ARNU07GCEA4	ARNU09GCEA4	ARNU12GCEA4	ARNU15GCEA4	ARNU18GCFA4	ARNU24GCFA4
Drain Pump	-	-	-	-	-	-
Cassette Cover	-	-	-	-	-	-
Refrigerant Leakage Detector	-	PRLDNVSO	-	-	PRLDNVSO	-
EEV Kit	-	PRGK024A0	-	-	-	-
Independent Power Module	-	PRIPO	-	-	PRIPO	-
Robot Cleaner	-	-	-	-	-	-
Pre Filter (Washable)	-	○	-	-	○	-
Ion Generator	-	-	-	-	-	-
CO ₂ Sensor	-	-	-	-	-	-
Ventilation Kit	-	-	-	-	-	-
IR Receiver	-	PWLRVN000	-	-	PWLRVN000	-
Zone Controller	-	-	-	-	-	-
Dry Contact (with additional accessory)	-	PDRYCB000 (1 point contact), PDRYCB300 (8 points for thermostat compatible), PDRYCB320 (Universal input ¹⁾), PDRYCB400 (2 points input), PDRYCB500 (Modbus)				-
External Input (1 point)	-	○	-	-	○	-
Wi-Fi	-	PWFMDD200	-	-	PWFMDD200	-

※ ○ : Applied, - : Not Applied
 Option: Refer to model name in table
 1) Available from April 2020

FLOOR STANDING

ARNU07GCEU4 / ARNU09GCEU4
 ARNU12GCEU4 / ARNU15GCEU4
 ARNU18GCFU4 / ARNU24GCFU4



※ U : Floor Standing without case

Model	Unit	ARNU07GCEU4	ARNU09GCEU4	ARNU12GCEU4	ARNU15GCEU4	ARNU18GCFU4	ARNU24GCFU4
Cooling Capacity	kW	2.2	2.8	3.6	4.5	5.6	7.1
Heating Capacity	kW	2.5	3.2	4.0	5.0	6.3	8.0
Power Input (H / M / L)	Nominal W	24 / 17 / 14	30 / 24 / 17	36 / 30 / 24	44 / 35 / 28	54 / 41 / 29	84 / 54 / 41
Dimensions (W x H x D)	Body mm	978 x 639 x 190	978 x 639 x 190	978 x 639 x 190	978 x 639 x 190	1,256 x 639 x 190	1,256 x 639 x 190
	Shipping mm	1,055 x 702 x 260	1,055 x 702 x 260	1,055 x 702 x 260	1,055 x 702 x 260	1,333 x 702 x 260	1,333 x 702 x 260
	Type	Sirocco Fan	Sirocco Fan	Sirocco Fan	Sirocco Fan	Sirocco Fan	Sirocco Fan
Fan	Motor Output x Number	W x No. 19 x 1, 5 x 1	19 x 1, 5 x 1	19 x 1, 5 x 1	19 x 1, 5 x 1	19 x 2	19 x 2
	Air Flow Rate (H / M / L)	m³/min 8.5 / 7.5 / 6.5	9.5 / 8.5 / 7.5	10.5 / 9.5 / 8.5	11.5 / 10.0 / 9.5	16.0 / 14.0 / 12.0	18.0 / 16.0 / 14.0
	Motor Type	BLDC	BLDC	BLDC	BLDC	BLDC	BLDC
Air Filter		Pre Filter	Pre Filter	Pre Filter	Pre Filter	Pre Filter	Pre Filter
Pipe Connections	Liquid Side mm (inch)	Ø6.35 (1/4)	Ø6.35 (1/4)	Ø6.35 (1/4)	Ø6.35 (1/4)	Ø6.35 (1/4)	Ø9.52 (3/8)
	Gas Side mm (inch)	Ø12.7 (1/2)	Ø12.7 (1/2)	Ø12.7 (1/2)	Ø12.7 (1/2)	Ø12.7 (1/2)	Ø15.88 (5/8)
	Drain Pipe (Internal Dia.) mm (inch)	Ø12 (15/32)	Ø12 (15/32)	Ø12 (15/32)	Ø12 (15/32)	Ø12 (15/32)	Ø12 (15/32)
Weight	Body kg	20.0	20.0	20.0	20.0	26.0	26.0
Sound Pressure Levels (H / M / L)	dB(A)	35 / 33 / 31	36 / 34 / 32	37 / 35 / 33	38 / 37 / 35	40 / 37 / 34	43 / 40 / 37
Sound Power Levels (H / M / L)	dB(A)	52 / 47 / 43	54 / 51 / 47	54 / 51 / 50	55 / 54 / 51	57 / 54 / 50	61 / 57 / 54
Power Supply	Ø, V, Hz	1, 220-240, 50	1, 220-240, 50	1, 220-240, 50	1, 220-240, 50	1, 220-240, 50	1, 220-240, 50
Communication Cable	mm² x No.	1.0 - 1.5 x 2C	1.0 - 1.5 x 2C	1.0 - 1.5 x 2C	1.0 - 1.5 x 2C	1.0 - 1.5 x 2C	1.0 - 1.5 x 2C

Note: 1. Performance tested under EN14511
 2. Capacities are based on the following conditions
 - Cooling : Indoor temp. 27°C (80.6°F) DB / 19°C (66.2°F) WB, Outdoor temp. 35°C (95°F) DB / 24°C (75.2°F) WB, Interconnecting piping length 7.5m, Level difference of zero
 - Heating : Indoor temp. 20°C (68°F) DB / 15°C (59°F) WB, Outdoor temp. 7°C (44.6°F) DB / 6°C (42.8°F) WB, Interconnecting piping length 7.5m, Level difference of zero
 3. Due to our policy of innovation, some specifications may be changed without notification

Accessories

Chassis	ARNU07GCEU4	ARNU09GCEU4	ARNU12GCEU4	ARNU15GCEU4	ARNU18GCFU4	ARNU24GCFU4
Drain Pump	-	-	-	-	-	-
Cassette Cover	-	-	-	-	-	-
Refrigerant Leakage Detector	-	PRLDNVSO	-	-	PRLDNVSO	-
EEV Kit	-	PRGK024A0	-	-	-	-
Independent Power Module	-	PRIPO	-	-	PRIPO	-
Robot Cleaner	-	-	-	-	-	-
Pre Filter (Washable)	-	○	-	-	○	-
Ion Generator	-	-	-	-	-	-
CO ₂ Sensor	-	-	-	-	-	-
Ventilation Kit	-	-	-	-	-	-
IR Receiver	-	PWLRVN000	-	-	PWLRVN000	-
Zone Controller	-	-	-	-	-	-
Dry Contact (with additional accessory)	-	PDRYCB000 (1 point contact), PDRYCB300 (8 points for thermostat compatible), PDRYCB320 (Universal input ¹⁾), PDRYCB400 (2 points input), PDRYCB500 (Modbus)				-
External Input (1 point)	-	○	-	-	○	-
Wi-Fi	-	PWFMDD200	-	-	PWFMDD200	-

※ ○ : Applied, - : Not Applied
 Option: Refer to model name in table
 1) Available from April 2020

COMPATIBILITY

No.	New Function Name (4 th generation indoor)	Function Description	Required Controller		Remarks
			Wired Remote Controller	Centralized Controller	
1	Energy Monitoring (Accumulated Electric Energy Check)	Monitoring accumulated power consumption by Wired Remote Controller	○	○	* Necessary to install the PDI (Power Distribution Indicator) and central controller * Combined with MULTI V WATER S outdoor unit, this function is not available.
		Monitoring accumulated power consumption by Central Control Device / PDI	-	○	* Necessary to install the PDI (Power Distribution Indicator) * To make a report, central controller must be installed
2	2 Set Point	1) 2 set point control by indoor and central controller 2) Synchronization function with remote control (Synchronization Setting and Monitoring)	○	○	* Wired remote controller and central controller must be installed. * Combined with MULTI V WATER S outdoor unit, this function is not available.
3	Occupied / Unoccupied Scheduling Function (Sub Func. Enable)	1) Synchronization according to occupied / unoccupied by indoor and Central control 2) Synchronization icon with remote controller (Synchronization Monitoring)	○	○	* Centralized control is able to when you combine only 4 th generation indoor units (Use together with 2 nd generation and 4 th generation indoors, only wired remote controller is able to set this function as existing way) * Wired remote controller or central controller must be installed (Function can be activated using just one control device.) * Combined with MULTI V WATER S outdoor unit, this function is not available.
4	Group Control	Group Control can use Additional function	○	○	* Check more details in PDB (Product Data Book) * Central controller can create and control group.
5	Test Run (Heating)	Test run mode can be operated in cooling mode and heating mode for easy service	○	-	
6	Model Information Monitoring	Product Type / Indoor Type / Indoor capacity information can be monitored by remote controller	○	-	
7	Indoor unit address checking	Wired remote controller can check indoor unit address information	○	-	
8	Refrigerant Leakage Detection	Function error sign display when refrigerant leakage occurred	○	○	* Central controller has been installed, CH230 error code can be recognized (Old / New Same) * Without Central Controller, it is able to recognize with wired remote controller (CH230) * Combined with MULTI V WATER S outdoor unit, this function is not available. * Accessory PRLDNVS0 must be separately ordered
9	Thermo On / Off range Setting (Cooling)	User can set cooling thermo on/off range with wired remote controller for prevention overcooling	○	-	* Thermo On / Off temperature setting (3 step)
10	Thermo On / Off range Setting (Heating)	User can set heating thermo on/off range with wired remote controller for prevention overheating. (4 Step)	○	-	* Thermo On / Off temperature setting (4 step)
11	Static Pressure 11 Step Control (Only for Ceiling Concealed Duct Type)	Depends on the installation environment, 4 th generation Ceiling Concealed Duct can control the static pressure by 11 steps for providing comfortable environment	○	-	* Only applied in Ceiling Concealed Duct
12	1 point External Input (On / Off control)	Indoor unit can be controlled by external devices without purchasing Dry contact as an accessory (All 4 th generation indoors)	○	-	* Simple On/Off control by Dry Contact at Indoor [Example of Contact port by product type] * 2 Way Cassette : CN-CC Port (Wired remote controller installation function mode 41 is required) * 1 Way / 4 Way Cassette / Ceiling Concealed Duct / Wall Mounted Unit Console / FAU / Floor Standing (with case / without case) : CN-EXT Port
13	Filter Sign (Remaining Time)	The alarm activates when the filter needs to be cleaned, and the time remaining for cleaning is displayed on the screen.	○	○	* The alarm activates on the central controller, but the remaining time is not displayed.
14	Auto restart function Disable / Enable	After the power failure compensation, stand by at OFF mode Restore the operation for the status before the power off	○	-	
15	Indoor Humidity display	Monitoring indoor humidity Wired Remote Controller	○	○	* Available only with MULTI V 5
16	Comfort Cooling setting	set the outdoor unit comfort cooling operation value	○	○	* Available only with MULTI V 5
17	Smart Load Control setting	Change the outdoor unit's Smart Load Control stage value.	○	○	* Available only with MULTI V 5
18	ODU Refrigerant Noise Reduction setting	set the outdoor unit's refrigerant noise reduction function	○	○	* Available only with MULTI V 5
19	Low noise mode time setting	set the start and end time of the outdoor unit's low noise mode operation	○	○	* Available only with MULTI V 5

Note : 1) No.1, 2, 3, 8 : Functions are available to use together with 4th generation Indoor units only. If used together 2nd generation indoor unit and 4th generation indoor unit functions will not be activate. Combined with MULTI V Water S outdoor unit this function is not available
2) No. 4, 5, 6, 7, 9, 10, 11, 12, 13, 14 : If used together 2nd generation indoor unit and 4th generation indoor unit these functions will be activate only in 4th generation indoor
3) 2nd generation indoor unit : Ceiling & Floor Convertible Unit, Ceiling Suspended Unit, HYDRO KIT (Low Temp. / High Temp.), ERV DX (with Humidifier, without Humidifier), AHU Communication Kit

Wired Remote Controller					Centralized Controller				
Premium (PREMTA000 PREMTA000A PREMTA000B)	Standard III (PREMTB100) (PREMTB10)	Standard II (PREMTB01) (PREMTB001)	Simple		AC EZ (PQCSZ250S0)	AC EZ Touch (PACEZA000)	AC Smart 5 (PACSSA000)	ACP 5 (PACP5A000)	AC Manager 5 (PACM5A000)
			Simple for Hotel (PQRCHCA0Q / QW)	Simple (PQRCVCL0Q / QW)					
○	○	○	-	-	-	○	○	○	○
-	-	-	-	-	-	○	○	○	○
○	○	-	-	-	-	○	○	○	○
○	○	-	-	-	-	○	○	○	○
○	○	○	-	-	-	-	○	○	○
○	○	○	-	-	-	-	-	-	-
○	○	○	-	-	-	-	○	○	-
○	○	○	-	-	-	-	-	-	-
○	○	○	-	-	-	-	-	-	-
○ (4 step)	○ (4 step)	○ (3 step)	○ (3 step)	○ (3 step)	-	-	-	-	-
○	○	○	○	○	-	-	-	-	-
-	○	○	-	-	-	-	-	-	-
○	○	○	-	-	○	○	○	○	○
○	○	○	-	-	-	-	-	-	-
-	○	-	-	-	-	-	○	○	-
-	○	-	-	-	-	-	○	○	-
-	○	-	-	-	-	-	○	○	-
-	○	-	-	-	-	○	○	○	-

※ ○ : Applied, - : Not applied

COMPATIBILITY

Controller		Premium	Standard III	Standard II	Simple	Simple for Hotel	Wireless	Dry Contact						
		PREMTA000 PREMTA000A PREMTA000B	PREMTB100	PREMTB100	PREMTB001	PREMTB001	PQRCVCLQ	PQRCVCOQW	PQRCHCA0Q	PQRCHCA0QW	NEW PWLSSB21H (H/P)	Simple Dry Contact PDRYCB000	2 points Dry Contact PDRYCB400	Dry Contact for Thermostat PDRYCB300 NEW PDRYCB320*
Ceiling Mounted Cassette	4 Way	○	○	○	○	○	○	○	○	○	○	○	○	○
	2 Way / 1 Way	○	○	○	○	○	○	○	○	○	○	○	○	○
Ceiling Concealed Duct	Round CST	○	○	○	○	○	○	○	○	○	○	○	○	○
	High Sensible	○	○	○	○	○	△	○	○	○	○	○	○	○
	High / Mid Statics	○	○	○	○	○	△	○	○	○	○	○	○	○
FAU (Fresh Air intake)	Low Statics	○	○	○	○	○	△	○	○	○	○	○	○	○
	ARNU-Z4	○	○	○	○	○	△	○	○	○	○	○	○	○
Convertible & Ceiling Suspended	ARNU-A4	○	○	○	○	○	○	○	○	○	○	○	○	○
	ARNU-U4	○	○	○	○	○	○	○	○	○	○	○	○	○
MULTI V Console	ARNU-A4	○	○	○	○	○	○	○	○	○	○	○	○	○
	ARNU-U4	○	○	○	○	○	○	○	○	○	○	○	○	○
Floor Standing	ARNU-A4	○	○	○	○	○	○	○	○	○	○	○	○	○
	ARNU-U4	○	○	○	○	○	○	○	○	○	○	○	○	○
Wall Mounted	ARNU-A4	○	○	○	○	○	○	○	○	○	○	○	○	○
	ARNU-C4 ARNU-N4	○	○	○	○	○	○	○	○	○	○	○	○	○
HYDRO KIT 1)	ARNH-A4	-	-	-	-	-	-	○	-	○	-	-	-	-
	Energy Recovery Ventilator	○	○	○	-	-	-	○	-	-	-	-	○	-
Ventilation	Energy Recovery Ventilator with DX coil	○	○	○	-	-	-	○	-	-	-	-	○	-
	AHU Communication Kit	○	○	○	-	-	△	-	-	-	-	-	-	-

※ ○ : Compatible, △ : Need wired remote controller / IR receiver, - : Not compatible
 * Available from April 2020
 1) It has a separate remote controller

FEATURE FUNCTIONS

Controller Name	Wired Remote Controller					Wireless Remote Controller	Wi-fi Controller																																																																																																																								
	Premium	Standard III	Standard II	Simple	Simple(Hotel)																																																																																																																										
Model Name	PREMTA000 PREMTA000A PREMTA000B	PREMTB100 PREMTB110	PREMTB001 PREMTB001	PQRCVCLQ PQRCVCLQW	PQRCHCA0Q PQRCHCA0QW	NEW PWLSSB21H (H/P)	PWFMD200																																																																																																																								
Basic	<table border="1"> <tr><td>On / Off</td><td>○</td><td>○</td><td>○</td><td>○</td><td>○</td><td>○</td><td>○</td></tr> <tr><td>Fan Speed Control</td><td>○</td><td>○</td><td>○</td><td>○</td><td>○</td><td>○</td><td>○</td></tr> <tr><td>Temperature Setting</td><td>○</td><td>○</td><td>○</td><td>○</td><td>○</td><td>○</td><td>○</td></tr> <tr><td>Mode Change</td><td>○</td><td>○</td><td>○</td><td>○</td><td>-</td><td>○</td><td>○</td></tr> <tr><td>Auto Swing</td><td>○</td><td>○</td><td>○</td><td>○</td><td>○</td><td>○</td><td>○</td></tr> <tr><td>Vane Control (Louver Angle)</td><td>○</td><td>○</td><td>○</td><td>○</td><td>○</td><td>○</td><td>○</td></tr> <tr><td>E.S.P (External Static Pressure)</td><td>○</td><td>○</td><td>○</td><td>○</td><td>○</td><td>-</td><td>-</td></tr> <tr><td>Electric Failure Compensation</td><td>○</td><td>○</td><td>○</td><td>○</td><td>○</td><td>-</td><td>○</td></tr> <tr><td>Indoor Temperature Display</td><td>○</td><td>○</td><td>○</td><td>○</td><td>○</td><td>○</td><td>○</td></tr> <tr><td>ALL Button Lock (Child Lock)</td><td>○</td><td>○</td><td>○</td><td>○</td><td>○</td><td>-</td><td>-</td></tr> <tr><td>Schedule / Timer</td><td>Weekly - Yearly</td><td>Weekly - Yearly</td><td>Weekly</td><td>-</td><td>-</td><td>Sleep / On / Off</td><td>Weekly</td></tr> <tr><td>Additional Mode Setting 1)</td><td>○</td><td>○</td><td>○</td><td>-</td><td>-</td><td>-</td><td>-</td></tr> <tr><td>Time Display</td><td>○</td><td>○</td><td>○</td><td>-</td><td>-</td><td>○</td><td>-</td></tr> <tr><td>Humid. Display</td><td>○</td><td>○</td><td>-</td><td>-</td><td>-</td><td>-</td><td>-</td></tr> <tr><td>Advanced Lock (mode, set point, set point range, on/off Lock)</td><td>Advanced Lock</td><td>Advanced Lock</td><td>-</td><td>-</td><td>-</td><td>-</td><td>-</td></tr> </table>							On / Off	○	○	○	○	○	○	○	Fan Speed Control	○	○	○	○	○	○	○	Temperature Setting	○	○	○	○	○	○	○	Mode Change	○	○	○	○	-	○	○	Auto Swing	○	○	○	○	○	○	○	Vane Control (Louver Angle)	○	○	○	○	○	○	○	E.S.P (External Static Pressure)	○	○	○	○	○	-	-	Electric Failure Compensation	○	○	○	○	○	-	○	Indoor Temperature Display	○	○	○	○	○	○	○	ALL Button Lock (Child Lock)	○	○	○	○	○	-	-	Schedule / Timer	Weekly - Yearly	Weekly - Yearly	Weekly	-	-	Sleep / On / Off	Weekly	Additional Mode Setting 1)	○	○	○	-	-	-	-	Time Display	○	○	○	-	-	○	-	Humid. Display	○	○	-	-	-	-	-	Advanced Lock (mode, set point, set point range, on/off Lock)	Advanced Lock	Advanced Lock	-	-	-	-	-
On / Off	○	○	○	○	○	○	○																																																																																																																								
Fan Speed Control	○	○	○	○	○	○	○																																																																																																																								
Temperature Setting	○	○	○	○	○	○	○																																																																																																																								
Mode Change	○	○	○	○	-	○	○																																																																																																																								
Auto Swing	○	○	○	○	○	○	○																																																																																																																								
Vane Control (Louver Angle)	○	○	○	○	○	○	○																																																																																																																								
E.S.P (External Static Pressure)	○	○	○	○	○	-	-																																																																																																																								
Electric Failure Compensation	○	○	○	○	○	-	○																																																																																																																								
Indoor Temperature Display	○	○	○	○	○	○	○																																																																																																																								
ALL Button Lock (Child Lock)	○	○	○	○	○	-	-																																																																																																																								
Schedule / Timer	Weekly - Yearly	Weekly - Yearly	Weekly	-	-	Sleep / On / Off	Weekly																																																																																																																								
Additional Mode Setting 1)	○	○	○	-	-	-	-																																																																																																																								
Time Display	○	○	○	-	-	○	-																																																																																																																								
Humid. Display	○	○	-	-	-	-	-																																																																																																																								
Advanced Lock (mode, set point, set point range, on/off Lock)	Advanced Lock	Advanced Lock	-	-	-	-	-																																																																																																																								
Advanced	<table border="1"> <tr><td>Filter Sign</td><td>○</td><td>○</td><td>○</td><td>-</td><td>-</td><td>-</td><td>-</td></tr> <tr><td>Energy Management 2)</td><td>○</td><td>○</td><td>○</td><td>-</td><td>-</td><td>-</td><td>-</td></tr> <tr><td>Dual Set Point</td><td>○</td><td>○</td><td>-</td><td>-</td><td>-</td><td>-</td><td>-</td></tr> <tr><td>Human Detection</td><td>-</td><td>○</td><td>-</td><td>-</td><td>-</td><td>-</td><td>-</td></tr> <tr><td>Temp, Humidity Compensation</td><td>○</td><td>○</td><td>-</td><td>-</td><td>-</td><td>-</td><td>-</td></tr> <tr><td>Wifi AP mode setting</td><td>○</td><td>○</td><td>○</td><td>○</td><td>○</td><td>○</td><td>-</td></tr> <tr><td>Operation Status LED</td><td>○</td><td>○</td><td>○</td><td>○</td><td>○</td><td>-</td><td>-</td></tr> <tr><td>Wireless Remote Controller Receiver</td><td>○³⁾</td><td>-</td><td>○³⁾</td><td>○³⁾</td><td>○³⁾</td><td>-</td><td>-</td></tr> </table>							Filter Sign	○	○	○	-	-	-	-	Energy Management 2)	○	○	○	-	-	-	-	Dual Set Point	○	○	-	-	-	-	-	Human Detection	-	○	-	-	-	-	-	Temp, Humidity Compensation	○	○	-	-	-	-	-	Wifi AP mode setting	○	○	○	○	○	○	-	Operation Status LED	○	○	○	○	○	-	-	Wireless Remote Controller Receiver	○ ³⁾	-	○ ³⁾	○ ³⁾	○ ³⁾	-	-																																																								
Filter Sign	○	○	○	-	-	-	-																																																																																																																								
Energy Management 2)	○	○	○	-	-	-	-																																																																																																																								
Dual Set Point	○	○	-	-	-	-	-																																																																																																																								
Human Detection	-	○	-	-	-	-	-																																																																																																																								
Temp, Humidity Compensation	○	○	-	-	-	-	-																																																																																																																								
Wifi AP mode setting	○	○	○	○	○	○	-																																																																																																																								
Operation Status LED	○	○	○	○	○	-	-																																																																																																																								
Wireless Remote Controller Receiver	○ ³⁾	-	○ ³⁾	○ ³⁾	○ ³⁾	-	-																																																																																																																								
ETC	<table border="1"> <tr><td>Display</td><td>5 inch Color</td><td>4.3 inch Color</td><td>4.3 inch mono</td><td>2.6 inch mono</td><td>2.6 inch mono</td><td>2 inch mono</td><td>-</td></tr> <tr><td>Size (W x H x D, mm)</td><td>137 x 121 x 16.5</td><td>120 x 120 x 16</td><td>120 x 120 x 16</td><td>64 x 120 x 15</td><td>64 x 120 x 15</td><td>51 x 153 x 26</td><td>-</td></tr> <tr><td>Black Light Control for Screen Saver</td><td>○</td><td>○</td><td>-</td><td>-</td><td>-</td><td>-</td><td>-</td></tr> </table>							Display	5 inch Color	4.3 inch Color	4.3 inch mono	2.6 inch mono	2.6 inch mono	2 inch mono	-	Size (W x H x D, mm)	137 x 121 x 16.5	120 x 120 x 16	120 x 120 x 16	64 x 120 x 15	64 x 120 x 15	51 x 153 x 26	-	Black Light Control for Screen Saver	○	○	-	-	-	-	-																																																																																																
Display	5 inch Color	4.3 inch Color	4.3 inch mono	2.6 inch mono	2.6 inch mono	2 inch mono	-																																																																																																																								
Size (W x H x D, mm)	137 x 121 x 16.5	120 x 120 x 16	120 x 120 x 16	64 x 120 x 15	64 x 120 x 15	51 x 153 x 26	-																																																																																																																								
Black Light Control for Screen Saver	○	○	-	-	-	-	-																																																																																																																								

※ ○ : Applied, - : Not Applied
 1) It might not be indicated or operated at the partial product
 2) Centralized control (PACEZA000 / PACSSA000 / PACPSA000 / PLNWK000) and PDI (PQNUD1S40 / PPWRDB000) should be installed for this function
 3) For ceiling type duct
 Note
 - Indoor unit should have functions requested by the controller
 - If you need more detail, please refer to the manual of product. (<http://partner.lge.com: Home > DocLibrary > Manual>)

HOT WATER SOLUTION

—
HYDRO KIT



HYDRO KIT

Features & Benefits

- Lower operation cost compared to fossil fuel-based systems such as boilers.
- More energy saving through MULTI V heat recovery system.

Key Applications

- Where Hot Water is needed such as domestic Hot Water, In-floor or radiant heat. Where cold water is needed such as Fan coil unit and chilled beam.

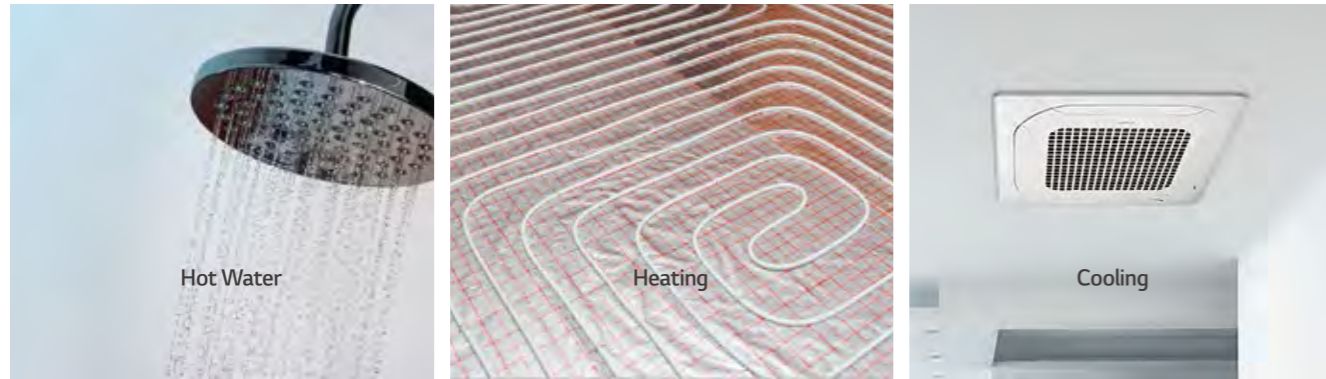

Radiant Heating / Cooling

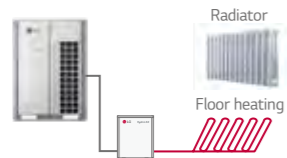

Fan Coil Unit Heating / Cooling

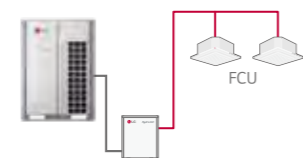

Hot Water / Cold Water

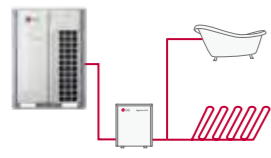
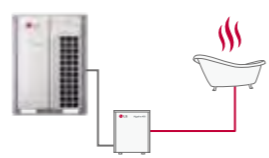

Hot water+ Radiant heating

Combination

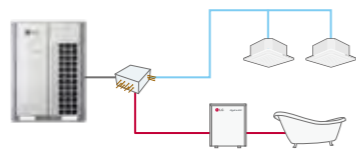

HR unit (Cooling & Hot water)

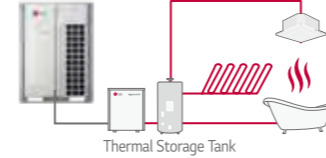

Thermal Storage System

CONVENIENCE

Total Solution

Total solution provided with heat pump, air conditioning (Cooling by refrigerant and cold water / heating by refrigerant hot water) and domestic hot water supply.

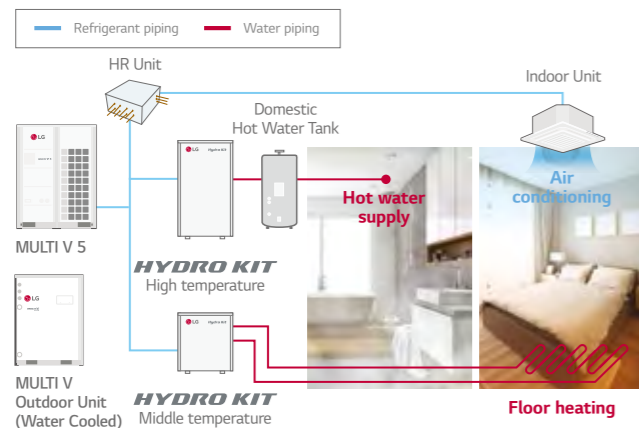

Eco-friendly Solution

Green energy solution through the reduction of CO₂ emissions.

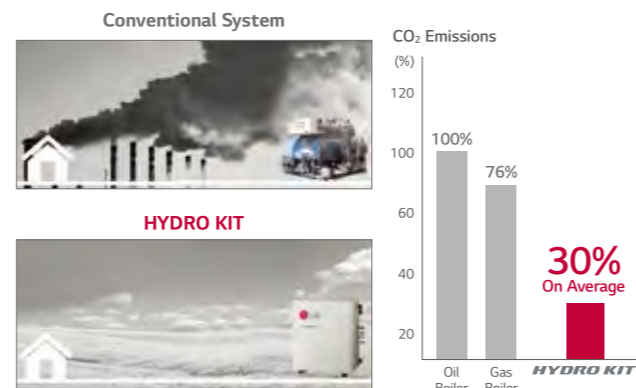

EFFICIENCY

Cost Savings with High Efficiency

Equivalent installation cost of traditional boiler with reduced operational costs.

- 1st Proposal MULTI V 5 HYDRO KIT (Air Conditioning + Hot Water Supply + Floor Heating)
- 2nd Proposal MULTI V 5 Air-Conditioning + Gas Boiler (Hot Water Supply + Floor Heating)
- 3rd Proposal MULTI V 5 Air-Conditioning + Oil Boiler (Hot Water Supply + Floor Heating)

Analysis Conditions

- Building Type : Dormitory, Flats
- Cooling / Floor Heating / Sanitary Hot Water for 10 years
- Cooling : MULTI V IV Indoor Unit
- Floor Heating : Medium Temp. HYDRO KIT (1ea)
- Sanitary Hot Water : High Temp. HYDRO KIT (2ea), Sanitary Hot Water Tanks
- Electricity Cost : Average Cost in EU
- Gas Cost : Average Cost in EU
- Oil Cost : Average Cost in EU

Initial Costs

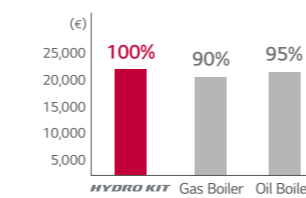

Annual Operating Costs

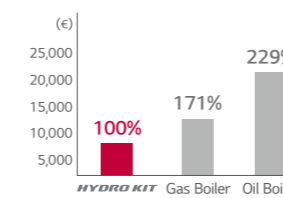

LCC

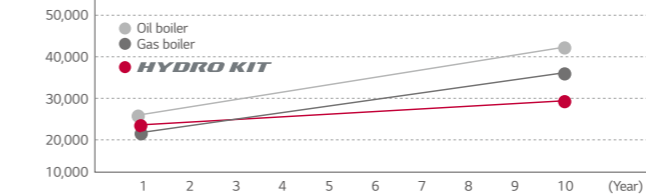

Energy Savings through Heat Recovery

Energy costs can be minimized by reusing the wasted heat from indoor units.

Conventional

Absorbed heat is released to outdoor air.

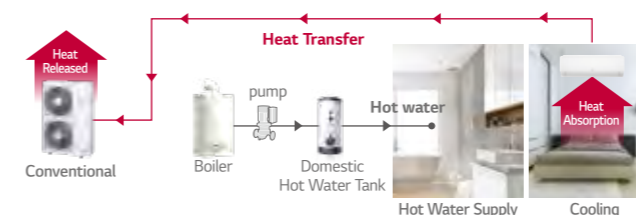

HYDRO KIT

Absorbed heat from indoor space is used for making hot water.

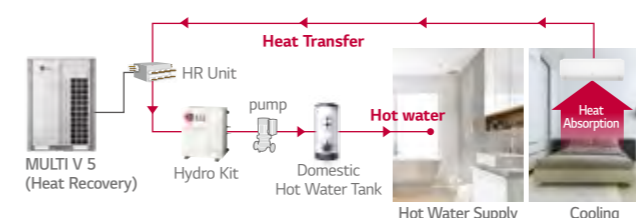

High Temperature HYDRO KIT Cycle Diagram

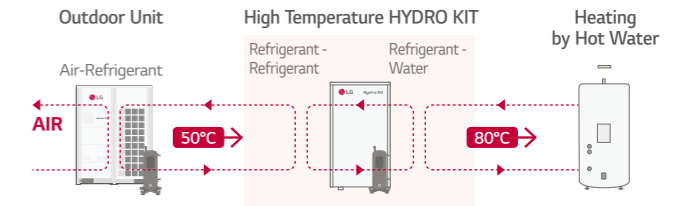

High Temperature Technology

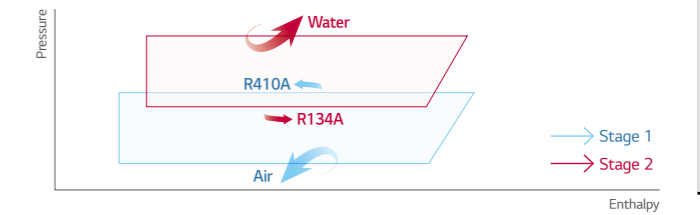

Various Applications

Applicable to a variety of facilities including hospitals, residences and resorts that need floor heating and domestic hot water supply.

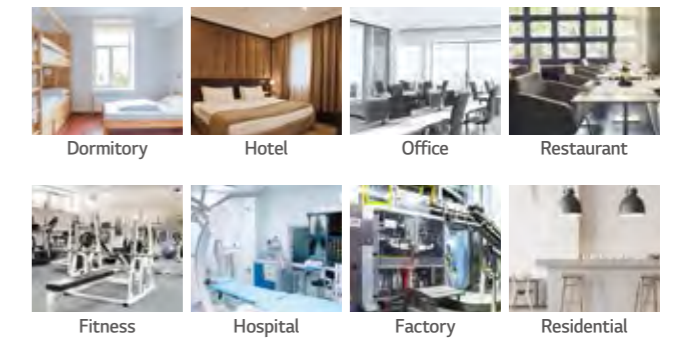

Hotel Application

Constant simultaneous cooling and heating operation during summer to provide hot water by using wasted heat energy from indoor cooling process.

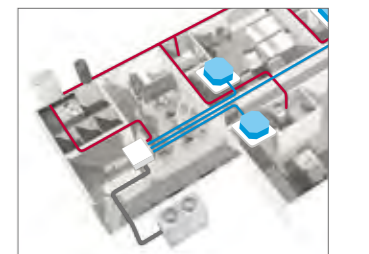

Office Application

Hot water can be supplied at all times in the office by cooling the HR unit to warm up the sanitary tank, using waste energy.

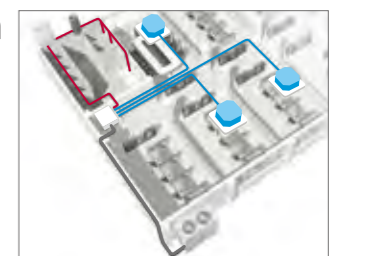

HYDRO KIT

ARNH04GK2A4 / ARNH10GK2A4



Model	Unit	ARNH04GK2A4	ARNH10GK2A4
Cooling Capacity	kW	12.3	28.0
Heating Capacity	kW	13.8	31.5
Power Input Nominal ¹⁾	W	10	10
Exterior Color		Morning Gray	Morning Gray
RAL Code		RAL 7030	RAL 7030
Dimensions (W x H x D)	Body	520 x 631 x 330	520 x 631 x 330
	Shipping	677 x 687 x 418	677 x 687 x 418
Pipe Connections	Liquid Side	Ø9.52 (3/8)	Ø9.52 (3/8)
	Gas Side	Ø15.88 (5/8)	Ø22.2 (7/8)
	Drain Pipe (Internal Dia.)	A (inch)	25A (Male PT 1)
Water Pipe Connections	Inlet	A (inch)	25A (Male PT 1)
	Outlet	A (inch)	25A (Male PT 1)
Weight	kg	29.2	33.7
Sound Pressure Levels (H / M / L)	dB(A)	26	26
Power Supply	Ø, V, Hz	1, 220-240, 50	1, 220-240, 50
Communication Cable	mm ² x No.	1.0 ~ 1.5 x 2C	1.0 ~ 1.5 x 2C

1) Nominal : Performance tested under EN14511

Note : 1. Capacities are based on the following conditions :

- Cooling : Indoor 27°C (80.6°F) DB / 19°C (66.2°F) WB, Outdoor 35°C (95°F) DB / 24°C (75.2°F) WB, Water Inlet 23°C (73.4°F) / Outlet 18°C (64.4°F)
- Heating : Indoor 20°C (68°F) DB / 15°C (59°F) WB, Outdoor 7°C (44.6°F) DB / 6°C (42.8°F) WB, Water Inlet 30°C (86°F) / Outlet 35°C (95°F)

- Piping Length : Interconnected Pipe Length = 7.5m
- Difference Limit of Elevation (Outdoor - Indoor Unit) is Zero.
- MULTI V S 4HP (ARUN040GSS0, ARUN040LSS0) cannot be connected to Hydro Kit.
- MULTI V Water S cannot be connected to Hydro Kit.
- Anti freezing liquid should be added under 10°C (outdoor temp.) during cooling mode.

Accessories

Chassis	ARNH04GK2A4	ARNH10GK2A4
Drain Pump	-	-
Cassette Cover	-	-
Refrigerant Leakage Detector		PRLDNVSO
EEV Kit	-	-
Independent Power Module		○
Robot Cleaner	-	-
Pre Filter (Washable)	-	-
Ion Generator	-	-
CO ₂ Sensor	-	-
Ventilation Kit	-	-
IR Receiver	-	-
Zone Controller	-	-
Dry Contact (with additional accessory)		PDRYCB000 (1 point contact), PDRYCB300 (8 points for thermostat compatible) PDRYCB320 (Universal input ¹⁾)
External Input (1 point)		○
Wi-Fi		PWFMD200

※ ○ : Applied, - : Not applied
Option : Refer to model name in table
1) Available from April 2020

HYDRO KIT

ARNH04GK3A4 / ARNH08GK3A4



Model	Unit	ARNH04GK3A4	ARNH08GK3A4
Heating Capacity	kW	13.8	25.2
Power Input Nominal ¹⁾	W	2,300	5,000
Exterior Color		Morning Gray	Morning Gray
RAL Code		RAL 7030	RAL 7030
Dimensions (W x H x D)	Body	520 x 1,080 x 330	520 x 1,080 x 330
	Shipping	682 x 1,168 x 423	682 x 1,168 x 423
Pipe Connections	Liquid Side	Ø9.52 (3/8)	Ø9.52 (3/8)
	Gas Side	Ø15.88 (5/8)	Ø19.05 (3/4)
	Drain Pipe (Internal Dia.)	A (inch)	25A (Male PT 1)
Water Pipe Connections	Inlet	A (inch)	25A (Male PT 1)
	Outlet	A (inch)	25A (Male PT 1)
Weight	kg	87.0	91.0
Sound Pressure Levels (H / M / L)	dB(A)	43	46
Power Supply	Ø, V, Hz	1, 220-240, 50	1, 220-240, 50
Communication Cable	mm ² x No.	1.0 ~ 1.5 x 2C	1.0 ~ 1.5 x 2C

1) Nominal : Performance tested under EN14511

Note : 1. Capacities are based on the following conditions :

- Heating : Indoor 20°C (68°F) DB / 15°C (59°F) WB, Outdoor 7°C (44.6°F) DB / 6°C (42.8°F) WB, Water Inlet 55°C (131°F) / Outlet 65°C (149°F)

- Piping Length : Interconnected Pipe Length = 7.5m
- Difference Limit of Elevation (Outdoor - Indoor Unit) is Zero.
- MULTI V S 4HP (ARUN040GSS0, ARUN040LSS0) cannot be connected to Hydro Kit.
- MULTI V Water S cannot be connected to Hydro Kit.

Accessories

Chassis	ARNH04GK3A4	ARNH08GK3A4
Drain Pump	-	-
Cassette Cover	-	-
Refrigerant Leakage Detector		PRLDNVSO
EEV Kit	-	-
Independent Power Module		○
Robot Cleaner	-	-
Pre Filter (Washable)	-	-
Ion Generator	-	-
CO ₂ Sensor	-	-
Ventilation Kit	-	-
IR Receiver	-	-
Zone Controller	-	-
Dry Contact (with additional accessory)		PDRYCB000 (1 point contact), PDRYCB300 (8 points for thermostat compatible) PDRYCB320 (Universal input ¹⁾)
External Input (1 point)		○
Wi-Fi		PWFMD200

※ ○ : Applied, - : Not applied
Option : Refer to model name in table
1) Available from April 2020

VENTILATION SOLUTIONS

ERV / ERV WITH DX COIL



ENERGY RECOVERY VENTILATION (ERV)



NECESSITY OF ERV

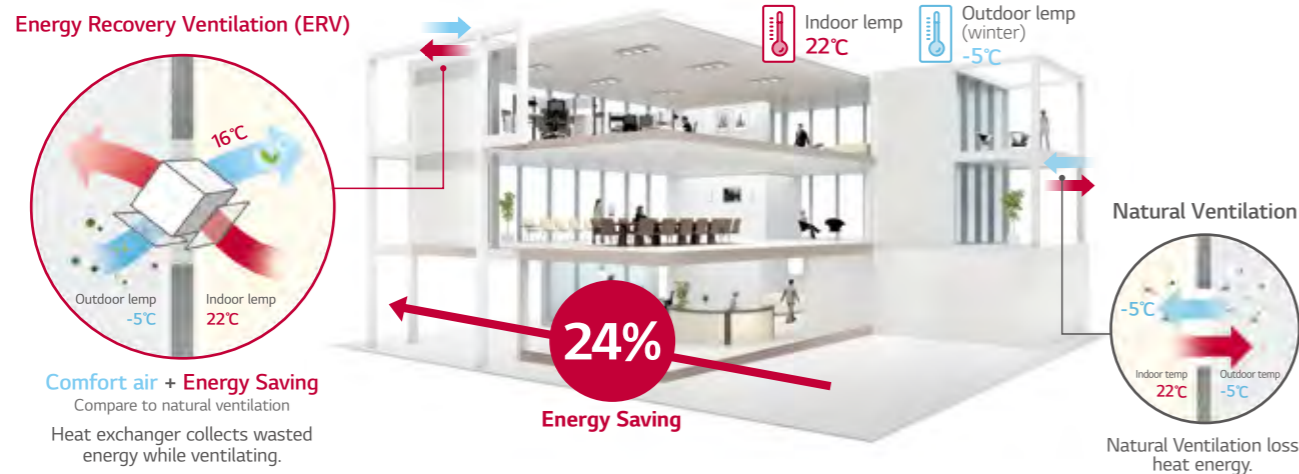

HIGH EFFICIENCY

High Efficiency Heat Exchanger

Efficiency and comfort is ensured through the high-efficiency energy recovery central core which recovers energy from the indoor air and transfers it to the fresh incoming air without mixing the air stream.

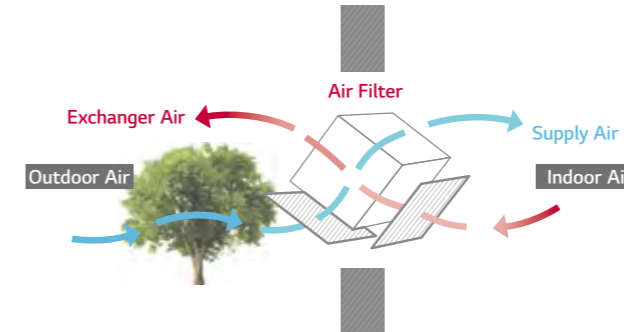

Exhaust System

The exhaust system uses a high static sirocco fan to effectively remove contaminants from indoor air. Supply and exhaust air flows are completely separated in the heat exchanger, allowing the LG ERV to filter out impurities before supplying outdoor air to ensure indoor air is fresh and healthy.

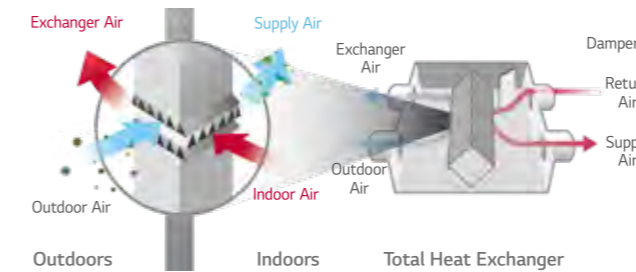

Night Time Free Cooling

During summer nights, indoor heat can be discharged outdoors and cool outdoor air can be brought indoors for energy savings.

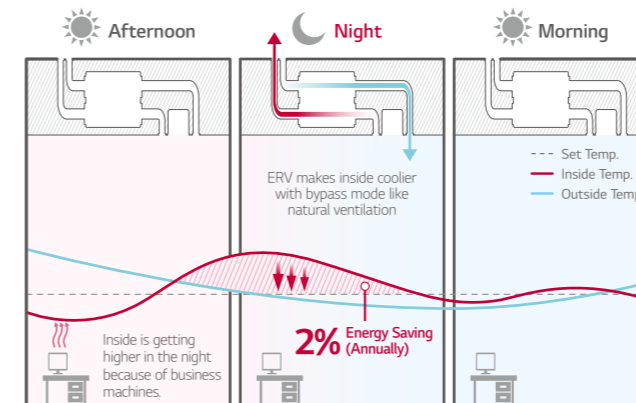

※ This function is operated with 'Night Time Free Cooling' on remote controller. (with MULTI V only)
 ※ Energy saving ratio can be differed by weather condition.
 ※ Test Condition
 - Office (49,000ft²) / Occupancy : 30 / Area : London, UK
 - ERV (1000 CMH) + MULTI V 4 (12HP) Unit Combination
 - Other conditions are subject to BREEAM.

CO₂ Auto Operation

LG ERV reduces energy loss with auto fan speed control following CO₂ level

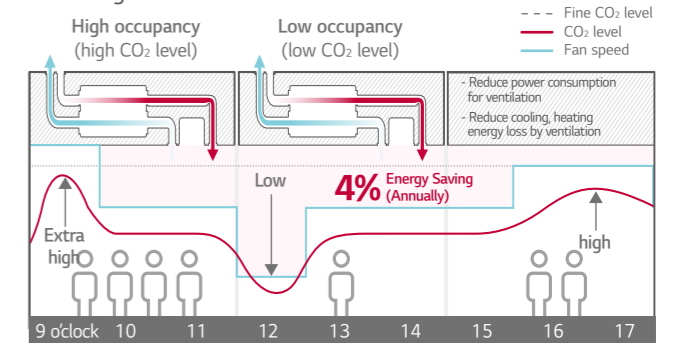

※ This function is operated with 'Night Time Free Cooling' on remote controller. (with MULTI V only)
 ※ Energy saving ratio can be differed by weather condition.
 ※ Test Condition - Office (49,000ft²) / Occupancy : 30 / Area : London, UK
 - ERV (1000 CMH) + MULTI V 4 (12HP) Unit Combination
 - Other conditions are subject to BREEAM.

Seasonal Auto Operation

LG ERV senses outdoor temperature and operates automatically following weather condition.

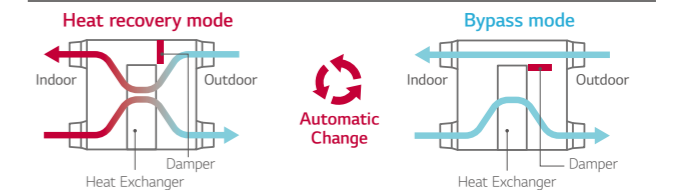
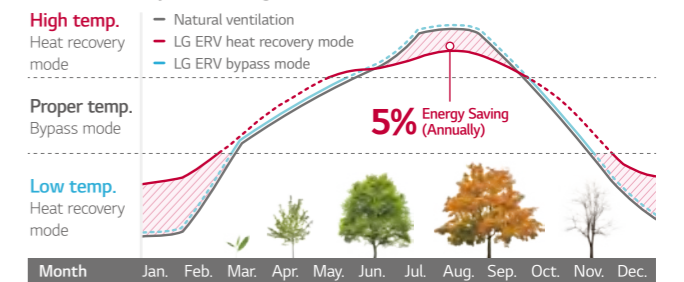

※ This function is operated with 'Auto' mode by wired remote control.
 ※ Energy saving ratio can be differed by weather condition.
 ※ Test Condition - Office (49,000ft²) / Occupancy : 30 / Area : London, UK
 - ERV (1,000 CMH) + MULTI V 4 (12HP) Unit Combination
 - Other conditions are subject to BREEAM.

Delay Operation

When the air conditioner and ERV are switched on simultaneously, delay operation can reduce unnecessary heating and cooling energy loss by slowing down automatic ERV operation.

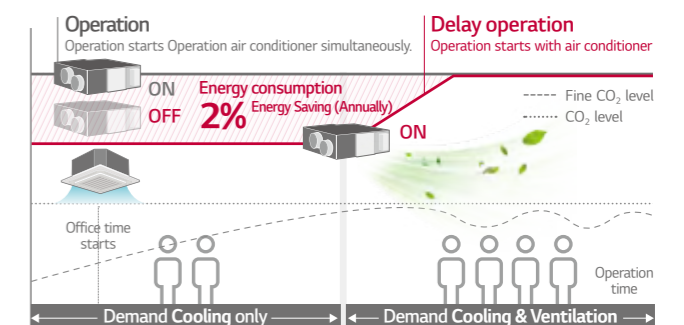

※ This function is operated with 'Night Time Free Cooling' on remote controller. (with MULTI V only)
 ※ Energy saving ratio can be differed by weather condition.
 ※ Test Condition - Office (49,000ft²) / Occupancy : 30 / Area : London, UK
 - ERV (1000 CMH) + MULTI V 4 (12HP) Unit Combination
 - Other conditions are subject to BREEAM.

COMFORT & RELIABILITY

CO₂ Level Monitoring

CO₂ sensor senses CO₂ level in the room. Users can monitor CO₂ level on new wired remote controller, and ERV controls the fan speed automatically following the level.

CO₂ Level Visualization

CO₂ sensor senses indoor CO₂ level and displays it on new wired remote controller.



Main display

If the CO₂ level is above 900ppm in the room, the red mark is on.



※ The remote controller screen image may change.
※ Applicable to only Standard III, Premium remote controller

Further information

CO₂ level and room condition are displayed continuously.

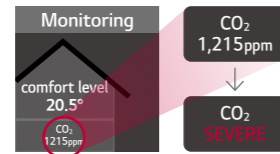

CO₂ Concentration Control

Using CO₂ sensor, LG ERV controls exhaust air flow automatically to keep indoor air fresh under settled CO₂ concentration.

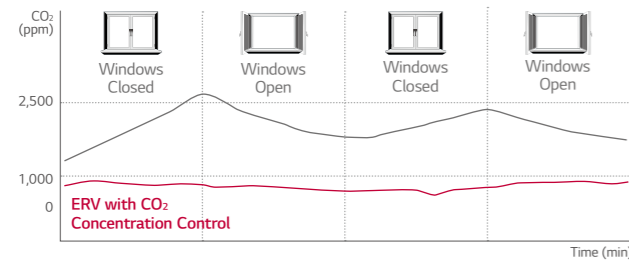
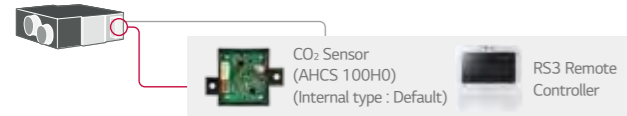

High Durability

LG ERV durability is increased through bacteria-resistant material of heat exchanger and corrosion protection coating. It prevents shortening product life due to corrosion and mold and supplies high quality air to inside by minimizing the bacteria.

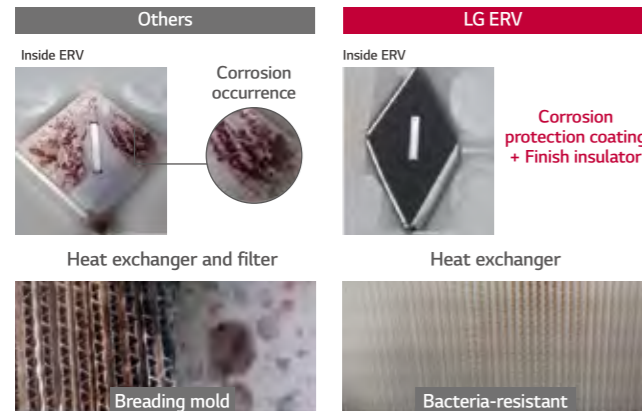

CONVENIENCE

Easy Control

Wired remote controller is easy for usage.



Easy

- Navigation buttons, easy to use.
- Easy installation setting



Convenient

- Flexible display
- Dual display with air conditioner.
- Zoom selected directory to increase legibility.



Visible

- Indoor CO₂ level
- Alarm for filter change / Remained time to change filters

Group Control

1 wired remote controller up to 16 ERV (Including air conditioner). It is convenient for large common space such as lobby.

Several units combination

16 units group control is available with 1 remote controller.

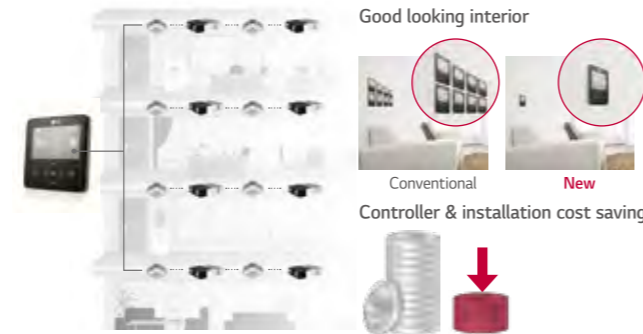

Interlocking with Air Conditioning System

- LG ERV can be interlocked with air conditioners and controlled individually.
- This function can be operated when the system is connected with 1 remote controller.

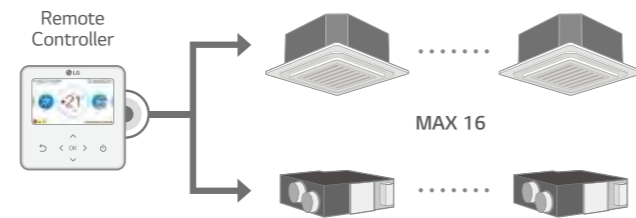

CONVENIENCE

Fast Ventilation Mode

Fast ventilation mode prevents the spread of contaminants under negative indoor pressure, and makes indoor air fresh and comfortable quickly.

Only Exhausting

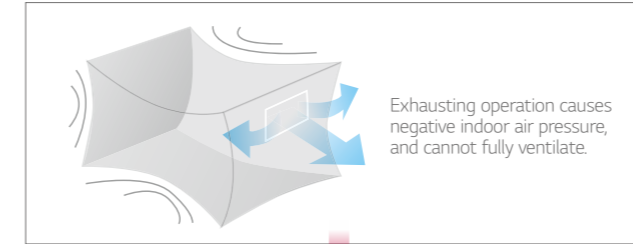

Exhausting operation causes negative indoor air pressure, and cannot fully ventilate.

Exhausting and Supplying Simultaneously

Fast Ventilation Mode

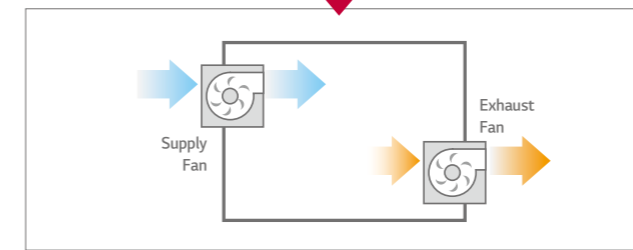

External Static Pressure Control

The high static pressure fan can control the air volume depending on the length of the duct. It is also easy to control the pressure level by using the remote controller for a more flexible duct installation and easier testing.

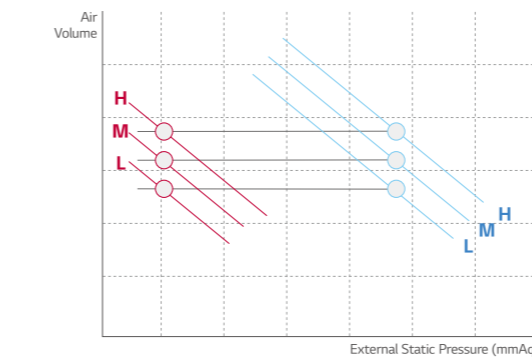

Easy Cleaning and Filter Change

Filter can be conveniently changed and cleaned.

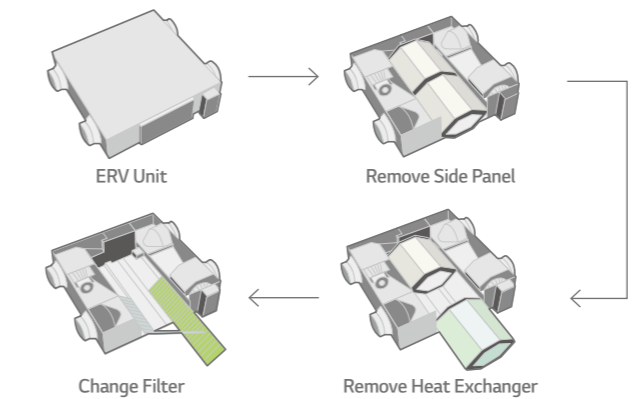

Installation Scene

LZ-H025GBA4 / LZ-H035GBA5 / LZ-050GBA5

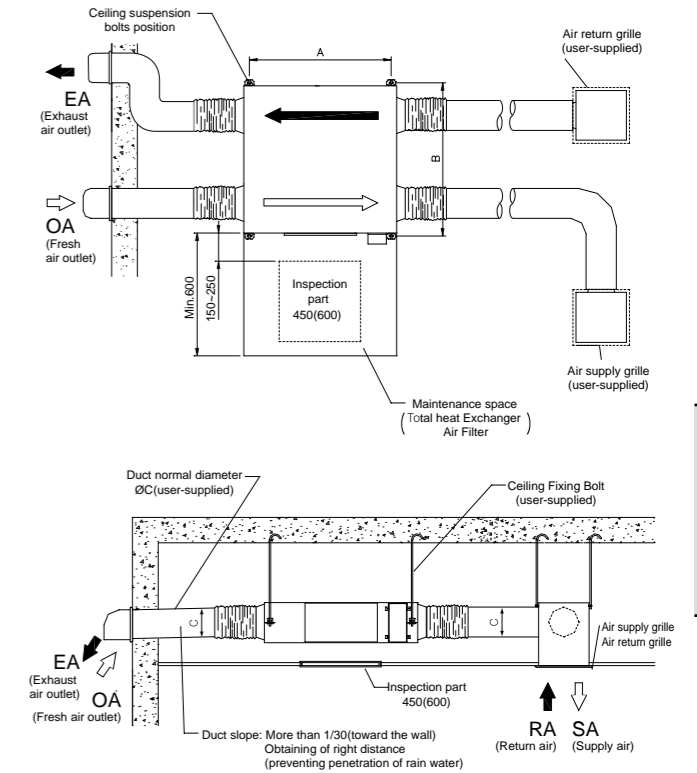

Connection of Duct

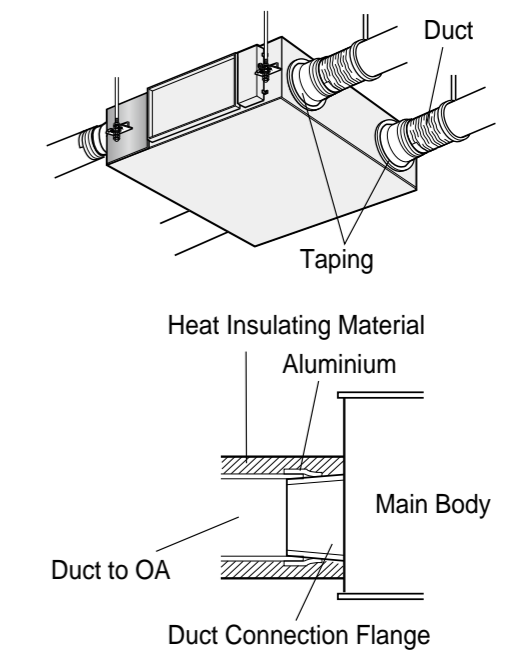

ERV

LZ-H025GBA4 / LZ-H035GBA5
LZ-H050GBA5



Model	Unit	LZ-H025GBA4	LZ-H035GBA5	LZ-H050GBA5		
Dimensions (W x H x D)	Body	988 x 273 x 1,014				
Weight	Body	44				
Power Supply	Ø, V, Hz	1, 220-240, 50				
Normal Air flow	m³/h	250	350	500		
ERV Mode	Operating Step	Super-high / High / Low				
	Current	SH / H / L	A	0.70 / 0.60 / 0.42	1.05 / 0.90 / 0.50	1.65 / 1.56 / 0.80
	Power Input	SH / H / L	W	97 / 87 / 52	150 / 125 / 60	247 / 230 / 95
	Air Flow	SH / H / L	m³/h	250 / 250 / 150	350 / 350 / 210	500 / 500 / 320
	External Static Pressure	SH / H / L	Pa	100 / 70 / 50	150 / 100 / 50	150 / 100 / 50
	Temperature Exchange Efficiency	SH / H / L	%	80 / 80 / 83	80 / 80 / 82	79 / 79 / 82
	Enthalpy Exchange Efficiency	Heating (SH / H / L)	%	70 / 70 / 72	75 / 75 / 80	75 / 75 / 78
		Cooling (SH / H / L)	%	66 / 66 / 68	71 / 71 / 75	68 / 68 / 75
	Energy Label	A+ to G Scale	A B B			
	Sound Pressure Level	SH / H / L	dB(A)	29 / 28 / 24	35 / 32 / 26	37 / 36 / 28
Sound Power Level	SH / H / L	dB(A)	50	53 / 50 / 42	57 / 56 / 46	
Bypass Mode	Operating Step	Super-high / High / Low				
	Current	SH / H / L	A	0.70 / 0.60 / 0.42	1.05 / 0.90 / 0.50	1.65 / 1.56 / 0.80
	Power Input	SH / H / L	W	97 / 87 / 52	150 / 125 / 60	247 / 230 / 95
	Air Flow	SH / H / L	m³/h	250 / 250 / 150	350 / 350 / 210	500 / 500 / 320
	External Static Pressure	SH / H / L	Pa	100 / 70 / 50	150 / 100 / 50	150 / 100 / 50
	Sound Pressure Level	SH / H / L	dB(A)	29 / 29 / 25	35 / 33 / 26	37 / 37 / 28
Duct Work	Qty	EA	4			
	Size (Ø)	mm	Ø200			
Supply Air Fan	Qty	EA	1			
	Type		Direct-Drive Sirocco			
Exhaust Air Fan	Qty	EA	1			
	Type		Direct-Drive Sirocco			
Filters	Qty	EA	2			
	Type		Cleanable fibrous fleeces			
	Size (W x H x D)	mm	855 x 10 x 166			

- Note : 1. ERV mode : Total Heat Recovery Ventilation mode
 2. Refer to dimensional drawings.
 3. Noise level :
 - The operating conditions are assumed to be standard
 - Sound measured at 1.5m below the center the body.
 - Sound level will vary depending on a range of factors such as the construction(acoustic absorption coefficient) of particular room in which the equipment is installed.
 - The sound level at the air discharge port is about 8 dB(A) higher than the unit's operating sound.
 4. Temperature and Enthalpy Exchange Efficiency at cooling Indoor Temperature : 26.5°C DB, 64.5% RH, Outdoor Temperature : 34.5°C DB, 75% RH
 5. Temperature and Enthalpy Exchange Efficiency at heating Indoor Temperature : 20.5°C DB, 59.5% RH, Outdoor Temperature : 5°C DB, 65% RH
 6. Temperature Exchange efficiency is tested at heating condition.

Accessories

Chassis	LZ-H025GBA4	LZ-H035GBA5	LZ-H050GBA5
Drain Pump	-	-	-
Cassette Cover	-	-	-
Refrigerant Leakage Detector	-	-	-
EEV Kit	-	-	-
Independent Power Module	-	-	-
Robot Cleaner	-	-	-
Pre Filter (Washable)	-	-	-
Ion Generator	-	-	-
CO ₂ Sensor	-	○	-
Ventilation Kit	-	-	-
IR Receiver	-	-	-
Zone Controller	-	-	-
Dry Contact (with additional accessory)	-	PDRYCB000 (1 point contact) PDRYCB500 (Modbus)	
External Input (1 point)	-	-	-
Wi-Fi	-	-	-

※ ○ : Applied, - : Not applied
 Option : Refer to model name in table

ERV

LZ-H080GBA5 / LZ-H100GBA5
LZ-H150GBA5 / LZ-H200GBA5



Model	Unit	LZ-H080GBA5	LZ-H100GBA5	LZ-H150GBA5	LZ-H200GBA5		
Dimensions (W x H x D)	Body	1,101 x 405 x 1,230		1,353 x 815 x 1,230			
Weight	Body	63		130			
Power Supply	Ø, V, Hz	1, 220-240, 50					
Normal Air flow	m³/h	800	1,000	1,500	2,000		
ERV Mode	Operating Step	Super-high / High / Low					
	Current	SH / H / L	A	2.13 / 1.75 / 1.00	2.92 / 2.38 / 1.40	4.26 / 3.50 / 2.00	5.92 / 4.76 / 2.80
	Power Input	SH / H / L	W	328 / 266 / 144	463 / 370 / 208	660 / 530 / 290	926 / 740 / 420
	Air Flow	SH / H / L	m³/h	800 / 800 / 660	1,000 / 1,000 / 800	1,500 / 1,500 / 1,200	2,000 / 2,000 / 1,600
	External Static Pressure	SH / H / L	Pa	160 / 100 / 50	160 / 100 / 50	160 / 100 / 50	160 / 100 / 50
	Temperature Exchange Efficiency	SH / H / L	%	82 / 82 / 83	80 / 80 / 81	82 / 82 / 83	80 / 80 / 81
	Enthalpy Exchange Efficiency	Heating (SH / H / L)	%	73 / 73 / 76	71 / 71 / 73	73 / 73 / 76	71 / 71 / 73
		Cooling (SH / H / L)	%	66 / 66 / 70	64 / 64 / 67	66 / 66 / 70	64 / 64 / 67
	Sound Pressure Level	SH / H / L	dB(A)	40 / 36 / 32	40 / 37 / 33	43 / 39 / 35	43 / 40 / 36
	Sound Power Level	SH / H / L	dB(A)	56 / 53 / 47	59 / 56 / 52	59 / 56 / 50	62 / 59 / 55
Bypass Mode	Operating Step	Super-high / High / Low					
	Current	SH / H / L	A	2.13 / 1.75 / 1.00	2.92 / 2.38 / 1.40	4.26 / 3.50 / 2.00	5.92 / 4.76 / 2.80
	Power Input	SH / H / L	W	328 / 266 / 144	463 / 370 / 208	660 / 530 / 290	926 / 740 / 420
	Air Flow	SH / H / L	m³/h	800 / 800 / 660	1,000 / 1,000 / 800	1,500 / 1,500 / 1,200	2,000 / 2,000 / 1,600
	External Static Pressure	SH / H / L	Pa	160 / 100 / 50	160 / 100 / 50	160 / 100 / 50	160 / 100 / 50
	Sound Pressure Level	SH / H / L	dB(A)	41 / 37 / 33	41 / 38 / 34	44 / 40 / 36	44 / 41 / 37
Duct Work	Qty	EA	4		4 + 2		
	Size (Ø)	mm	Ø250		Ø250 + Ø350		
Supply Air Fan	Qty	EA	1		2		
	Type		Direct-Drive Sirocco		Direct-Drive Sirocco		
Exhaust Air Fan	Qty	EA	1		2		
	Type		Direct-Drive Sirocco		Direct-Drive Sirocco		
Filters	Qty	EA	2		4		
	Type		Cleanable fibrous fleeces		Cleanable fibrous fleeces		
	Size (W x H x D)	mm	1,148 x 6 x 245		1,148 x 6 x 245		

- Note : 1. ERV mode : Total Heat Recovery Ventilation mode
 2. Refer to dimensional drawings.
 3. Noise level :
 - The operating conditions are assumed to be standard
 - Sound measured at 1.5m below the center the body.
 - Sound level will vary depending on a range of factors such as the construction(acoustic absorption coefficient) of particular room in which the equipment is installed.
 - The sound level at the air discharge port is about 8 dB(A) higher than the unit's operating sound.
 4. Temperature and Enthalpy Exchange Efficiency at cooling Indoor Temperature : 26.5°C DB, 64.5% RH, Outdoor Temperature : 34.5°C DB, 75% RH
 5. Temperature and Enthalpy Exchange Efficiency at heating Indoor Temperature : 20.5°C DB, 59.5% RH, Outdoor Temperature : 5°C DB, 65% RH
 6. Temperature Exchange efficiency is tested at heating condition.

Accessories

Chassis	LZ-H080GBA5	LZ-H100GBA5	LZ-H150GBA5	LZ-H200GBA5
Drain Pump	-	-	-	-
Cassette Cover	-	-	-	-
Refrigerant Leakage Detector	-	-	-	-
EEV Kit	-	-	-	-
Independent Power Module	-	-	-	-
Robot Cleaner	-	-	-	-
Pre Filter (Washable)	-	-	-	-
Ion Generator	-	-	-	-
CO ₂ Sensor	-	○	-	-
Ventilation Kit	-	-	-	-
IR Receiver	-	-	-	-
Zone Controller	-	-	-	-
Dry Contact (with additional accessory)	-	PDRYCB000 (1 point contact) PDRYCB500 (Modbus)		
External Input (1 point)	-	-	-	-
Wi-Fi	-	-	-	-

※ ○ : Applied, - : Not applied
 Option : Refer to model name in table

ERV WITH DX COIL

Providing Cool & Warm Fresh Air

During the summer, ERV DX can transform outdoor warm air into cool air for indoors, and it can prevent cold draft during the winter by supplying warm air.

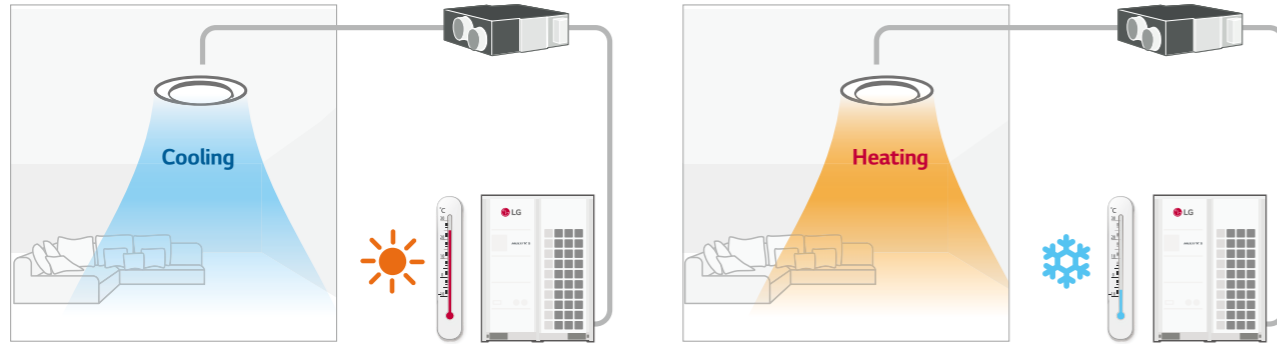

Total Air Conditioning Solution

LG ERV DX can be used as a Total Air Conditioning Solution. It can control condition of incoming air with the DX coil and humidifier for making comfortable indoor air. In the summer, LG ERV DX provides air conditioning by cooling and dehumidifying incoming air. During winter, warm air is provided by heating and humidifying incoming air.

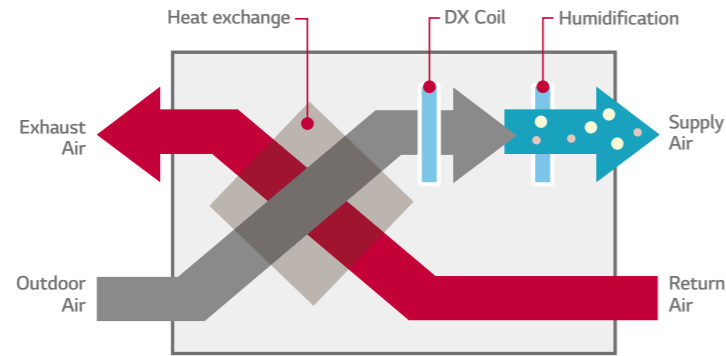

Interlocking with MULTI V

LG ERV DX can be interlocked with MULTI V. It can be controlled individually by a wired remote controller connected to MULTI V indoor units.

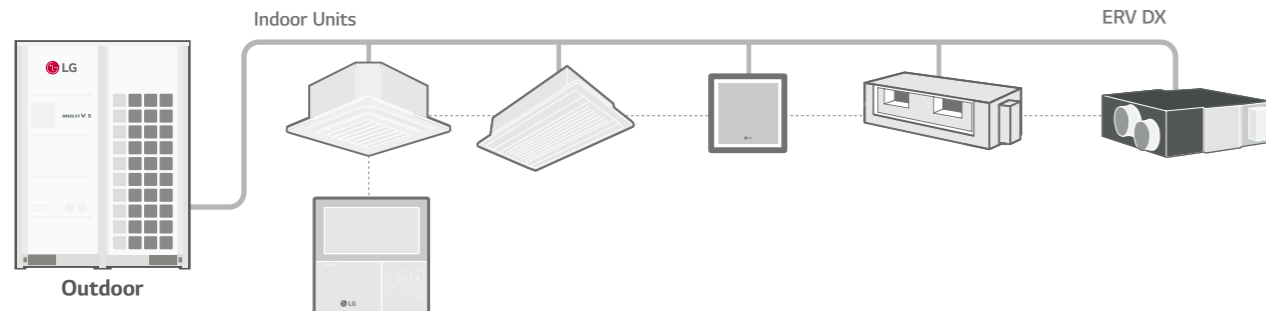

ERV WITH DX COIL

LZ-H050GXH4 / LZ-H080GXH4
LZ-H100GXH4 / LZ-H050GXN4
LZ-H080GXN4 / LZ-H100GXN4



Model		LZ-H050GXH4	LZ-H080GXH4	LZ-H100GXH4	LZ-H050GXN4	LZ-H080GXN4	LZ-H100GXN4
Fresh Air	Cooling	kW	4.93	7.46	9.12	4.93	7.46
Conditioning Load	Heating	kW	6.73	9.80	11.72	6.73	9.80
Temperature Exchange Efficiency	SH / H / L	%	86 / 86 / 87	80 / 80 / 81	76 / 76 / 78	86 / 86 / 87	80 / 80 / 81
Enthalpy Exchange Efficiency	Cooling (SH / H / L)	%	61 / 61 / 63	50 / 50 / 53	45 / 45 / 50	61 / 61 / 63	50 / 50 / 53
Operation Range	Heating (SH / H / L)	%	76 / 76 / 77	67 / 67 / 69	64 / 64 / 66	76 / 76 / 77	67 / 67 / 69
Air Flow Rate	Outdoor air Temperature	°C	-15 ~ 45	-15 ~ 45	-15 ~ 45	-15 ~ 45	-15 ~ 45
Fan	Heat Exchange Mode (SH / H / L)	CMH	500 / 500 / 440	800 / 800 / 640	1,000 / 1,000 / 820	500 / 500 / 440	800 / 800 / 640
	Bypass Mode (SH / H / L)	CMH	500 / 500 / 440	800 / 800 / 640	1,000 / 1,000 / 820	500 / 500 / 440	800 / 800 / 640
Humidifier	External Static Pressure (SH / H / L)	Pa	160 / 120 / 100	140 / 90 / 70	110 / 70 / 60	180 / 150 / 110	170 / 120 / 80
	System	Natural Evaporating Type	-	-	-	-	-
Sound Pressure	Amount	kg/h	2.70	4.00	5.40	-	-
	Pressure Feed Water	Mpa	-	0.02 ~ 0.49	-	-	-
Refrigerant	Heat Exchange Mode (SH / H / L)	dB(A)	38 / 36 / 33	39 / 37 / 34	40 / 38 / 35	39 / 37 / 35	41 / 38 / 36
	Bypass Mode (SH / H / L)	dB(A)	39 / 37 / 34	40 / 38 / 35	40 / 38 / 35	39 / 37 / 35	41 / 38 / 36
Power Supply	Refrigerant		R410A				
Power Input (Nominal)	Power Supply	∅, V, Hz	1, 220-240, 50, 60				
Nominal Running Current (RLA)	Heat Exchange Mode (SH / H / L)	kW	0.25 / 0.20 / 0.15	0.42 / 0.35 / 0.25	0.48 / 0.42 / 0.27	0.25 / 0.20 / 0.15	0.42 / 0.35 / 0.25
	Bypass Mode (SH / H / L)	kW	0.25 / 0.20 / 0.15	0.42 / 0.35 / 0.25	0.48 / 0.42 / 0.27	0.25 / 0.20 / 0.15	0.42 / 0.35 / 0.25
Heat Exchange System	Heat Exchange Mode (SH / H / L)	A	1.5 / 1.3 / 1.0	2.5 / 2.0 / 1.5	3.6 / 3.2 / 2.3	1.5 / 1.3 / 1.0	2.5 / 2.0 / 1.5
	Bypass Mode (SH / H / L)	A	1.5 / 1.3 / 1.0	2.5 / 2.0 / 1.5	3.6 / 3.2 / 2.3	1.5 / 1.3 / 1.0	2.5 / 2.0 / 1.5
Heat Exchange Element	Air to air cross flow total heat (Sensible + Latent heat) exchange		Air to air cross flow total heat (Sensible + Latent heat) exchange			Air to air cross flow total heat (Sensible + Latent heat) exchange	
	Specially processed non-flammable paper		Specially processed non-flammable paper			Specially processed non-flammable paper	
Air Filter	Multidirectional fibrous fleeces		Multidirectional fibrous fleeces			Multidirectional fibrous fleeces	
	Multidirectional fibrous fleeces		Multidirectional fibrous fleeces			Multidirectional fibrous fleeces	
Dimensions	W x H x D	mm	1,667 x 365 x 1,140			1,667 x 365 x 1,140	
	Net Weight	kg	105			98	
Piping Connection	Liquid	mm	∅6.35			∅6.35	
	Gas	mm	∅12.7			∅12.7	
	Water	mm	∅6.35			-	
Connection Duct Diameter	Drain Pipe (Internal Dia.)	mm (inch)	∅25 (1)			∅25 (1)	
		mm	∅250			∅250	

Note : 1. Cooling Capacity Test condition - Indoor temperature : 27°C DB, 19°C WB / Outdoor temperature : 35°C DB
2. Heating Capacity Test condition - Indoor temperature : 20°C DB / Outdoor temperature : 7°C DB, 6°C WB
3. Humidifying capacity is based on the following conditions - Indoor temperature : 20°C DB, 15°C WB / Outdoor temperature : 7°C DB, 6°C WB
4. Cooling and heating capacities are based on the following conditions. ; Fan is based on High and Super-high.
5. The operating sound measured at the point 1.5 m below the center of the unit is converted to that measured at an anechoic chamber.
6. The specifications, designs and information here are subject to change without notice.

Accessories

Chassis	LZ-H050GXH4	LZ-H080GXH4	LZ-H100GXH4	LZ-H050GXN4	LZ-H080GXN4	LZ-H100GXN4
Drain Pump	-	-	-	-	-	-
Cassette Cover	-	-	-	-	-	-
Refrigerant Leakage Detector	-	-	-	PRLDNV50	-	-
EEV Kit	-	-	-	-	-	-
Independent Power Module	-	-	-	-	-	-
Robot Cleaner	-	-	-	-	-	-
Pre Filter (Washable)	-	-	-	-	-	-
Ion Generator	-	-	-	-	-	-
CO ₂ Sensor	-	-	-	AHCS100H0	-	-
Ventilation Kit	-	-	-	-	-	-
IR Receiver	-	-	-	-	-	-
Zone Controller	-	-	-	-	-	-
Dry Contact (with additional accessory)	-	-	-	PDRYCB000 (1 point contact)	-	-
External Input (1 point)	-	-	-	PDRYCB500 (Modbus)	-	-
Wi-Fi	-	-	-	-	-	-

※ ○ : Applied, - : Not applied
Option : Refer to model name in table

CONTROL SOLUTIONS

INDIVIDUAL CONTROL / CENTRALIZED CONTROL
INTEGRATION DEVICE



LG CONTROL SOLUTIONS

MULTI V 5 offers a diverse range of effective control solutions that satisfy specific needs of each building and its user scene. These control systems are equipped with user-friendly interface, flexible interlocking environment, energy management and smart individual controller for optimized controlling conditions and smart building management.

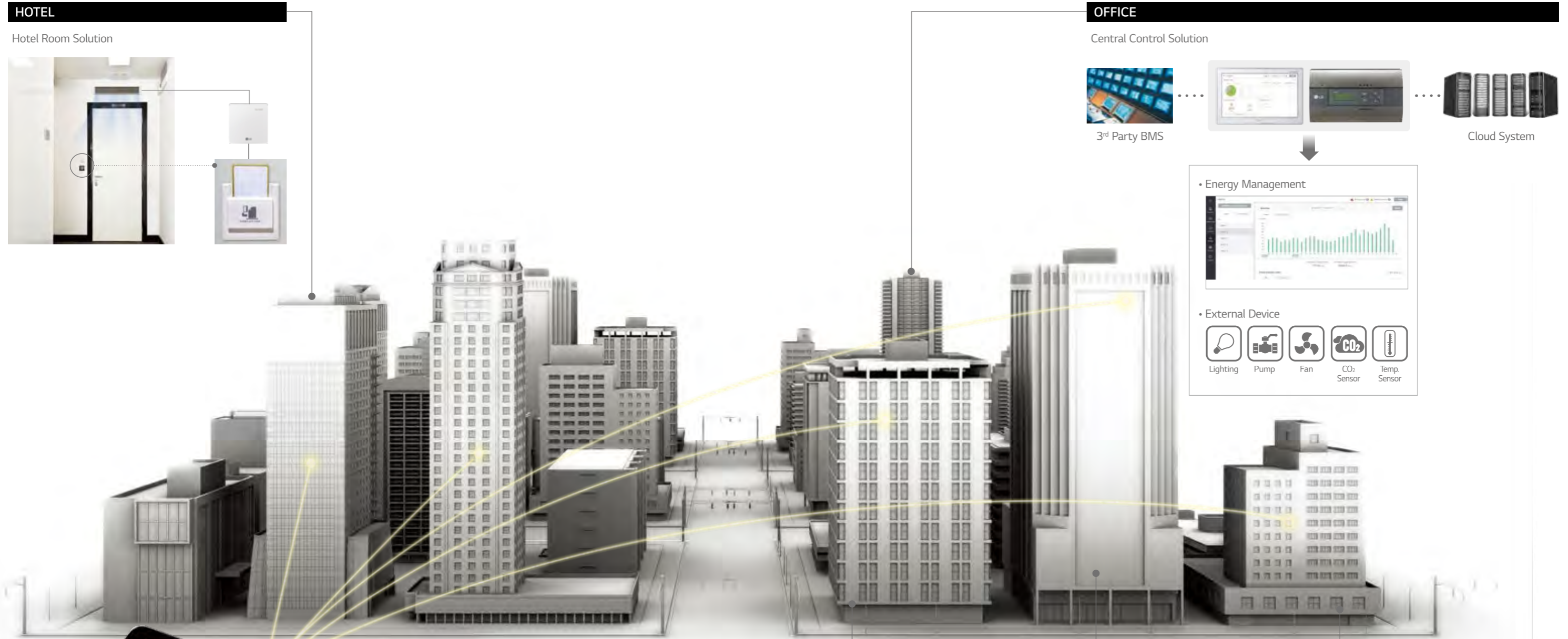

HOTEL

Hotel Room Solution



OFFICE

Central Control Solution



• Energy Management

• External Device

- Lighting
- Pump
- Fan
- CO₂ Sensor
- Temp. Sensor

APARTMENT

Power Distribution Solution



RESIDENTIAL

Smart Individual Control Solution



SMALL BUILDING

Small Central Control Solution



Integration Solution



CONTROL SOLUTIONS

INDIVIDUAL CONTROL



FEATURE FUNCTIONS

Controller Name	Wired Remote Controller					Wireless Remote Controller	Wi-Fi Controller
	Premium	Standard III	Standard II	Simple	Simple(Hotel)		
Model Name	PREMTA000 PREMTA000A PREMTA000B	PREMTB100 PREMTBB10	PREMTB001 PREMTBB01	PQRCVCL0Q PQRCVCL0QW	PQRCHCA0Q PQRCHCA0QW	NEW PWLSSB21H (H/P)	PWFMD200
On / Off	○	○	○	○	○	○	○
Fan Speed Control	○	○	○	○	○	○	○
Temperature Setting	○	○	○	○	○	○	○
Mode Change	○	○	○	○	-	○	○
Auto Swing	○	○	○	○	○	○	
Vane Control (Louver Angle)	○	○	○	○	○	○	○
E.S.P (External Static Pressure)	○	○	○	○	○	-	-
Electric Failure Compensation	○	○	○	○	○	-	○
Indoor Temperature Display	○	○	○	○	○	○	
ALL Button Lock (Child Lock)	○	○	○	○	○	-	-
Schedule / Timer	Weekly - Yearly	Weekly - Yearly	Weekly	-	-	Sleep / On / Off	Weekly
Additional Mode Setting ¹⁾	○	○	○	-	-	-	-
Time Display	○	○	○	-	-	○	-
Humid. Display	○	○	-	-	-	-	-
Advanced Lock (Mode, Set point, Set point range, On / Off Lock)	Advanced Lock	Advanced Lock	-	-	-	-	-
Filter Sign	○	○	○	-	-	-	-
Energy Management ²⁾	○	○	○	-	-	-	-
Dual Set Point	○	○	-	-	-	-	-
Human Detection	-	○	-	-	-	-	-
Temp, Humidity Compensation	○	○	-	-	-	-	-
Wi-Fi AP Mode Setting	○	○	○	○	○	○	-
Operation Status LED	○	○	○	○	○	-	-
Wireless Remote Controller Receiver	○ ³⁾	-	○ ³⁾	○ ³⁾	○ ³⁾	-	-
Display	5 inch Color	4.3 inch Color	4.3 inch mono	2.6 inch mono	2.6 inch mono	2 inch mono	-
Size (W x H x D, mm)	137 x 121 x 16.5	120 x 120 x 16	120 x 120 x 16	64 x 120 x 15	64 x 120 x 15	51 x 153 x 26	-
Black Light Control for Screen Saver	○	○	-	-	-	-	-

※ ○ : Applied, - : Not Applied

1) It might not be indicated or operated at the partial product

2) Centralized control (PACEZA000 / PACSSA000 / PACPSA000 / PLNWK000) and PDI (PQNUD1S40 / PPWRDB000) should be installed for this function

3) For ceiling type duct

Note : 1. Indoor unit should have functions requested by the controller

2. If you need more detail, please refer to the manual of product. (<http://partner.lge.com: Home > Doc.Library > Manual>)

STANDARD III WIRED REMOTE CONTROLLER

4.3 inch colored screen with modern design



PREMTB100 (White) PREMTBB10 (Black)

Features & Benefits

- The optimized controller for MULTI V 5
 - Humidity sensor embedded
 - Comfort cooling setting
 - Smart Load Control setting
 - Outdoor unit low noise setting
 - Defrost mode setting
- New modern design & easy interface
 - Seamless design / Touch button
 - 4.3 inch color LCD / Intuitive GUI
- Energy saving functions
 - Instantaneous power monitor
 - Energy consumption check (Power consumption, operation time)
 - Temp. Setback timer, time limit control
 - Target setting (ODU capacity, Instantaneous power)
- Group control
 - Up to 16 Indoor units can be controlled with one remote control
- External device On / Off (1 point)
 - Customized interlocking control with indoor unit is possible without dry contact
- 2 set points control
 - Increase convenience and comfort
 - Auto changeover, Setback (home leave)

Model Name	PREMTB100 / PREMTBB10
On / Off	○
Fan Speed Control	○
Temperature Setting	○
Mode Change	Cooling / Heating / Auto / Dehumidification / Fan Energy-Saving Cooling / Robot Cleaning / Heater / Humidification / Comfort Cooling
Additional Mode Setting ¹⁾	
Auto Swing	○
Vane Control (Lower direction)	○
E.S.P (External Static Pressure) ²⁾	○
Reservation	Simple / Sleep / On & Off timer / Weekly / Yearly / Holiday
Time Display	○
Electric Failure Compensation	○
Lock	All / On & Off / Mode / Set temperature range
Filter Sign	○ (Remain time + Alarm)
Energy Management	Check Energy Usage ³⁾ / Check Operation Time / Target Setting (Energy, Operation Time) / Time Limit Operation / Alarm Popup / Initialization Usage Data
Operation Status LED	○
Indoor Temperature Display	○
Indoor Humidity Display	○
Human Detection	○
Display	4.3 inch TFT color LCD (480 x 272)
Size (W x H x D, mm)	120 x 120 x 16
Black light for Screen saver	○
Home Leave	2 set points control

※ ○ : Applied, - : Not Applied
 1) It might not be indicated or operated at the partial product
 2) This function is available for duct type
 3) This function requires PDI (PQNUD1S40 / PPWRDB000) to be installed.
 Note : 1. Indoor unit needs to have functions requested by the controller
 2. 2 set points control works normally with MULTI V Heat Recovery and Single Split Heat Pump. But in case of MULTI V Heat Pump, it may not work properly

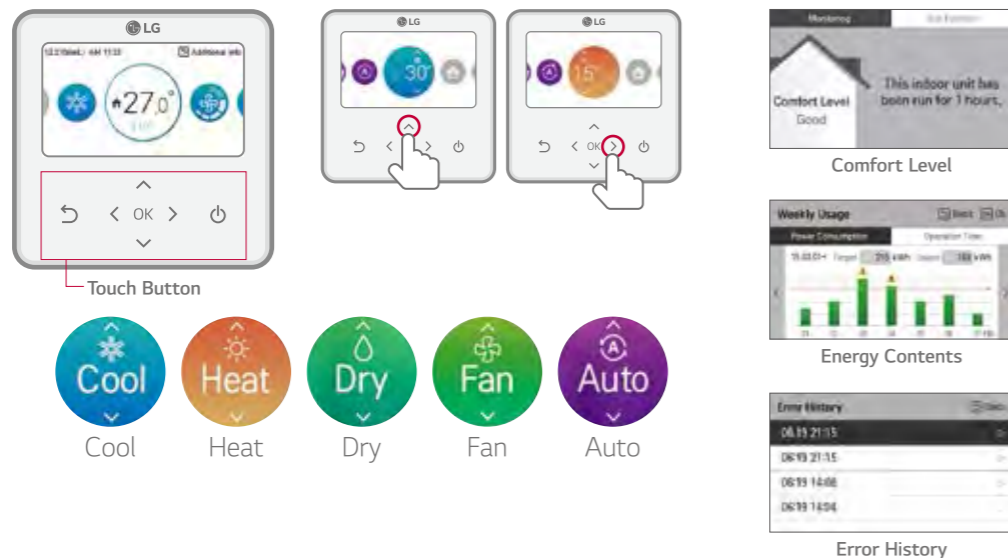

Energy Savings

Energy Management

- Energy Monitoring & Alarm
 Real-time and day / week / month / year energy usage monitoring is possible. In addition, it can set target for energy usage and operation time, and alarm will be displayed when exceeded.

※ PDI (PQNUD1S40 / PPWRDB000) is required.

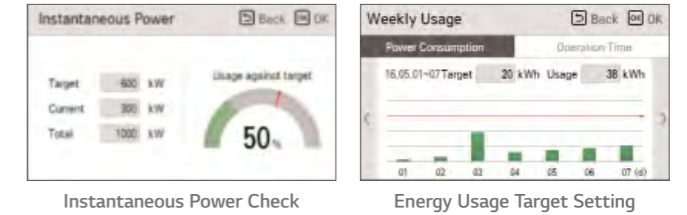

Time Limit Control

- The time-limit operation controls product by amount of time. By setting the device operation time in advance, users can control for how long a device works and have it stop automatically.



2 Set Points Control

Auto Changeover for convenience

- With 2 set points control function, indoor unit manages room temperature automatically.

Setback for energy savings and comfort

- In the user's absence, the room temperature will remain between two set points rather than switching off providing quick comfort when the mode is changed to occupied.

※ This function is for Heat Recovery system or Single heat pump. Otherwise it is not guaranteed.

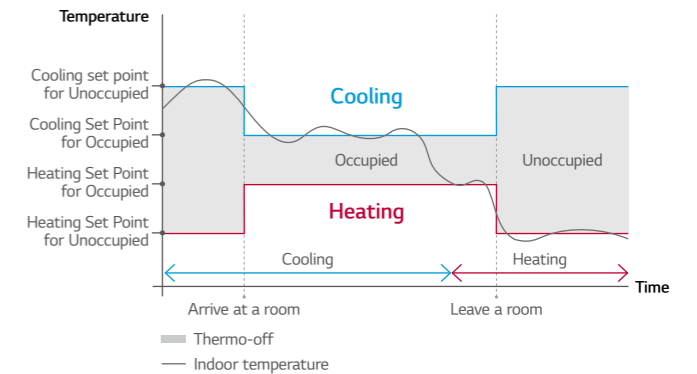

External Device On / Off



External Equipment Control
 User can turn the external equipment off or on through contact point output.

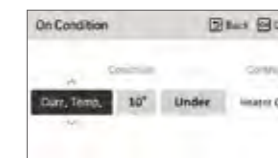

Customized Interlocking Control
 User can create a control scenario where the external heater switches on when temperature drops below or rises above a certain temperature.

Schedule Function



Simple Schedule Status

Standard III remote controller provides clock type daily schedule.

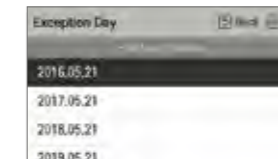

Exception Day settings

Possible to set up exceptional date on regular schedule.

CONTROL SOLUTIONS INDIVIDUAL CONTROL

PREMIUM WIRED REMOTE CONTROLLER

5 inch full touch screen with a premium design.



PREMTA000 ¹⁾ / PREMTA000A ²⁾ / PREMTA000B ³⁾

- 1) English / Portuguese / Spanish / French
- 2) English / Italian / Russian / Chinese
- 3) English / German / Polish / Czech

Features & Benefits

- Full Touch screen
- The optimized controller for MULTI V 5
 - Comfort cooling setting
 - Smart Load Control setting
 - Outdoor unit low noise setting
 - Defrost mode setting
- Design with user's convenience
 - Intuitive GUI
 - Main display simple mode
 - 5 inch color LCD
- Energy saving functions
 - Instantaneous power monitor
 - Energy consumption check (Power consumption, operation time)
 - Temp. Setback timer, Time limit control
 - Target setting (ODU capacity, Instantaneous power...etc)
- Group control
 - Up to 16 Indoor units can be controlled with one remote control
 - 2 set points control
 - Increase convenience and comfort
 - Auto changeover, Setback (Home leave)



Full Touch Screen

Easy Energy Management

- Check the operation hour or electricity usage
- Comparison of usage compared to last year
- Set the target usage and time

Easy Scheduling

- Daily, Weekly, Yearly schedule function
- Schedule pattern setting
- Schedule copy

2 Set points Control

- Auto changeover switching the operation mode automatically
- Setback (Home Leave) Changing status by occupied / unoccupied
- * This function is only for Heat Recovery system and Single heat pump.

Group Control

- Max. 16 Indoor units by one remote controller.

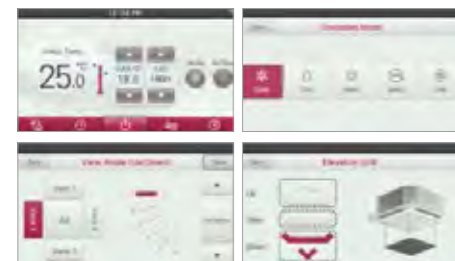

Model Name	PREMTA000 / PREMTA000A / PREMTA000B
On / Off	○
Fan Speed Control	○
Temperature Setting	○
Mode Change	Cooling / Heating / Auto / Dehumidification / Fan
Additional Mode Setting ¹⁾	Energy-Saving Cooling / Robot Cleaning / Heater / Humidification
Auto Swing	○
Vane Control (Louver direction)	○
E.S.P (External Static Pressure) ²⁾	○
Reservation	Simple / Sleep / On / Off / Weekly / Yearly / Holiday
Time Display	○
Electric Failure Compensation	○
Child Lock	○
Filter Sign	○ (Remain time + Alarm)
Energy Management	Check Energy Usage ³⁾ / Check Operation Time / Target Setting (Energy, Operation Time) / Time Limit Operation / Alarm Popup / Initialization Usage Data
Operation Status LED	○
Indoor Temperature Display	○
Wireless Remote Controller Receiver	○ ⁴⁾
Display	5 Inch TFT color LCD (480 x 272)
Size (W x H x D, mm)	137 x 121 x 16.5
Black Light for Screen Saver	○
Home Leave	2 Set Points Control

※ ○ : Applied, - : Not Applied

1) It might not be indicated or operated at the partial product

2) This function is available for duct type

3) This function requires PDI (PQNUD1S40 / PPWRDB000) to be installed.

4) For ceiling type ducted unit

Note : 1. Indoor unit needs to have functions requested by the controller
2. 2 set points control works normally with MULTI V Heat Recovery and Single Split Heat Pump. But in case of MULTI V Heat Pump, It may not work properly

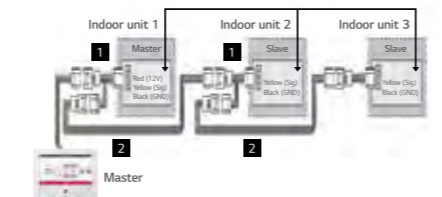
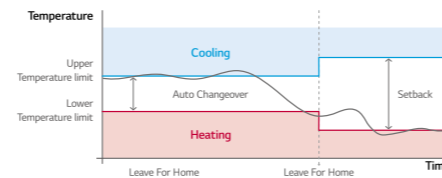

STANDARD II WIRED REMOTE CONTROLLER

Providing easy control of one or a group of indoor units with various functions.



PREMTB001 (White) PREMTBB01 (Black)

Features & Benefits

- Wired remote controller that can implement various functions such as scheduling or filter alert.

Model Name	PREMTB001 / PREMTBB01
On / Off	○
Fan Speed Control	○
Temperature Setting	○
Mode Change	Cooling / Heating / Auto / Dehumidification / Fan
Additional Mode Setting	Energy-Saving Cooling / Robot Cleaning / Heater / Humidification
Auto Swing	○
Vane Control (Louver direction)	○
E.S.P (External Static Pressure)	○
Reservation	Simple / Sleep / On / Off / Weekly / Holiday
Time Display	○
Electric Failure Compensation	○
Child Lock	○
Filter Sign	○ (Remain time + Alarm)
Operation Status LED	○
Indoor Temperature Display	○
Wireless Remote Controller Receiver	○ ¹⁾
Size (W x H x D, mm)	120 x 120 x 16
Blacklight	○
Power Consumption Monitoring	○ ²⁾
Check Model Information	○

※ ○ : Applied, - : Not Applied

1) For ceiling type ducted unit

2) This function requires PDI (PQNUD1S40 / PPWRDB000) to be installed.

Note : Indoor unit needs to have functions requested by the controller

SIMPLE WIRED REMOTE CONTROLLER

A simple way to control office or hotel systems in a compact design.



PQRCVCL0QW (White) / PQRCHCA0QW (White) / PQRCHCA0Q (Black)

Features & Benefits

- Small remote control with minimal functionality

Model Name	PQRCVCL0QW / PQRCHCA0QW	PQRCHCA0QW / PQRCHCA0Q
On / Off	○	○
Fan Speed Control	○	○
Temperature Setting	○	○
Mode Change	Cooling / Heating / Auto / Dehumidification / Fan	-
Auto Swing	○	○
Vane Control (Louver direction)	○	○
E.S.P (External Static Pressure)	○	○
Electric Failure Compensation	○	○
Child Lock	○	○
Indoor Temperature Display	○	○
Wireless Remote Controller Receiver	○ ¹⁾	○ ¹⁾
Size (W x H x D, mm)	70 x 121 x 16	70 x 121 x 16
Blacklight	○	○

※ ○ : Applied, - : Not Applied

1) For ceiling type ducted unit

Note : Indoor unit needs to have functions requested by the controller

WIRELESS REMOTE CONTROLLER



NEW
PWLSSB21H (H/P)

Features & Benefits

- Easy to use while moving
- Main functions are available

Model Name	PWLSSB21H (H/P)
On / Off	○
Fan Speed Control	○ ¹⁾
Temperature Setting	○
Mode Change	Cooling / Heating / Auto / Dehumidification / Fan
Additional Mode Setting	Plasma Purification / Energy-Saving Cooling / Robot Cleaning / Auto Dry
Auto Swing	○
Vane Control (Louver direction)	○
Reservation	Sleep / On / Off
Time Display	○
Indoor Temperature Display	○
Sleep Mode Auto	Max. 7 hours
Size (W x H x D, mm)	51.4 x 153 x 26

※ ○ : Applied, - : Not Applied

1) For some products, you can use "slow" fan speed function.

LG Wi-Fi MODEM

Control LG air conditioners by using internet devices as Android or iOS smartphones.



PWFMD200

Model Name	PWFMD200
Size (W x H x D, mm)	48 x 68 x 14
Interfaceable Products	MULTI V Indoor unit ³⁾
Connection Type	Indoor unit 1:1
Communication Frequency	2.4 GHz
Wireless Standards	IEEE 802.11b/g/n
Mobile Application	LG ThinQ (Android v4.1(Jellybean) or higher, iPhone iOS 9.0 or higher)
Optional Extension Cable	PWYREW000 (10m extension)

1) Vane Control may not be possible according to the type of Indoor unit
 2) LG Centralized controller and PDI installation is required for this function
 3) For the compatibility with Indoor unit, please contact regional LG office
 Note : 1. Functionality may be different according to each IDU model
 2. User interface of application shall be revised for its design and contents improvement
 3. Application is optimized for smartphone use, so it may not be well functioning with tablet devices

Features & Benefits

- User can enjoy anytime, anywhere access with Wi-Fi equipped device through LG's ThinQ mobile app.
- This allows the user to access the unit remotely to switch unit on or off before or after leaving the vicinity.
- LG's exclusive Home Appliances control app (LG ThinQ) is available
- Simple operation for various functions
 - On / Off
 - Operation Mode
 - Current/Set Temperature
 - Fan Speed
 - Vane Control¹⁾
 - Reservation (Sleep, Weekly On / Off)
 - Energy Monitoring²⁾
 - Filter Management
 - Error Check

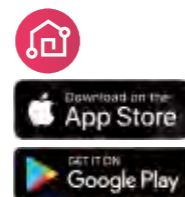

Overview

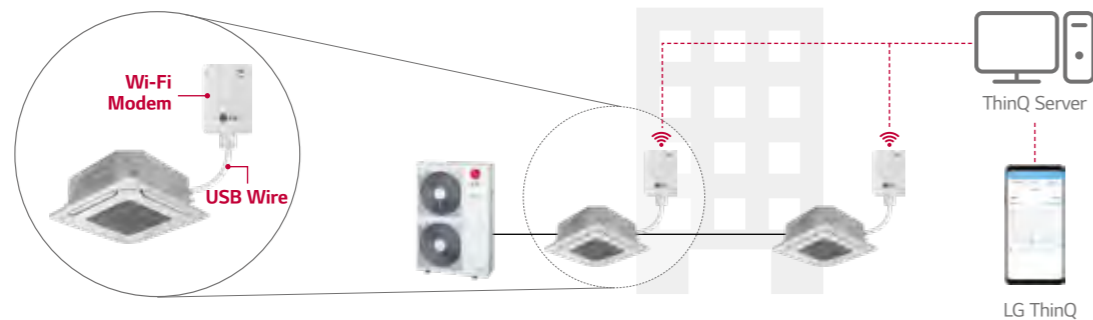

※ Search "LG ThinQ" on Google market or Appstore then download the app.
 ※ Internet service with Wi-Fi connection has to be available.

Installation Scene

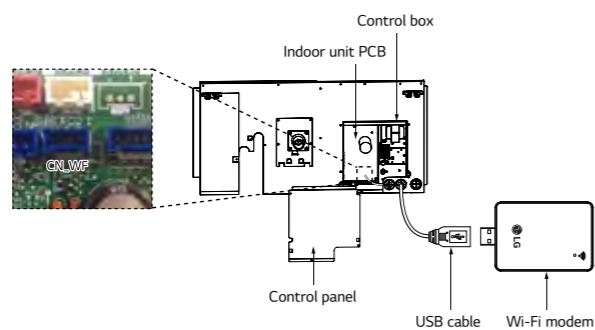

※ Each indoor unit has a Wifi modem installation location inside the product, and it can be installed by exposure if necessary.

LG ThinQ Connectivity

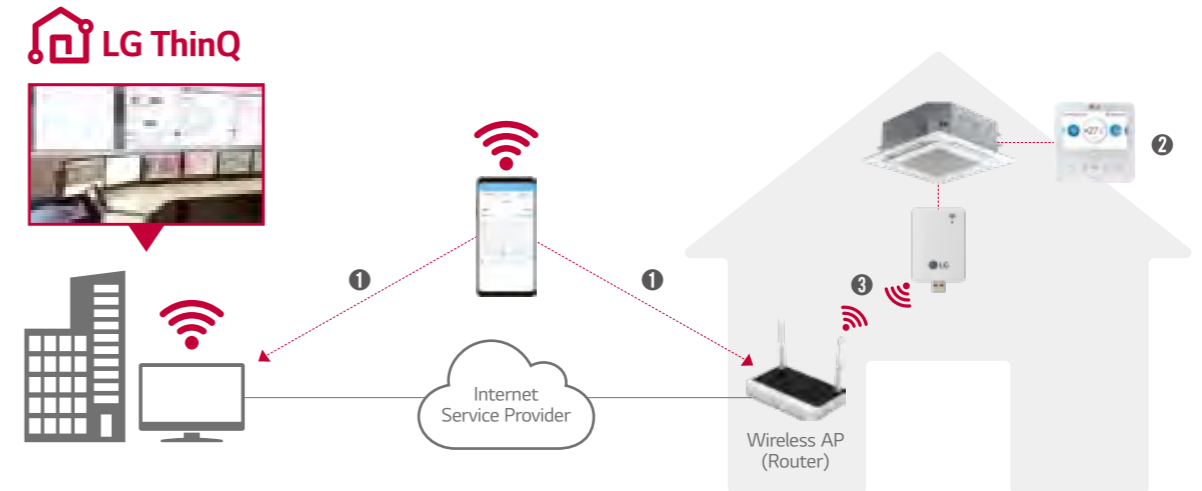

Connection (Pairing) Order

- 1 Make LG account on LG ThinQ and select the Router that will be used
- 2 Insert passwords of selected router and set AP (Access Point) by LG remote controller
- 3 Confirm the pairing between Wi-Fi Modem and Router

ThinQ Mobile App

Simple operation for various functions

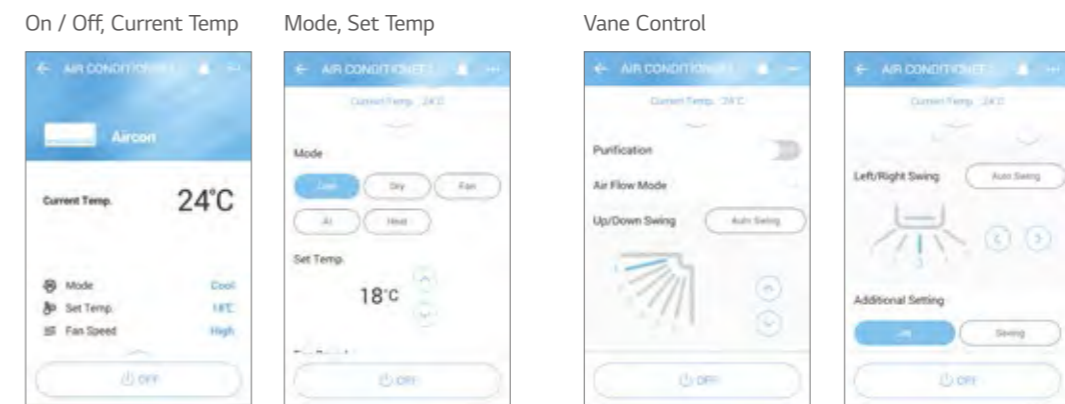

Easy Management



CENTRALIZED CONTROL



CENTRALIZED CONTROLLER FEATURE LIST

Controller Name		AC Ez	AC Ez Touch	AC Smart 5 ³⁾	ACP 5 ³⁾	ACP Lonworks	AC Manager 5 ³⁾
Model Name							
		PQCSZ250S0	PACEZA000	PACSSA000	PACP5A000	PLNWK000	PACM5A000
Product	DO	-	-	2	4	2	-
	DI	-	1	2	10	2	-
	IDUs	32	64	128	256	64	8,192
	Max. Connectable No.	32	64	128	256	64	8,192
	A/C + ERV	32	64	128	256	64	8,192
	AHU	-	-	16	16	16 ⁴⁾	16 x 32
Compatibility	Chiller	-	-	5 Optional ²⁾	10 Optional ²⁾	-	10 x 32
	Air Conditioner	○ ¹⁾	○	○	○	○	○
	Ventilation (ERV / ERV DX)	○ ²⁾	○	○	○	○	○
	Heating	-	○	○	○	○	○
	AHU	-	-	○	○	○	○
	Chiller	-	-	○ ⁴⁾	○ ⁴⁾	-	○
	ACS IO	-	-	○ ⁴⁾	○ ⁴⁾	○ ⁴⁾	○
	Add Drawing	-	-	○ ⁴⁾	○ ⁴⁾	○ ⁴⁾	○
	Group Management	-	-	○ ⁴⁾	○ ⁴⁾	○ ⁴⁾	○
	Auto Changer Over	-	○	○ ⁴⁾	○ ⁴⁾	○ ⁴⁾	○
Additional Function	Set Back	-	○	○ ⁴⁾	○ ⁴⁾	○ ⁴⁾	○
	2 Set	-	○	○	○	○ ⁴⁾	○
	Change Alarm	-	Filter	Filter	Filter	Filter	Filter
	Indoor Unit Lock	-	○	○	○	○ ⁴⁾	-
	Cycle	-	-	○	○	○ ⁴⁾	○
Schedule	Peak Control	○	○	○ ⁴⁾	○ ⁴⁾	○ ⁴⁾	○
	Priority Control	-	○	○	○	○ ⁴⁾	○
	Outdoor Unit Capacity Control	-	-	○ ⁴⁾	○ ⁴⁾	○ ⁴⁾	○
	Time limit control	-	-	○ ⁴⁾	○ ⁴⁾	○ ⁴⁾	○
Energy Navigation	InterLocking	-	-	○ ⁴⁾	○ ⁴⁾	○ ⁴⁾	○
	Power	-	○	○	○	○ ⁴⁾	○
	Gas	-	-	○	○	○ ⁴⁾	○
Energy Report	Run time	-	-	○ ⁴⁾	○ ⁴⁾	○ ⁴⁾	○
	Email	-	-	-	-	○ ⁴⁾	-
	PC / USB	-	-	○ ⁴⁾	PC	PC	PC
	Trend Reporting	-	-	-	-	-	○
History	Report (Control / Error)	-	Error	○ ⁴⁾	○ ⁴⁾	○ ⁴⁾	○
	Send Email	-	-	○ ⁴⁾	○ ⁴⁾	○ ⁴⁾	○
	Save to PC / USB ⁶⁾	-	-	-	-	○ ⁴⁾	-
etc	Summer Time	-	○	○ ⁴⁾	○ ⁴⁾	○ ⁴⁾	○
	Outdoor Unit Oil-Return Operation	-	-	○ ⁴⁾	○ ⁴⁾	○ ⁴⁾	-
	User Authority	-	Password	○ ⁴⁾	○ ⁴⁾	○ ⁴⁾	○
	PC Access	-	○	○ ⁴⁾	○ ⁴⁾	○ ⁴⁾	○

※ ○ : Applied, - : Not Applied
 1) Except for some feature (individual lock, limit, temp., etc.)
 2) Except for some feature (user mode, additional function, etc.)
 3) ACP 5 or AC Smart 5 is required
 4) This function is possible to use in Web Only (BMS Point is not applied)
 5) Without additional device, ACP 5 and AC Smart 5 provide BACnet IP and Modbus TCP interface for BMS
 6) Save to PC / USB function will be available from 4Q 2020

CONTROL SOLUTIONS CENTRALIZED CONTROL

AC EZ TOUCH

Smart management with 5 inch touch screen for small site.



PACEZA000

Model Name	PACEZA000
Size (W x H x D, mm)	137 x 121 x 25
Interfaceable Products	MULTI V / ERV / ERV DX / HYDRO KIT / THERMA V
Maximum number of units	64
Individual / Group Control	On & Off / Mode / Temperature / Fan speed
Individual Controller Lock	Temperature / Mode / Fan speed / All
Error Check	○
Slave Mode (Interlocking with higher level controller)	○
Schedule	Weekly / Monthly / Yearly / Exception day
Remote Access	By client S/W
Emergency Stop & Alarm Display	○
Power Consumption Monitoring (with PDI)	○
Auto Changeover / Setback	○
Temperature Limit	○
Operation History	Error record
ODU Low Noise ¹⁾	○
Daylight Saving Time	○
External IO Port	DI 1
IPv6 Support	○

※ ○ : Applied, - : Not Applied
1) It is only available in some products

Features & Benefits

- User-friendly control with iconographic interface
- Total 200 schedule events
- Energy saving mode
- Energy monitoring (with PDI)
- 2 set point function (Upper / Lower temperature setting)
- Temperature set points range limit
- Remote controller lock (All, Temp, Mode, Fan Speed)
- Operation history
- Clean or change filter alert
- Emergency stop

Overview

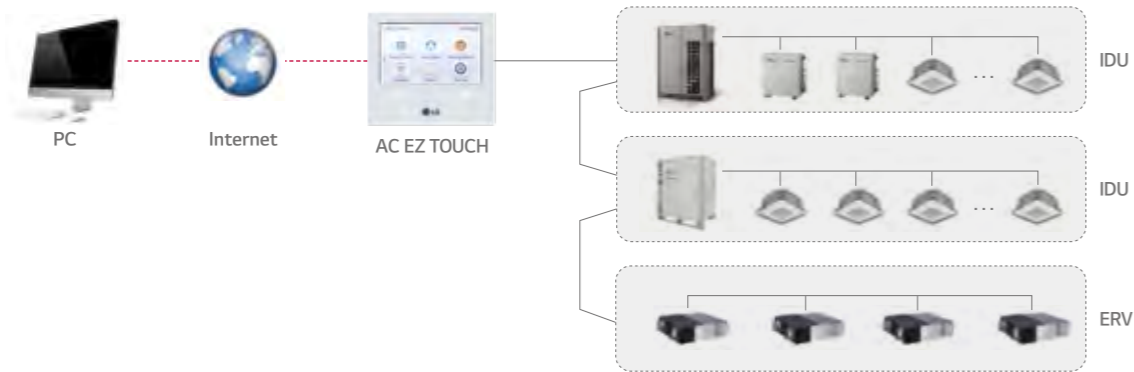

Feature

PC Access

Users can control each space efficiently through PC access.



* IPv6 supported

Energy Statistics (with PDI)

Statistics of operational status (Time, Power consumption) are provided to help make intelligent system operation decisions.

Energy		
2016. 2. 8 ~ 2016. 3. 19		
	Today	Week
Name	Usage(kWh)	Accumulated(kWh)
Group1	110	3021
Group2	150	6186
Group3	130	4267
Group4	120	7614

* Fix Public IP is mandatory
* Router's Configuration of NAT is mandatory. Open port 80 & 9300

Energy Mode

When using energy mode function, operation mode changes from cooling to fan or heating to off mode by force. (It is available only for operating indoor unit)



Schedule

Schedule control allows user to set the events in advance to maximize system performance. Also, by blocking unnecessary operation, it prevents a waste of energy.

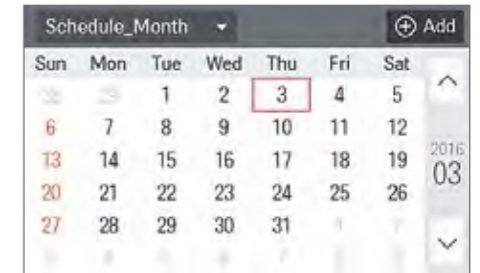

Alarm Indicator

It shows errors and alarm information. Users can respond immediately according to alarm indicator therefore HVAC system is monitored consistently.

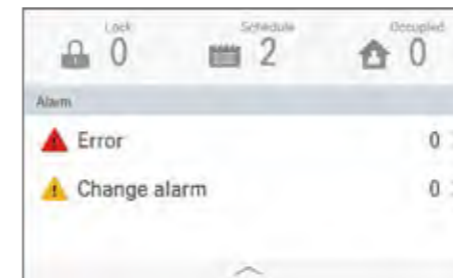

Group / Individual Control

User can control each indoor unit individually or by group by simply clicking each unit on control screen.



AC EZ

Easy to manage up to 32 indoor units, including ERV with simple interface.



PQCSZ250S0

Model Name	PQCSZ250S0
Size (W x H x D, mm)	190 x 120 x 20
Interfaceable Products	MULTI V / ERV / ERV DX
Display	LED / LCD Display
Power	DC 12V
Maximum number of units	32
Individual / Group Control	On & Off / Mode / Temperature / Fan speed
Individual Controller Lock	All
Error Check	○
Slave Mode (Interlocking with higher level controller)	○
Schedule	Weekly

※ ○ : Applied, - : Not Applied

Features & Benefits

- 32 indoor units control
- Weekly Schedule
- Individual / Group Control

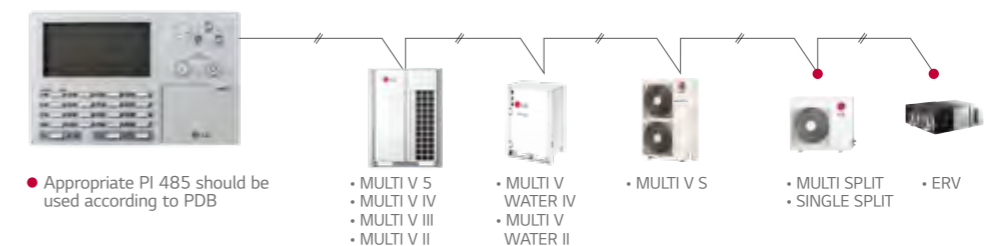

• Appropriate PI 485 should be used according to PDB

- MULTI V 5
- MULTI V IV
- MULTI V III
- MULTI V II
- MULTI V WATER IV
- MULTI V WATER II
- MULTI V S
- MULTI SPLIT
- SINGLE SPLIT
- ERV

AC SMART 5

10-inch touch screen with HTML5 GUI (Graphic User Interface) for easy control.



PACS5A000

Features & Benefits

- The central controller allows control of the LG HVAC system to various platforms. (Touch screen, PC, Smartphone, Tablet)
- DI : 2 / DO : 2
- Max. 128 IDU control
- BACnet IP/Modbus TCP
- Schedule
- Map view (Visual navigation)
- Time limit control / Auto change over
- Energy monitoring
- History / Operation trend
- Interlock with 3rd party equipment (ACS IO, ACU IO Module is needed)
- Multi level grouping
- Emergency stop & alarm
- Error alarm by e-mail

Model Name	PACS5A000
Size (W x H x D, mm)	253.2 x 167.7 x 28.9
Interfaceable Products	MULTI V / ERV / ERV DX / HYDRO KIT / THERMA V / AHU kit / LG Chiller ¹⁾
Maximum number of units	128
Individual / Group Control	On & Off / Mode / Temperature / Fan speed
Individual Controller Lock	Temperature / Mode / Fan speed / All
Advanced Function Setting and Display ²⁾	Comfort Cooling / ODU Low Noise / ODU Defrost Mode / Comfort Level display / CO ₂ Level display (for ERV / ERV DX) / Night Time Free Cooling (for ERV / ERV DX)
Error Check	○
Slave Mode (Interlocking with higher level controller)	○
Schedule	Weekly / Monthly / Yearly / Exception day
Web Access	○
Emergency Stop & Alarm Display	○
Power Consumption Monitoring (with PDI)	○
Auto Changeover / Setback	○
Temperature Limit	○
Operation Time Limit	○
Visual Navigation	○
Operation Trend	○
Interlock Control	○
Virtual Group Control	○
ODU Capacity Control	○
Energy Navigation (with PDI)	○
Daylight Saving Time	○
External IO Port	DI 2 / DO 2
BMS Integration ³⁾	BACnet IP / Modbus TCP
IPv6 Support	○

※ ○ : Applied, - : Not Applied
 1) Chiller Option Kit (PCHLLN000) is required
 2) It is only available in some products
 3) For the detail point list, please refer to the installation manual

Overview

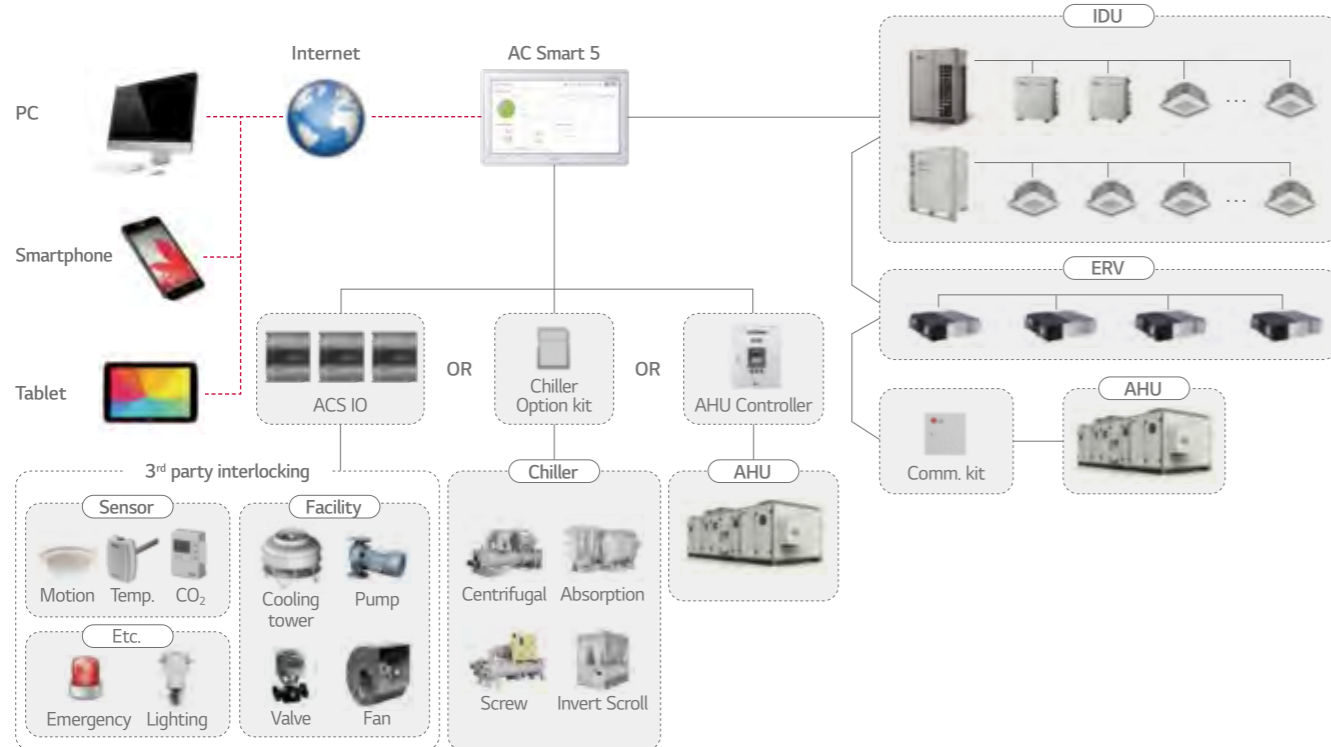

* Fix Public IP is mandatory
 * Router's Configuration of NAT is mandatory. Open port 80 & 9300

Building Management System (BMS) Integration

Without additional device, AC Smart 5 provides BACnet IP & Modbus TCP interface for BMS integration as well as its own management function.

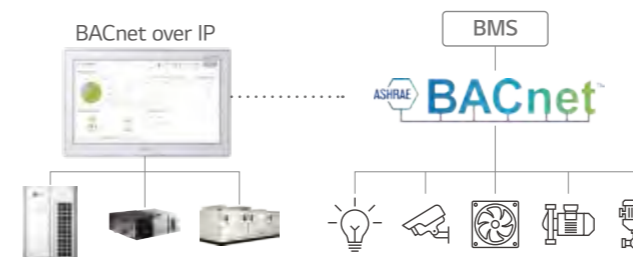

Energy Management

The energy navigation function allows the air conditioner's operational energy usage to be managed monthly, weekly and yearly. By analyzing present energy consumption and comparing with the plan, overuse of system operational costs can be prevented.

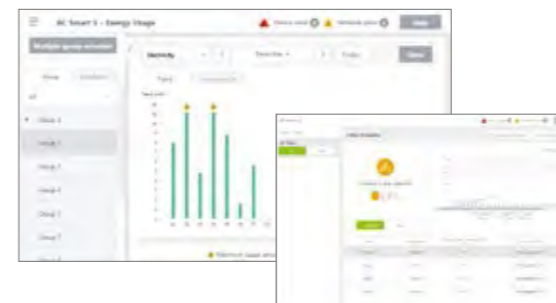

Advanced Network Accessibility

AC Smart 5 reflects the state of the art of network technology trend. IPv6 (Internet Protocol version 6), which is the most recent version of the Internet Protocol, provides accessibility to the IPv6 compatible network environment. In addition, HTML5 allows you to easily control LG HVAC system on a variety of platforms (PC, Mobile, Tablet), at any time and from any location, not just on the touch screen.

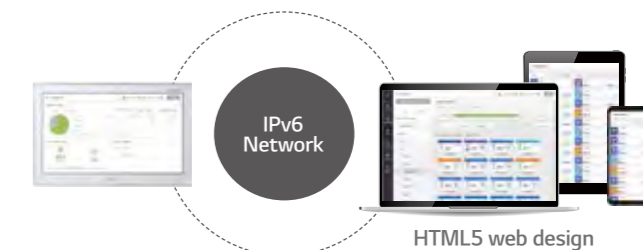

Visualized Control

Visual navigation enables controlling and monitoring the unit on floor plan view for the intuitive management.



Multi Level Group Composition

User can make frequent and multi level group to control and monitor the device easily.

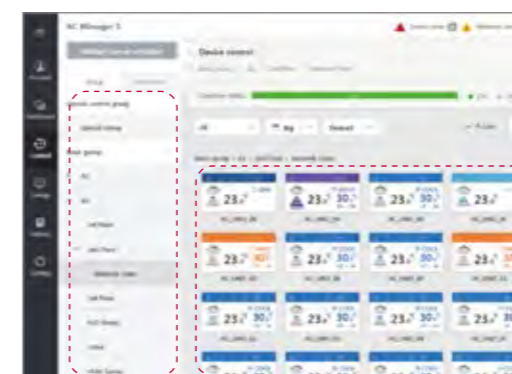

Interlocking with 3rd party equipment

AC Smart 5 can make operation scenario with 3rd party equipment by ACS IO Module. Control coverage is expanded. (Air conditioner only → Sensors, Fans, Pumps, Switches...)

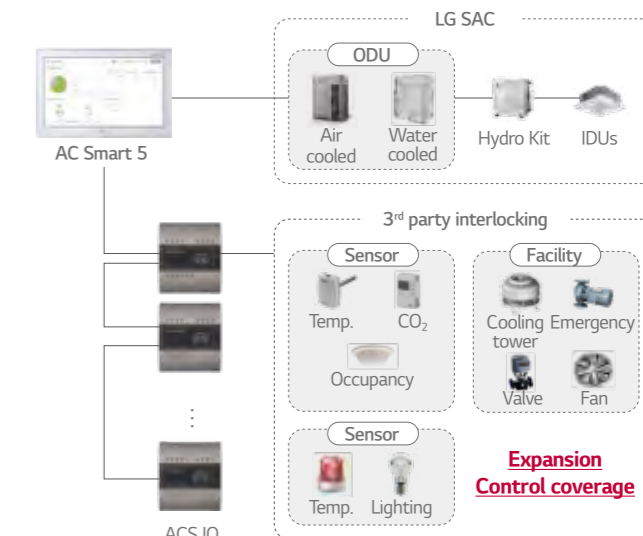

CONTROL SOLUTIONS CENTRALIZED CONTROL

ACP 5

Advanced solution for BMS integration up to 256 units via BACnet and Modbus protocol as well as its own smart management function with web server interface.



PACP5A000

Features & Benefits

- The central controller allows control of the LG HVAC system by various platforms. (PC, Smartphone, Tablet)
 - DI :10 / DO : 4
 - Max. 256 IDU control
 - BACnet IP/Modbus TCP
 - Schedule
 - Map view (Visual navigation)
 - Time limit control / Auto change over
 - Energy monitoring
 - History / Operation trend
 - Interlock with 3rd party equipment (ACS IO, ACU IO Module is needed)
 - Multi level grouping
 - Emergency stop & alarm
 - Error alarm by e-mail

Model Name	PACP5A000
Size (W x H x D, mm)	270 x 155 x 65
Interfaceable Products	MULTI V / ERV / ERV DX / HYDRO KIT / THERMA V / AHU kit / LG Chiller ¹⁾
Maximum number of units	256
Individual / Group Control	On & Off / Mode / Temperature / Fan speed
Individual Controller Lock	Temperature / Mode / Fan speed / All
Advanced Function Setting and Display ²⁾	Comfort Cooling / ODU Low Noise / ODU Defrost Mode / Comfort Level display / CO ₂ Level display (for ERV / ERV DX) / Night Time Free Cooling (for ERV / ERV DX)
Error Check	○
Schedule	Weekly / Monthly / Yearly / Exception day
Web Access	○
Emergency Stop & Alarm Display	○
Power Consumption Monitoring (with PDI)	○
Auto Changeover / Setback	○
Temperature Limit	○
Operation Time Limit	○
Visual Navigation	○
Operation Trend	○
Interlock Control	○
Virtual Group Control	○
ODU Capacity Control	○
Energy Navigation (with PDI)	○
Daylight Saving Time	○
External IO Port	DI 10 / DO 4
BMS Integration ³⁾	BACnet IP / Modbus TCP
IPv6 Support	○

※ ○ : Applied, - : Not Applied
 1) Chiller Option Kit (PCHLLN000) is required
 2) It is only available in some products
 3) For the detail point list, please refer to the installation manual

Overview

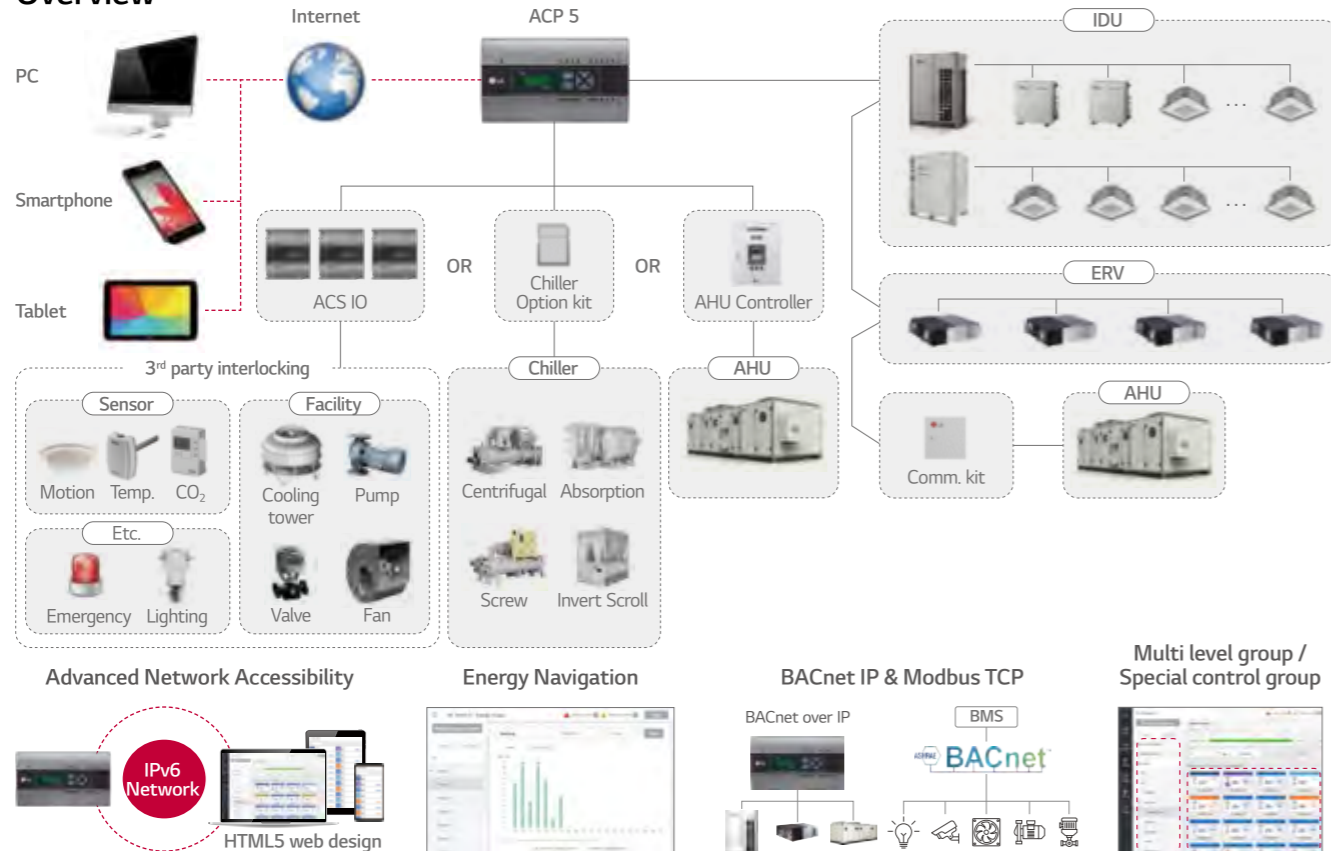

* Fix Public IP is mandatory
 * Router's Configuration of NAT is mandatory. Open port 80 & 9300

ACP LONWORKS GATEWAY

Lonworks easily link LG air conditioners and other existing building systems. By including ACP control function, the controlling continues even when error occurs with BMS.



PLNWKB000

Features & Benefits

- Connect to use Lonworks protocol and LG air conditioner protocol.
- Process ability (Max. connection) : Indoor unit 64EA, AHU Control Kit : Max. 16EA
- Self installation verification using internet (Web Server Included) - Diagnosis of communication status on LG Air-conditioner network
- It offers a variety of functions as ACP which allows the customer to efficiently control various types of equipment from the customer's own Integration.

Control	Monitoring
On / Off Command	On / Off
Operation Mode Setting	Operation Mode
Lock	Lock
Temperature	Temperature
Fan Level	Fan Level
Fan Direction Auto	Fan Direction Auto
Mode Lock	Mode Lock
Fan Level Lock	Fan Level Lock
Temperature Lock	Temperature Lock
Temperature Lower Limit	Temperature Lower Limit
Temperature Higher Limit	Temperature Higher Limit
Peak Convert Cycle	Peak Convert Cycle
Peak Setting	Peak Setting
Temperature Unit	Temperature Unit
Total Temperature Lock	-
Total On / Off	-
Total Temperature	-
-	Product Type
-	Product Address
-	Current Temperature
-	Alarm
-	Power
-	Error Code
-	Peak Current Operating Percent
-	Total Accumulate Power

※ ○ : Applied, - : Not Applied

Overview

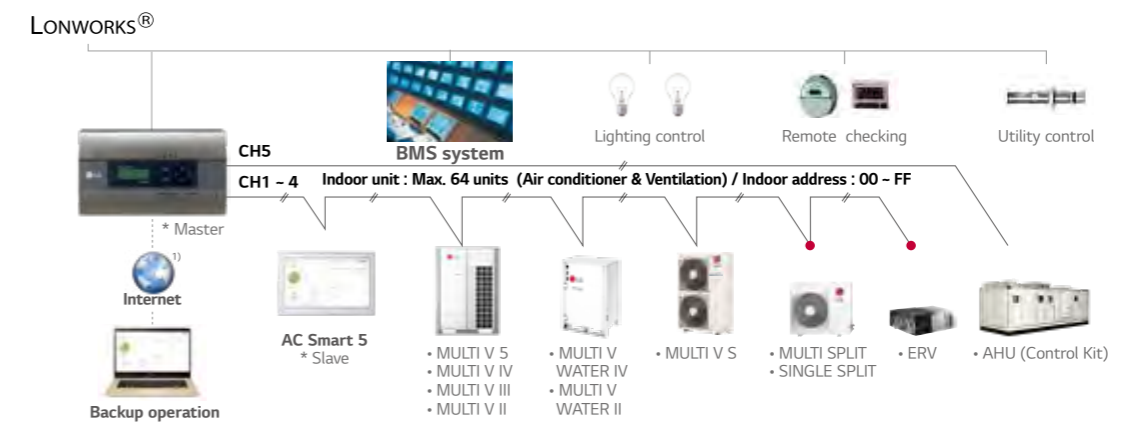

* Fix Public IP is mandatory
 * Router's Configuration of NAT is mandatory. Open port 80 & 9300
 1) Assignment of public IP address is required to access central controller through internet.

PI 485

PI 485 converts LG air conditioner's protocol to the RS485 protocol for the central controller.



PHNFP14A0

- Power : Connected with the Indoor Units
- 1 for Each Indoor Unit
- Indoor Unit (ERV)

AC MANAGER 5

Multiple ACP and AC Smart integration solution to manage multi sites up to 8,192 units as a single system.



PACM5A000

Features & Benefits

- Consol Type : No needs software installation and lock-key
- Max 8,192 IDU Control
- Schedule
- Map View (Visual Navigation)
- Time limit control / Auto change over
- Energy Monitoring / Navigation
- History / Operation Trend
- Emergency stop & alarm
- Error alarm by E-mail
- Multi Language
(Eng, Ita, Spa, Por, Rus, Fra, Ger, Tur, Pol, Chi, Kor)

Model Name	PACM5A000
Size (W x H x D, mm)	270 x 155 x 65
Interfaceable Products	MULTI V / ERV / ERV DX / HYDRO KIT / THERMA V / AHU kit / LG Chiller ¹⁾
Maximum number of units	8,192 (supports 32 ACP 5 or AC Smart 5)
Individual / Group Control	On & Off / Mode / Temperature / Fan speed
Individual Controller Lock	Temperature / Mode / Fan speed / All
Error Check	○
Schedule	Weekly / Monthly / Yearly / Exception day
Web Access	○
Emergency Alarm Display	○
Power Consumption Monitoring (with PDI)	○
Auto Changeover / Setback	○
Temperature Limit	○
Operation Time Limit	○
Visual Navigation	○
Operation Trend	○
Interlock Control	○
Virtual Group Control	○
ODU Capacity Control	○
Energy Navigation (with PDI)	○

※ ○ : Applied, - : Not Applied
 1) Chiller Option Kit (PCHLLN000) is required
 Note : AC Manager 5 requires ACP 5 or AC Smart 5

Overview

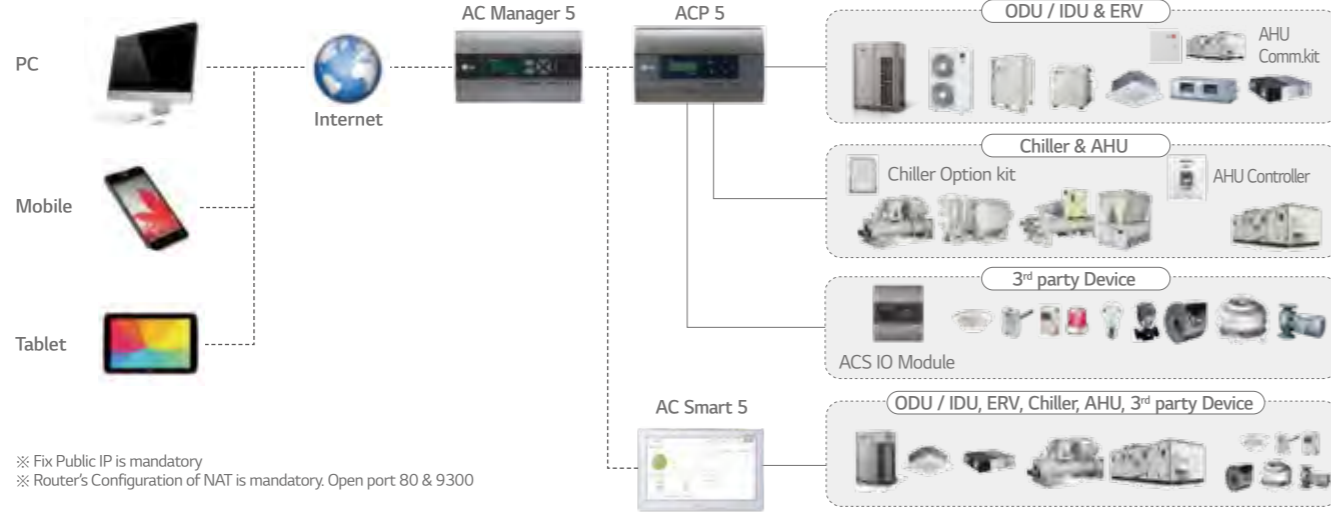

※ Fix Public IP is mandatory
 ※ Router's Configuration of NAT is mandatory, Open port 80 & 9300

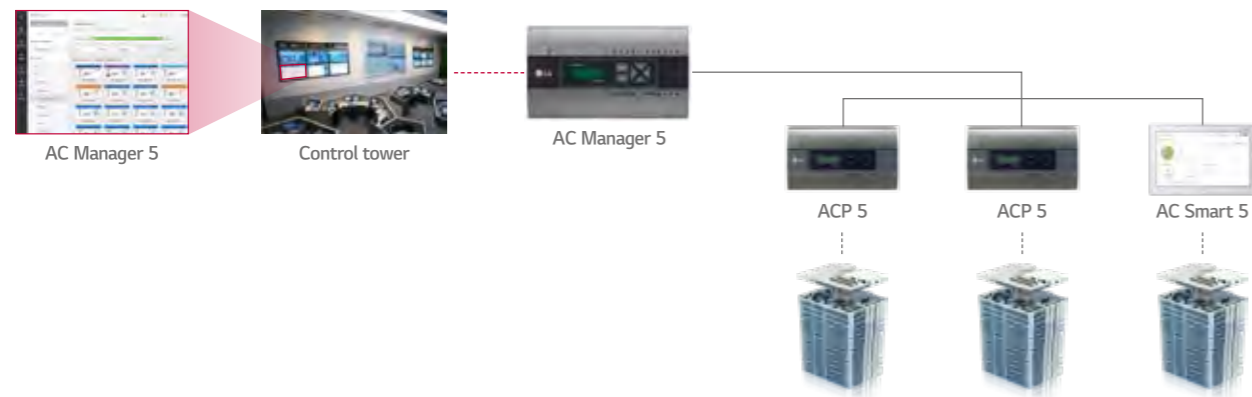

Stand-alone

Integrated with S/W program and Hardware platform, it is convenient to install since users no longer need to install program with lock-key on PC.



Up to 8,192 Connections for Indoor Units

Administrators can easily and conveniently manage a variety of LG HVAC equipment. Also, it is available to manage many buildings or areas at one place via AC Manager 5.

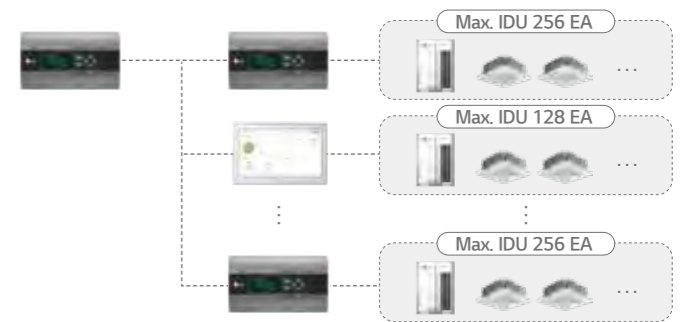

Advanced Network Accessibility & User Friendly GUI (Reddot award)

As an advanced central controller, AC Manager 5 offers flexible interface for each user by assessing the device screen and automatically customizing the layout to provide the most optimized interface.



Energy Navigation & Energy Usage Trend

Energy navigation is the function to set the target usage amount to limit the monthly power consumption and to control so that the total accumulated power consumption does not exceed the target usage amount. It performs total of 7 control levels with the estimated / actual usage amount exceeding ratio compared to the monthly target usage amount. For the control method, there are indoor unit operation ratio, outdoor unit capacity control, and indoor unit operation control.

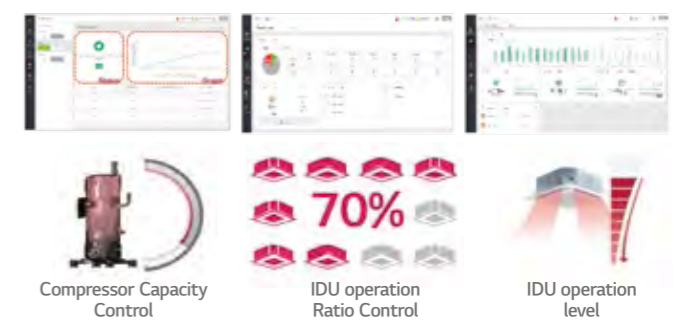

Peak Control

This function can reduce electricity use. There are two kinds of control logic. Energy saving effect by indoor unit operation rate control. Load management effect by outdoor unit capacity control.

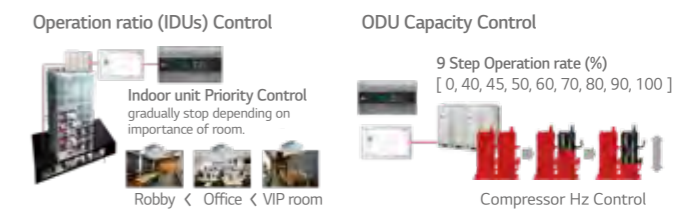

Multi Level Group Composition

User can make frequent and multi level group to control and monitor the device easily.

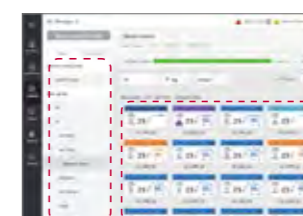

CONTROL SOLUTIONS CENTRALIZED CONTROL

MODBUS RTU GATEWAY

Providing Modbus RTU connection between LG Air conditioners and BMS.



PMBUS00A

Features & Benefits

- Function
 - MODBUS RTU communication with MODBUS master controller
 - MODBUS RTU slave (RS485) / 9,600 bps
 - Applicable for MULTI V 5, MULTI V S, ERV, THERMA V
- Size (W x H x D) : 53.6 x 89.7 x 60.7
- Max. 16 IDUs with single module / Max. 64 IDUs with 4 modules
- Power : DC 12V

Modbus Gateway Memory Map

Baud Rate : 9,600 bps, Stop Bit : 1 stop bit, Parity : None Parity, Byte size : 8 bits

Coil Register (0 x 01)

No.	Data Bit			Function	Register
	Air Conditioner	ERV / DX ERV	HydroKit & THERMA V		
1	Operate (On / Off)	Operate (On / Off)	Operate (On / Off)	0 : Stop / 1 : Run	Register = N X 16 + ① (N = Indoor Unit Central Address)
2	Auto Swing	Aircon Operate (On / Off)	Hot Water Mode (On / Off)	0 : Disable / 1 : Enable	
3	Filter Alarm Release	Filter Alarm Release ¹⁾	Reserved	0 : Normal / 1 : Alarm Release	
4	Lock Remote Controller	Lock Remote Controller	Lock Remote Controller	0 : UnLock / 1 : Lock	
5	Lock Operate Mode	Lock Operate Mode ¹⁾	Reserved	0 : UnLock / 1 : Lock	
6	Lock Fan Speed	Lock Fan Speed ¹⁾	Reserved	0 : UnLock / 1 : Lock	
7	Lock Target Temp.	Lock Target Temp. ¹⁾	Reserved	0 : UnLock / 1 : Lock	
8	Lock IDU Address	Lock IDU Address ¹⁾	Reserved	0 : UnLock / 1 : Lock	
9	Reserved	Quick Ventilate	Reserved	0 : Disable / 1 : Enable	
10	Reserved	EnergySave	Reserved	0 : Disable / 1 : Enable	

Note 1) : This register value is applied 'DX Ventilator' ONLY.

Discrete Register (0 x 02)

No.	Data Bit			Function	Register
	Air Conditioner	ERV / DX ERV	HydroKit & THERMA V		
1	Connected IDU	Connected IDU	Connected IDU	0 : Disconnected / 1 : Connected	Register = N X 16 + ① (N = Indoor Unit Central Address)
2	Alarm	Alarm	Alarm	0 : Normal / 1 : Alarm	
3	Filter Alarm	Filter Alarm ¹⁾	Hot Water Only ²⁾	0 : Normal / 1 : Alarm Hydrokit - 0 : Normal / 1 : Hot Water Only	
4	Reserved	Reserved	Target Temp Select	0 : Air / 1 : Water	
5	Reserved	Reserved	Error Division ²⁾	0 : CH type error / 1 : BC type error	

Note 1) : This register value is applied 'DX Ventilator' ONLY. Note 2) : This register value is applied 'Hydrokit' ONLY.

MODBUS RTU GATEWAY

Holding Register (0 x 03)

No.	Data Bit			Function	Register
	Air Conditioner	ERV / DX ERV	HYDROKIT & THERMA V		
1	Operate Mode	Operate Mode	Connected IDU	0 : Cooling, 1 : Dehumidifying, 2 : Fan, 3 : Auto, 4 : Heating Hydrokit (Middle Temp. DHW) / AWHP - 0 : Cooling, 3 : Auto, 4 : Heating Hydrokit(High Temp. DHW)	Register = N X 20 + ① (N = Indoor Unit Central Address)
2	Fan Speed	Fan Speed	Target Temp. DHW ²⁾	1 : Low, 2 : Mid, 3 : High, 4 : Auto	
3	Target Temp.	Target Temp. ¹⁾	Target Temp. ²⁾	16.0 ~ 30.0 [°C] x 10	
4	Target Temp. Limit (Upper)	Target Temp. Limit ¹⁾ (Upper)	Reserved	16.0 ~ 30.0 [°C] x 10	
5	Target Temp. Limit (Lower)	Target Temp. Limit ¹⁾ (Lower)	Reserved	16.0 ~ 30.0 [°C] x 10	
6	Reserved	Vent. Operate Mode	Reserved	0 : HEX, 1 : Auto, 2 : Normal	

Note 1) : This register value is applied 'DX Ventilator' ONLY.
2) : This value range can be between 0 - 127 [°C]. And it would be limited by upper & lower value according to the setting of remote controller.

Input Register (0 x 04)

No.	Data Bit			Function	Register
	Air Conditioner	ERV / DX ERV	HYDROKIT & THERMA V		
1	Error Code	Error Code	Error Code	0 ~ 255 ※ Please refer to the product error table.	Register = N X 20 + ① (N = Indoor Unit Central Address)
2	Room Temp.	RA Temp.	Room Temp.	-99.0 ~ 99.0 [°C] x 10	
3	Pipe In Temp.	OA Temp. ¹⁾	Water Inlet Temp.	-99.0 ~ 99.0 [°C] x 10	
4	Pipe Out Temp.	SA Temp. ¹⁾	Water Outlet Temp.	-99.0 ~ 99.0 [°C] x 10	
5	Reserved	Pipe In Temp. ¹⁾	Sanitary Tank Temp.	-99.0 ~ 99.0 [°C] x 10	
6	Reserved	Pipe Out Temp. ¹⁾	Solar Temp. ²⁾	-99.0 ~ 99.0 [°C] x 10	

Note 1) : This register value is applied 'DX Ventilator' ONLY.
2) : This register value is applied 'AWHP' ONLY.

Installation Scene

- Single module
Max. 16 indoor units with a single module

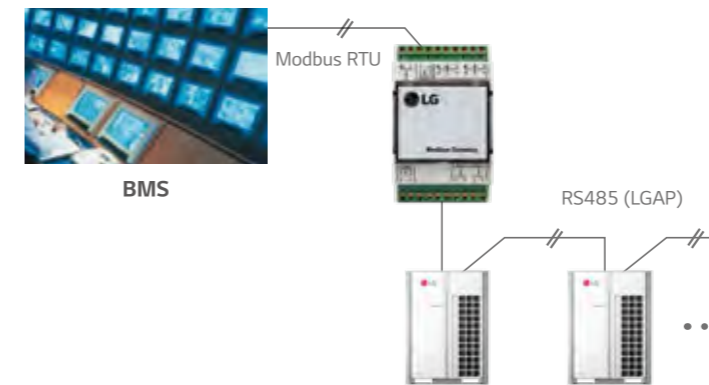

- Multiple module
Max. 64 indoor units with 4 modules in one Modbus communication line

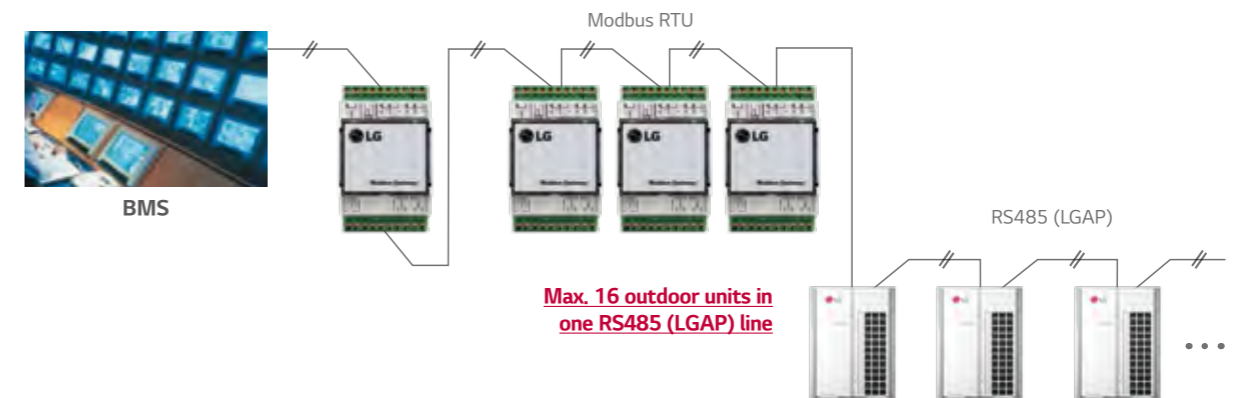

INTEGRATION DEVICE



PDI (POWER DISTRIBUTION INDICATOR)

PDI shows distributed power consumption of up to 128 indoor units.



PQNUD1S40 (Premium, 8 port)
PPWRDB000 (Standard, 2 port)

Model Name	PQNUD1S40	PPWRDB000
Size (W x H x D, mm)	270 x 155 x 65	
Interfaceable Products	Air conditioner, ERV DX	
Maximum Number of Power Meters	EHP : 8 Watt meter GHP : 4 Watt meter / 4 Gas meter	EHP : 2 Watt meter GHP : 1 Watt meter / 1 Gas meter
Maximum Number of Indoor Units	MULTI V : 128	
Data Backup When Power Outage	○	
Power Input	PDI : AC 24V, Transformer : AC 220V	

※ ○ : Applied, - : Not Applied

Features & Benefits

- Enables total and indoor power consumption monitoring
- With LG central control connectivity, energy monitoring, energy savings operations and target usage setting functions are enabled
- Enables gas consumption and electricity distribution

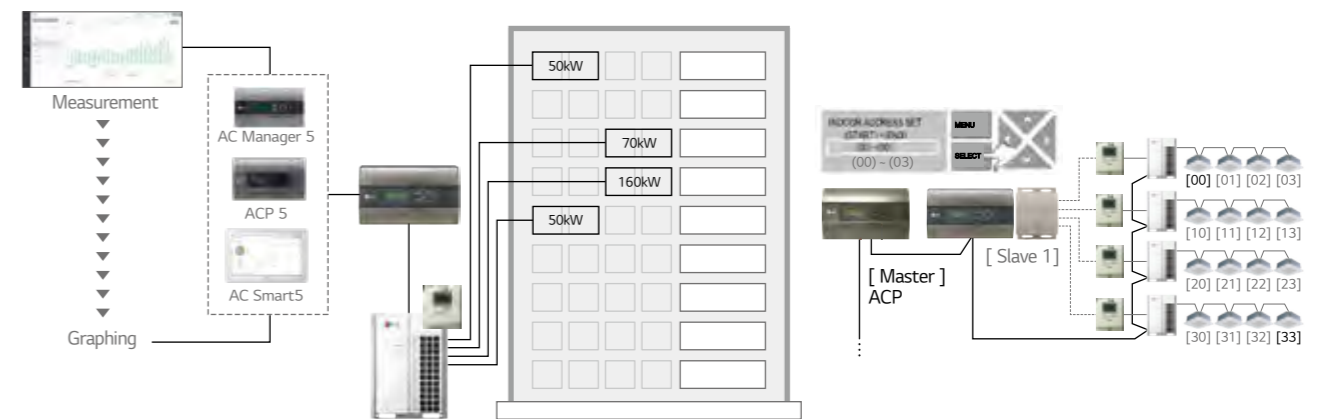
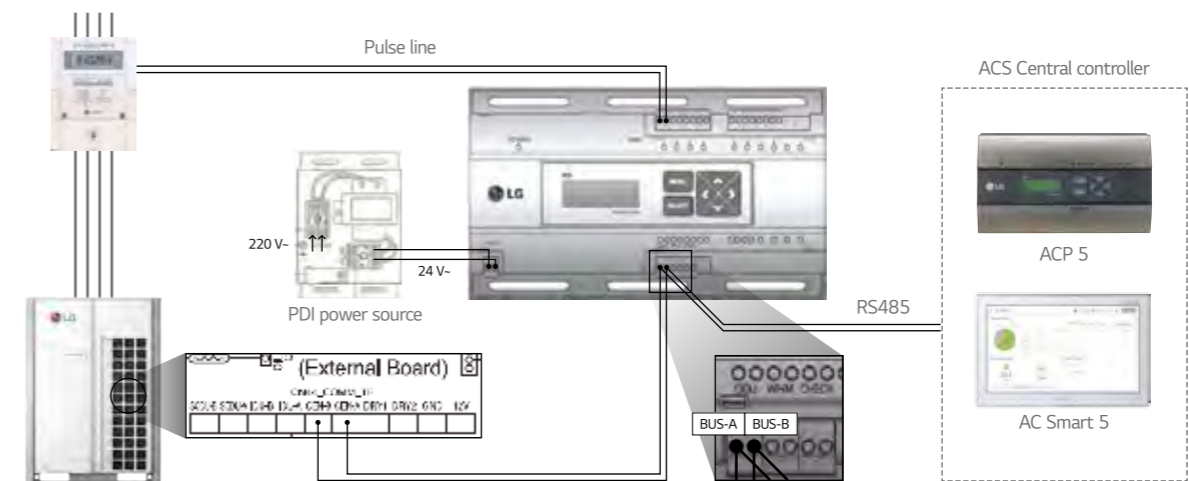

Note : 1. Power cable and type could be different from this scene depending on the Outdoor unit's specification.
 2. Measured power consumption could be different between PDI and Watt meter.
 3. Applicable Central Controller : ACP 5, ACP Lonworks, AC Smart 5, AC Ez Touch
 (Combination : we recommend to connect separated watt meter for Outdoor units to have correct power distribution value)

ACS IO MODULE

This module can be connected with ACP 5 or AC Smart 5 controller if additional I/O points such as DI/DO and AI/AO for 3rd party devices control and monitoring are needed.



PEXPMB000

Model Name	PEXPMB000		
Linkable Products	PACS4B000 PACP4B000 PACS5A000 PACP5A000		
Communication	RS-485	1 ch.	
I/O	Digital Input	3 port	
	Digital Output	3 port	
	Universal Input ¹⁾	4 port	
	Analog Output	4 port	
Analog Input	Value Spec	Min.	Max.
	NTC 10k	0.68kΩ	1.77kΩ
	PT 1000	803kΩ	1,573kΩ
	Ni 1000	871.7kΩ	1,675.2kΩ
	DC (Voltage)	0V	10V
Analog Output	DC (Current)	0mA	20mA
	-	0V	10V
Digital Input	Binary Input (Non Voltage)	-	-
Digital Output	Normal open	-	30VAC / 30VDC, 2A

※ ○ : Applied, - : Not Applied
1) The type of UI (Universal Input) is selectable among Digital Input and Analog Input

Features & Benefits

- Interlocking with 3rd party equipment LG Central controller can make operation scenario with 3rd party equipment by ACS IO Module.
- Control coverage is expanded. (Air conditioner only → Sensors, Fans, Pumps, Switches...)

Key Application

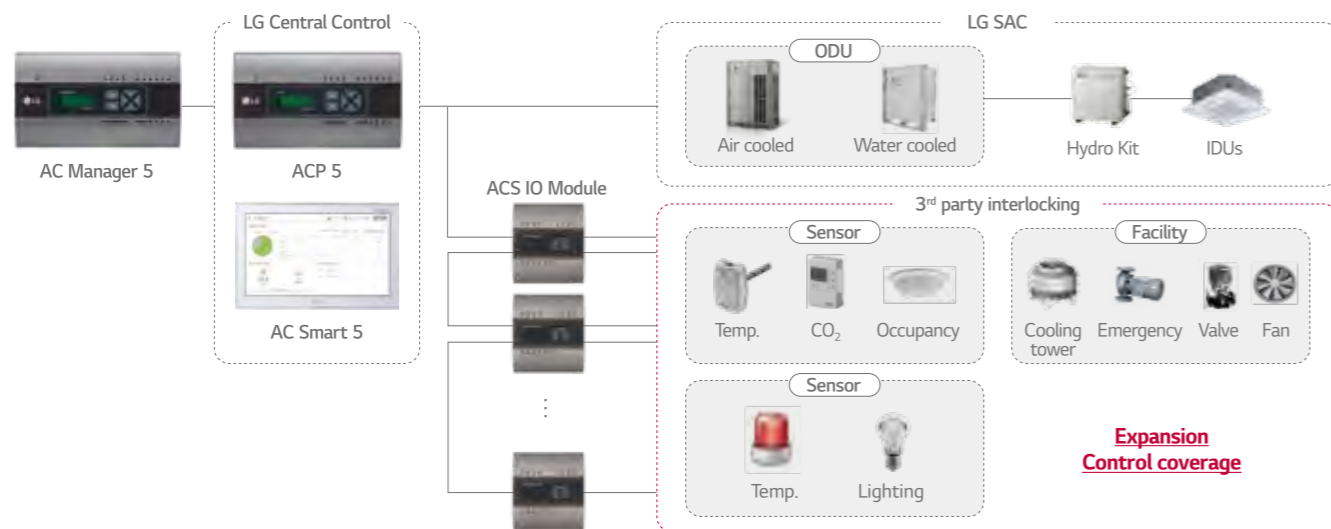

* DI : Digital Input, DO : Digital Output, UI : Universal Input, AO : Analog Output / Please contact our regional office to have connectable relay specification for analog output

ACU IO MODULE

This module can be connected with ACP 5 or AC Smart 5 controller if additional I/O points such as UIO / UI / UO for 3rd party devices control and monitoring are needed.

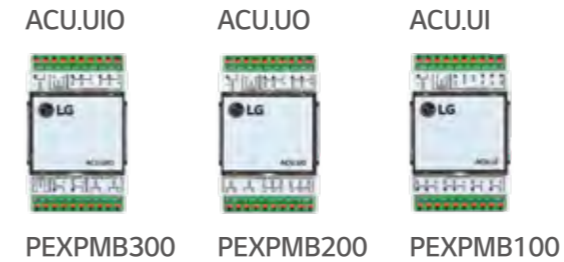

Module Name	PEXPMB300	PEXPMB200	PEXPMB100	
Linkable Products	PACS5A000, PACP5A000			
Communication RS-485	2 ch. ¹⁾	1 ch.	1 ch.	
Digital Input	-	-	3 port	
Digital Output	2 port	6 port	-	
Universal Input ²⁾	4 port	-	6 port	
Analog Output	2 port	4 port	-	
Value Spec	Min.	Max.		
	Analog Input DC (Voltage)	0V	10V	
Analog Output	DC (Voltage)	0V	10V	
Digital Input	Binary Input (Non Voltage)	-	-	
Digital Output	Normal Open	-	30VDC, 1A	

※ ○ : Applied, - : Not Applied
1) 1ch is reserved for internal communication
2) The type of UI (Universal Input) is selectable among Digital Input and Analog Input

Features & Benefits

- Interlocking with 3rd party equipment LG Central controller can make operation scenario with 3rd party equipment by ACU IO Module.
- Applicable devices are expanded. (Air conditioner only → Sensors, Fans, Pumps, Switches...)

CHILLER OPTION KIT

LG central controller 5 series with Chiller Option Kit can provide LG chiller remote control and cycle monitoring.



PCHLLN000

Model Name	PCHLLN000
Monitoring Points	Evaporator status / Compressor status (Scroll, Screw, Centrifugal chiller only) / Condenser status / Generator status (Abs. chiller only)
On / Off	○
Target Temp. setting	○
Mode Change	Scroll chiller only
Schedule	○
Interfaceable Products	Scroll, Screw, Centrifugal, Absorption (LG Only)

※ ○ : Applied, - : Not Applied

Cycle Display Example



Installation Scene

- Chiller Option Kit installation of LG HVAC Solution product should be conducted by a specialized installation service engineer.
- Chiller Option Kit installation can be achieved with a SD Card.
- The SD Card can install Chiller Option Kit in one LG HVAC Solution product.

Insert the SD Card in the LG HVAC Solution product. If a backup SD Card is inserted, replace it with a Chiller Option Kit SD Card.



DRY CONTACT

Connection between an indoor unit and external devices to control various functions.

Model Name	PDRYCB000	PDRYCB400	PDRYCB300	PDRYCB320*	PDRYCB500
Case	○	○	○	○	○
Input Port	1	2	8	8	-
Universal Input port	-	-	-	1	-
Comm. Protocol	-	-	-	-	Modbus RTU
Power	AC 220V		Connect to Indoor unit PCB (CN_CC)		
Aircon					
On / Off	○	○	○	○	○
Oper Mode	-	○	○	○	○
Set Temp.	-	(Select & Fix)	(Select & Fix)	(Select & Fix)	○
Fan Speed	-	-	○	○	○
Thermo-Off	-	(Select & Fix)	○	○	-
Energy Saving	-	(Select & Fix)	-	-	-
Lock/Unlock	-	(Select & Fix)	-	-	-
Control					
AWHP					
On / Off	○	-	○	○	-
DHW On / Off	-	-	○	○	-
Thermo-Off	-	-	○	○	-
Oper Mode	-	-	○	○	-
Silent Mode	-	-	○	○	-
Emergency Mode	-	-	○	○	-
Vent					
On / Off	○	-	-	-	○
Oper Mode	-	-	-	-	○
Aircon Mode	-	-	-	-	○
Additional Mode	-	-	-	-	○
Fan Speed	-	-	-	-	○
Output					
Operation Status	○	○	○	○	○
Error	○	○	○	○	○
Room Temp.	-	-	-	-	○

※ ○ : Applied, - : Not Applied

*Available from April 2020

Note : 1. Compatibility of PDRYCB300 / PDRYCB320

- Can use with all types of aircon indoor units after 2010 (Cassette, Ducted, Convertible, Applied PAC, Wall mounted, Console)
- Can use with new single package AK-W model after 2020. 1Q (The previous version Single package is not compatible)
- AWHP : 3 series split and monobloc models

2. Compatibility of PDRYCB400

- Can use with all types of aircon indoor units after 2010 (Cassette, Ducted, Convertible, Applied PAC, Wall mounted, Console)
- Can use with new single package AK-W model after 2020. 1Q (The previous version Single package is not compatible)
- Can not use with AWHP, Hydrokit models

3. (Select & Fix) : This function is preset by rotary switch.

PDRYCB000

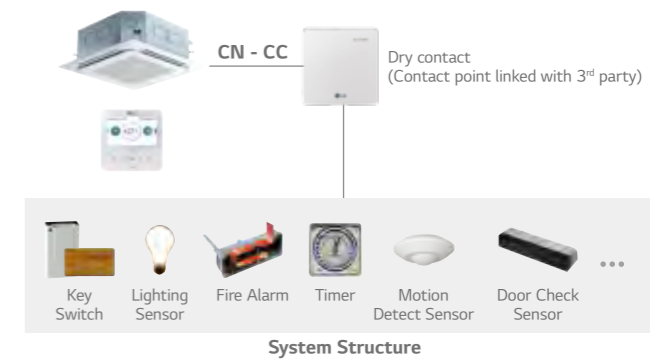

PDRYCB400

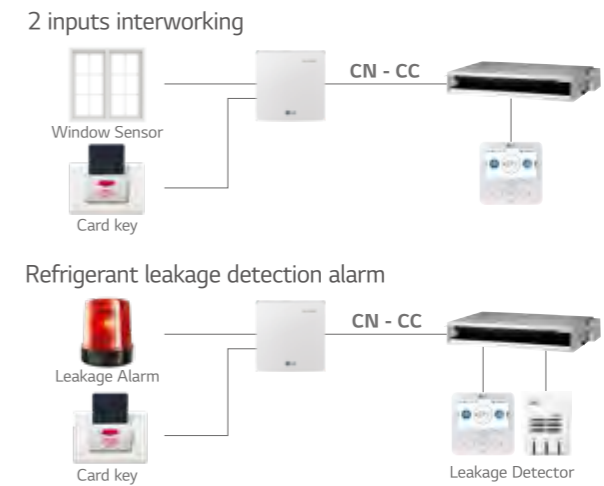

PDRYCB300 / PDRYCB320

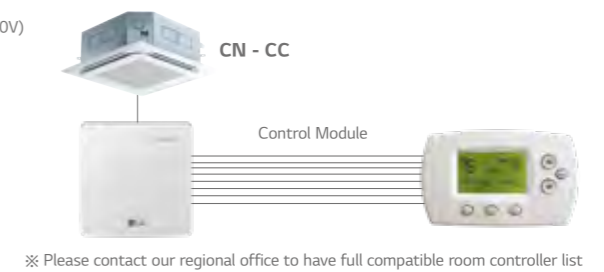

PDRYCB500

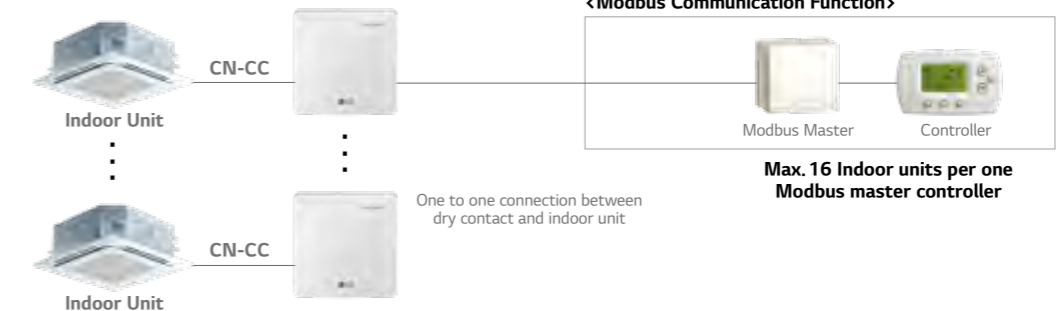

※ Please contact our regional office to check the compatibility with 3rd party room controller.

GROUP CONTROL WIRE

Cables used to connect a wired remote controller up to 16 indoor units.



PZCWRCG3

Model Name	PZCWRCG3
Y-type Cable	0.25m Length
Long Cable	9.6m Length

Installation Scene

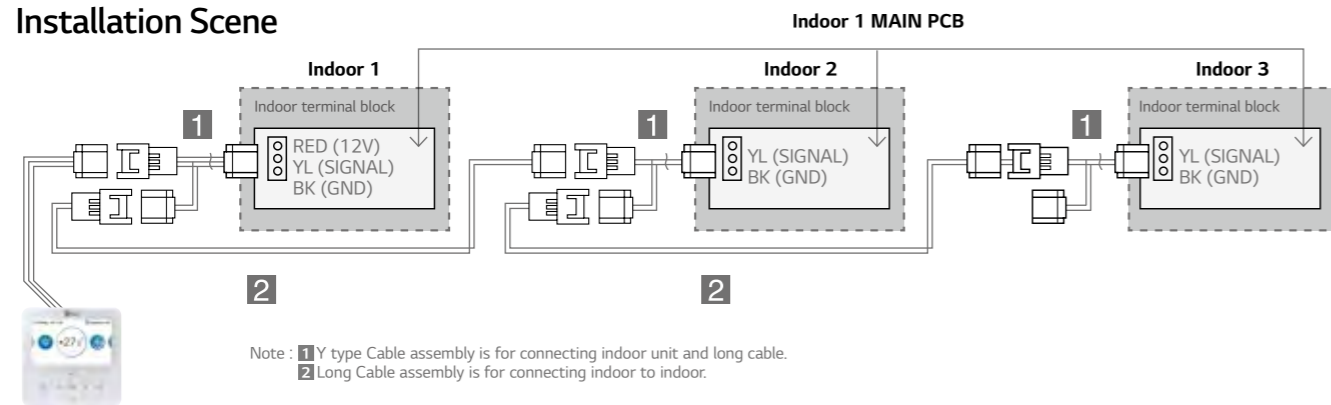

REMOTE TEMPERATURE SENSOR

Sensor for detecting the room temperature.



PQRSTA0

Features & Benefits

- It detects the exact room temperature instead of indoor unit's air temperature sensor.
- Applied to Ceiling Mounted Cassette, Ceiling Concealed Duct, THERMA V and HYDRO KIT.
- Extension cable (15m) is included.

Installation Scene

1. Wire to the control box in the indoor unit by removing the existing thermistor and connect the extension cable its place.
2. Cut the extension cable to the appropriate length and connect the screw terminal of the remote sensor.

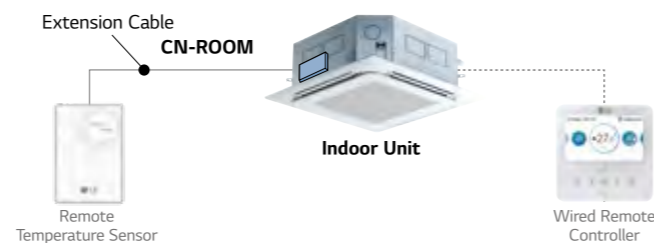

LOW PROFILE REMOTE TEMPERATURE BUTTON SENSOR

Allows for easy and discreet installation as well as connection to an indoor unit.



ZRTBS01

Model Name	ZRTBS01	
Operation Range	-40 °C to 85 °C (0 to 100%RH, Non-condensing)	
Sensing Element	Thermistor	
Sensing Element Accuracy	0.2 °C (0 to 70 °C)	
Wire Leads	Material	Etched Teflon
	Length	15m
	Thickness	0.33mm ²
Mounting	10mm hole, push in plastic sheath with peel off tape strip	
Enclosure Material Ratings	Plastic, NEMA 1, UL94	

Features & Benefits

- Ideal for locations where aesthetics are as important as the temperature measurement.
- Inconspicuous wall sensor that mounts easily by pushing through a 10mm hole and secured with a peel off tape strip.
- Small flush sensor mounting.
- Accurate direct air measurement.
- Paintable with latex or oil base.

Key Application

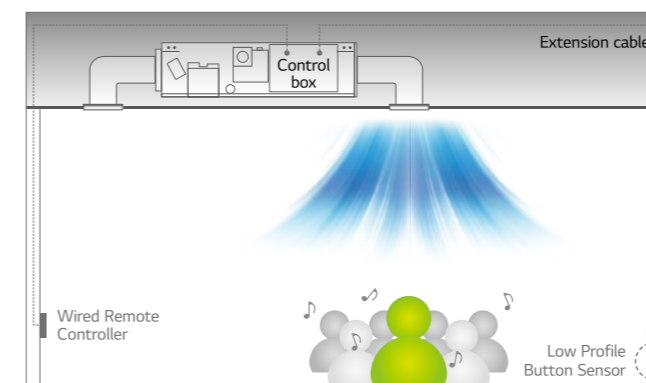

Models Applied

- LG indoor units excluding Wall-Mounted Type

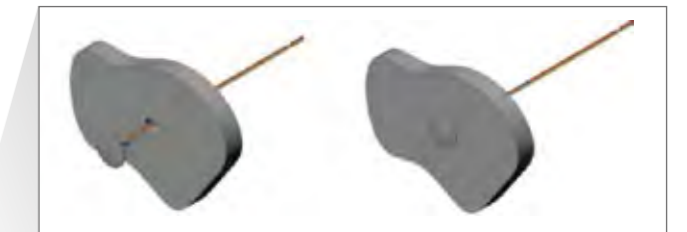

Installation Scene

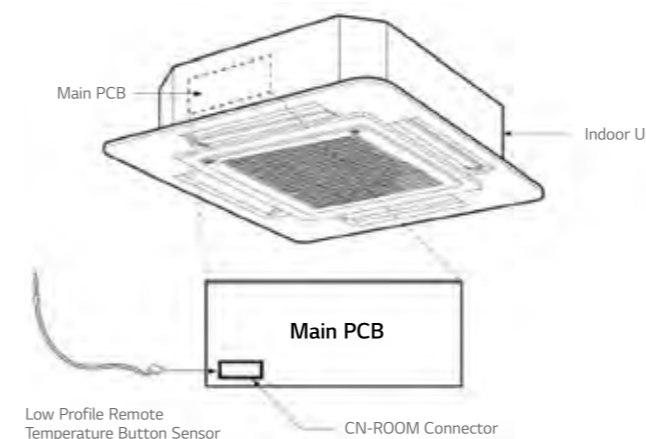

Drawing

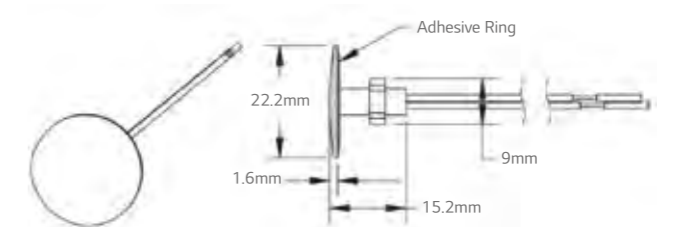

ZONE CONTROLLER

Controls air conditioning in up to 4 zones by external thermostat.



ABZCA

Features & Benefits

- Controls different zones (up to 4 zones) by external thermostat (AC 24V)
- Maintain proper air volume of each zone
- Auto variation of dampers
- Auto control of fan speed and On / Off operation

Models Applied

- Ceiling Concealed Duct (Refer to Product Data Book for applicable models)

Wiring Diagram

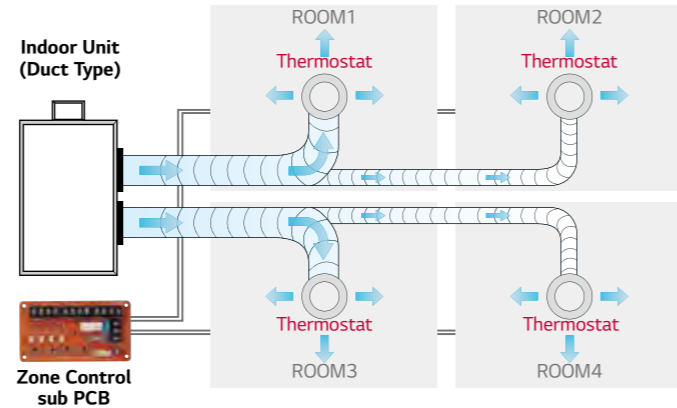
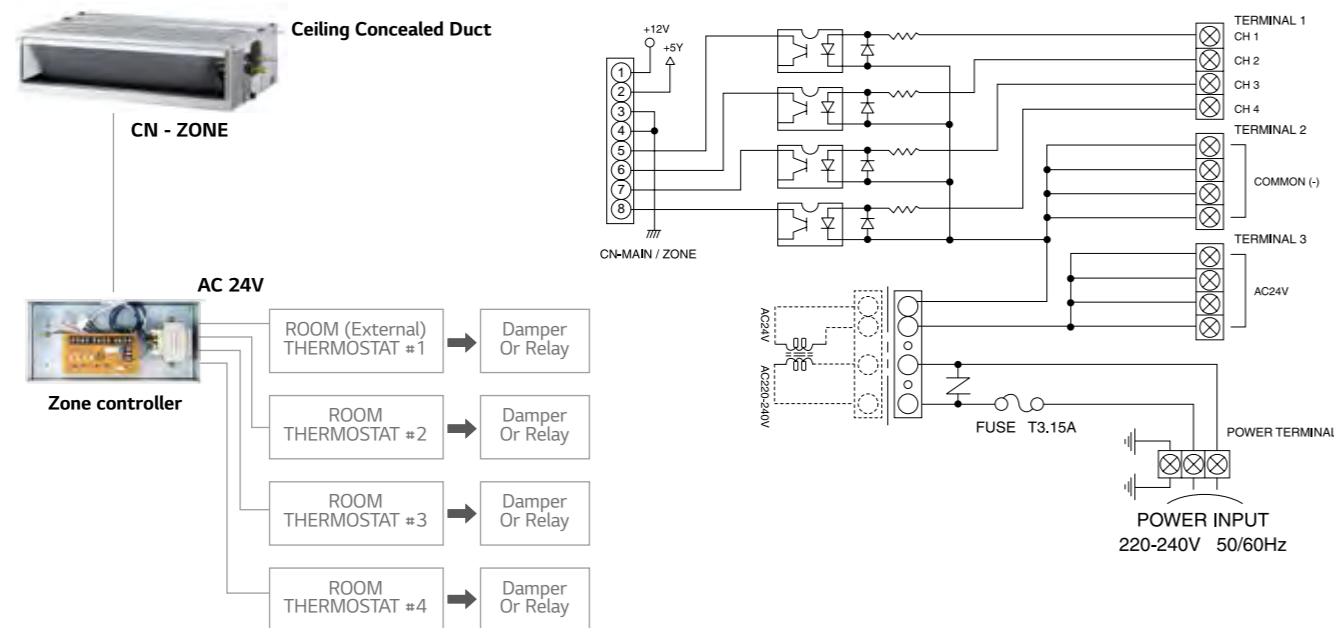

IO MODULE

Interface module between system air conditioner's outdoor unit and external device.



PVDSMN000

Features

Function

- Demand control
- Low noise operation
- Output outdoor or indoor unit operation status
- Output error status

Description

- IO Module is communication interface module for connection between MULTI V 5 and external IO (Input / Output Module) devices.

Models Applied

- MULTI V 5
- MULTI V WATER IV
- MULTI V S*

Note : IO Module is not compatible for Multi V III and Multi V S R32

Part Description

- 1) Digital Input Part (DI : Dry Contact Input)
 - Demand control by contact input (3 Step)
 - Low Noise Operation input
 - Priority Setting input : Setting the priority of demand control command (Capacity control for external signal from DDC vs Peak control by LG Central controller)
 - Open : External signal has priority to central controller (Default)
 - Close : Central controller has priority to external signal
- 2) Analog Input Part (AI : DC 0 ~ 10V)
 - Demand control by analog input (10 Step)
- 3) Digital Output Part (DO : AC 250V, Max. 1A)
 - Error status relay output
 - Operation status relay output
 - Valve control

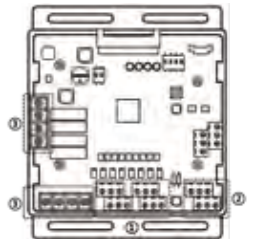

Key Application

Demand Control

Provides variable setting for demand control according to input method to reduce power consumption. This function supports 2 types of input signal : AI (0 ~ 10V, 10 Step) and contact signal (3 Step).

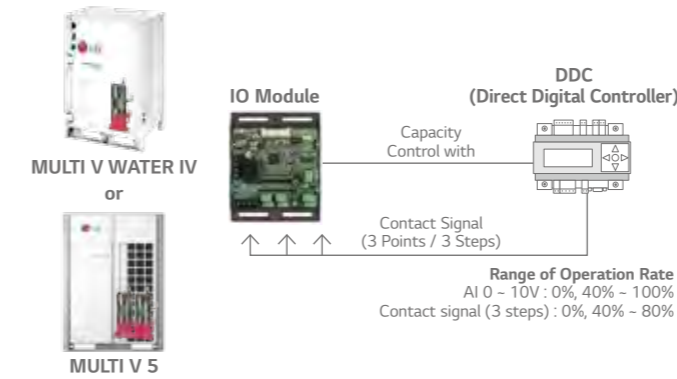

Low Noise Operation

To reduce noise level, control outdoor unit's fan speed by dry contact input.

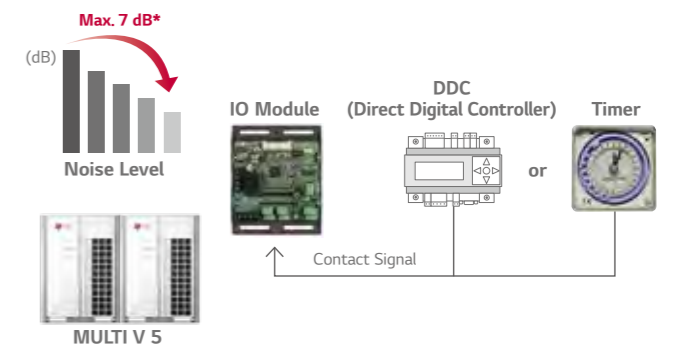

※ 8 HP (22.4kW) model, Sound power level can be changed by outdoor unit operation status and low noise operation input signal.

Refrigerant Leakage detection with Pump-down

For safety, IO module close refrigerant valve when Pump-down operation.

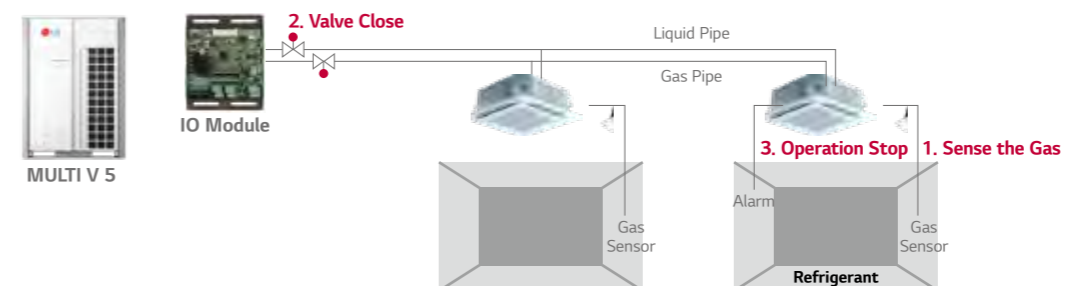

WATER COMMUNICATION MODULE NEW

This module is intended to connect 3rd party plate heat exchanger to LG outdoor unit with the ability to control water temperature from 3rd party DDC or LG remote controller.



PAHCMW000

Contents	Connection Port	Function
RS485	CH1 (A+/B-)	Module Comm. Port Communication Port Modbus Outdoor
	CH2 (A+/B-)	IDU Comm. Port Communication with MULTI V Outdoor
UNIVERSAL INPUT (Cooling/ Heating Setting)	UI1	Flow Switch Flow Switch Input by 3 rd party
	UI2	0 ~ 10V Set Temp Target Temp. Setting
	UI3	Cooling Thermostat Signal Thermostat Cooling Signal
	UI4	Heating Thermostat Signal Thermostat Heating Signal
UNIVERSAL INPUT (DHW Only)	UI1	Flow Switch Flow Switch Input by 3 rd party
	UI2	0-10V Set Temp Target Temp. Setting
	UI3	DHW Temperature Transmitter 0 ~ 10V Measured Water Temp Input by 3 rd party 0 ~ 10 V sensor
	UI4	DHW Thermostat Signal DHW Heating Signal
NTC	RI1	Water Inlet Sensor PHEX Water Inlet Sensor
	RI2	Water Outlet Sensor PHEX Water Outlet Sensor
REMO	+12V/SIG/GND LG Remote Controller	-
SINGLE	Reserved	-
DIGITAL OUTPUT	DO1	Defrost / Mode Output for defrost signal and/or cool mode
	DO2	Pump Output signal for pump on/off
	DO3	Bypass Output signal for PHEX Bypass Valve
NTC	RI3	Thermistor Pipe In PHEX Ref Inlet Pipe Sensor
	RI4	Thermistor Pipe Out PHEX Ref Outlet Pipe Sensor
EEV	+12V/1/2/3/4 Expansion Valve	EEV Control

Features & Benefits

Interlocking with 3rd parties can make various solution with LG MULTI V outdoor unit.

Overview

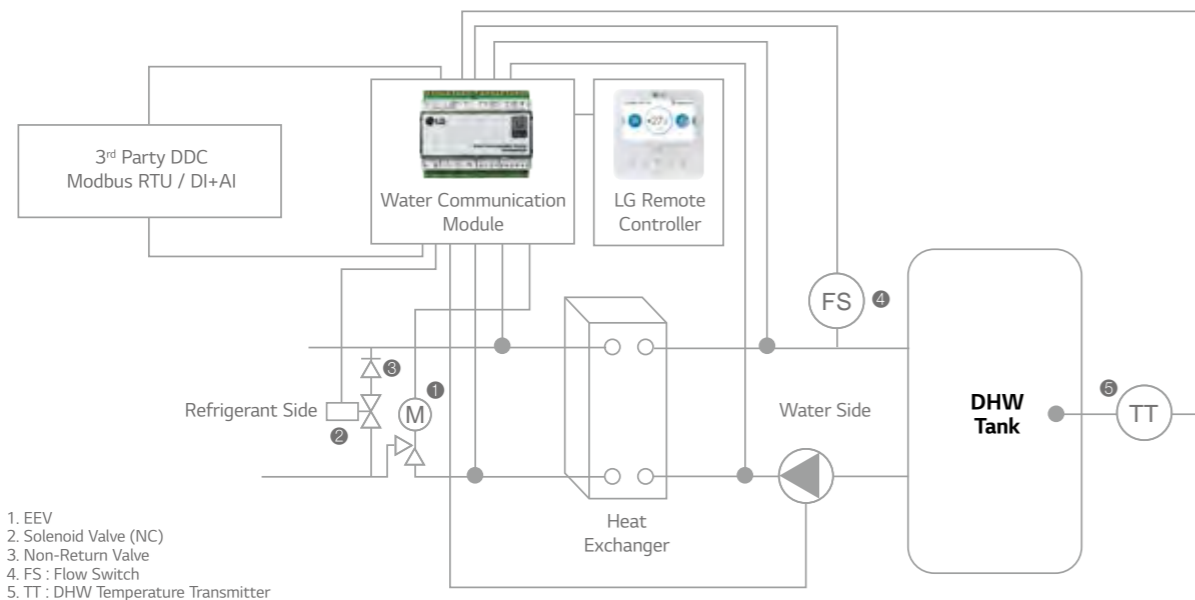

- 1. EEV
- 2. Solenoid Valve (NC)
- 3. Non-Return Valve
- 4. FS : Flow Switch
- 5. TT : DHW Temperature Transmitter

• 3rd party solenoid, non-return valve, heat exchanger, flow switch and DHW temperature transmitter (Optional) must be purchased separately (Field supplied items)

Compatibility & Accessory

EEV (LG MODEL)

Model	Capacity (kW)		PAHCMW000
	Min	Max	
PAEEVC000	3.6	28	HP/HR
PRLK048A0	3.6	28	HP/HR
PRLK096A0	28.1	56	HP

Note: Water communication module can accept plate heat exchangers from 3, 6 to 112 kW for combination with MULTI V Outdoor units.

LG Controllers

Controller	Individual Controller	Centralized Controller		Dry Contact
	Standard III	AC EZ touch	AC smart 5	
	PREMTW101	PACEZA000	PACS5A000	PDRYCB000

Specification for Field supply item

- The 3rd party can select the for best usable version

Solenoid valve for Bypass

Capacity (kW)		EEV type	System	Kv Value of solenoid and Non-Return Valve	Pipe size
Min	Max				
3.6	28	PAEEVC000 PRLK048A0	HP/HR	0.95	3/8" / 9.52mm
28	56	PRLK096A0	HP	1.9	1/2" / 12.7mm

Flow switch

- The nominal flow and cut of flow can be calculated using the values below.

Controller	Nominal Flow	Flow switch Cut off
L/min*kW	3.29	1.23

* Example : ODU nominal Cooling Capacity 28 kW
 $28 \times 3.29 = 92.12$ L/min nominal flow
 $28 \times 1.23 = 34.44$ L/min flow switch cut off

WATER COMMUNICATION MODULE APPLICATION

Installation scene with Contact connection

Contact signal + DHW Only Setting

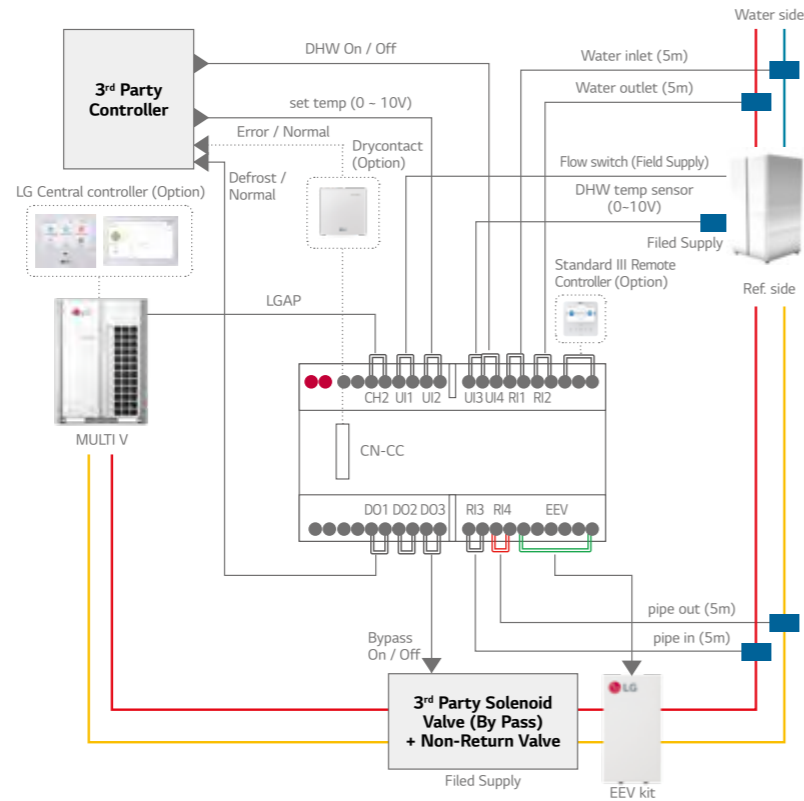

Installation scene with Modbus / LG Control (Optional) connection

Modbus+ DHW Only Setting

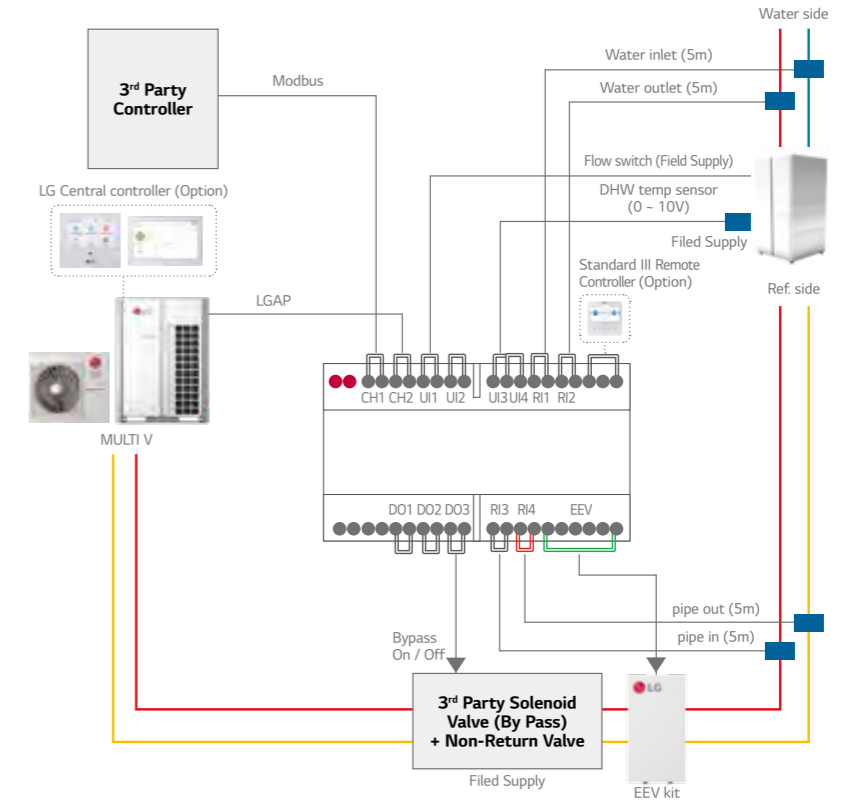

Contact signal + Heating / Cooling Setting

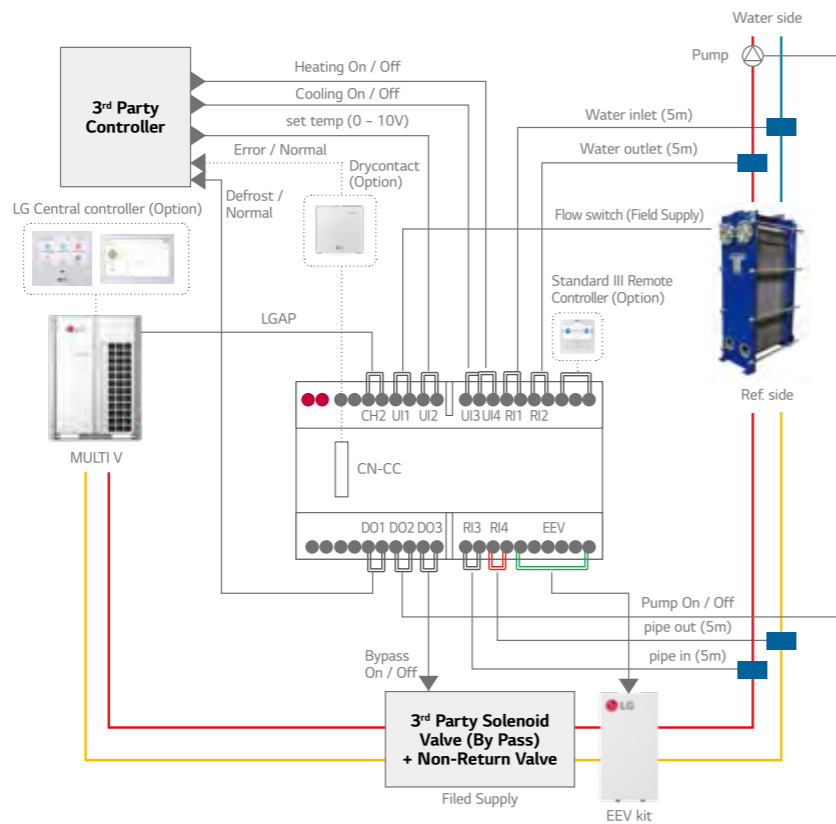

Modbus+ Heating / Cooling Setting

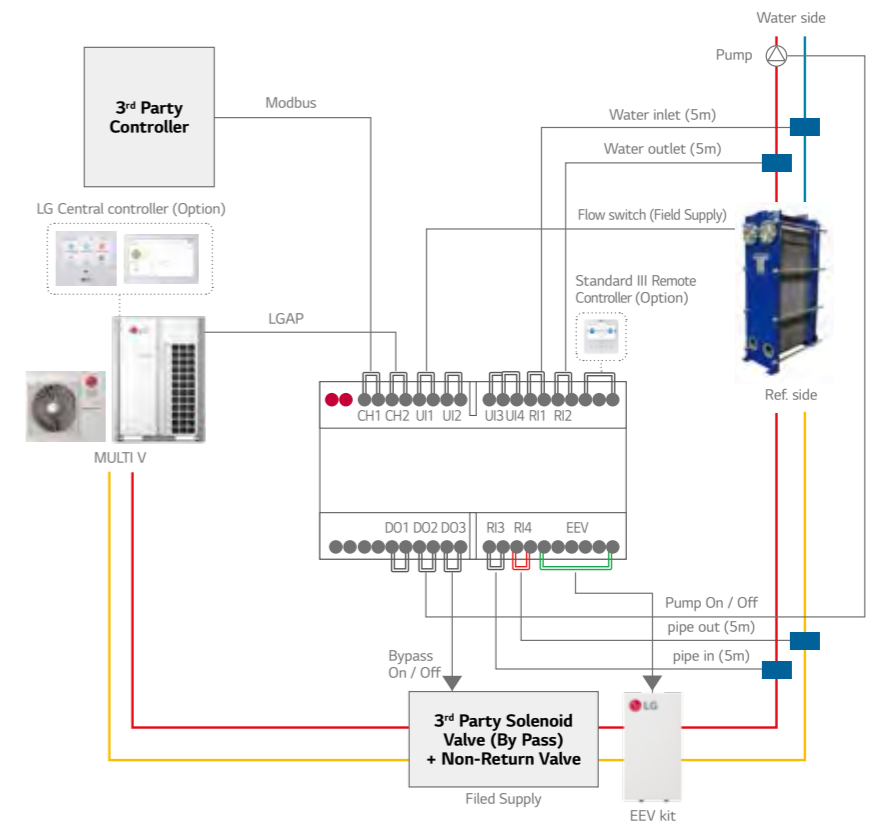

※ In case of Contact control, LG controllers can only support monitoring functions

VARIABLE WATER FLOW CONTROL KIT

Accessory developed for controlling the water flow.



PWFCN000
(MULTI V WATER IV)

Features

Function

- Water pump or valve control (0 ~ 10V)
- Minimum output voltage setting available
- Operation, error output (AC 250V, Max. 1A)
- Dry contact input and analog output for demand control
- Digital output for operation, error status (AC 250V, Max. 1A)

Advantage

- Water flow consumption reduction
- Pump electricity consumption reduction
- Including IO Module (Dry contact input, Analog input / output, Digital output)
- Using Dry contact and variable water flow control function simultaneously

Wiring Diagram

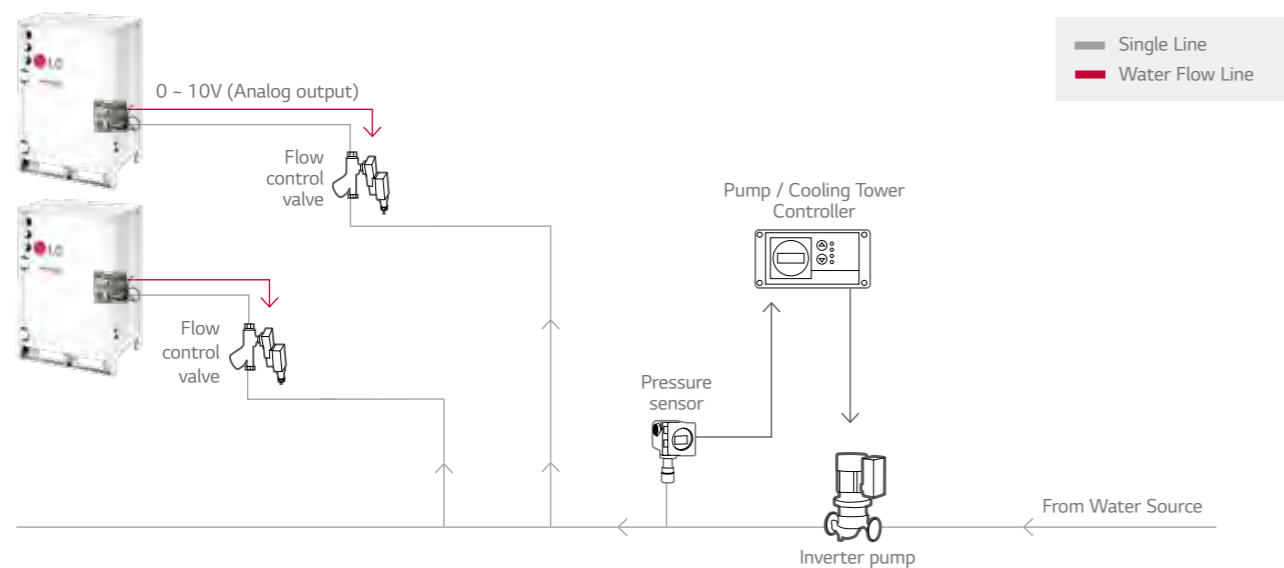

- Flow control valve : Regulates the flow or pressure of a fluid, normally responding to signals generated by independent devices.
- Flow Meter : Measures mass flow rate of a fluid traveling through a tube. (The mass flow rate is the mass of the fluid traveling past a fixed point per unit time.)
- Pressure Sensor : Measures the pressure.

LOW AMBIENT KIT

External integration module for cooling operation with -25 °C low ambient temperature.



PRVC2

Features

Function

- 25 °C Low ambient cooling operation by Low ambient kit and hood with damper (Analog output 0 ~ 10V)
- Demand control
- Low noise operation
- Output outdoor or indoor unit operation status (AC 250V, Max. 1A)
- Output error status (AC 250V, Max. 1A)

Description

- Low ambient kit supports -25 °C cooling operation by making stable condensing pressure with reducing air flow rate from hood and damper control given 0 ~ 10V proportional to condensing pressure.
- Low ambient kit provides IO Module function.
- External snow hood and air damper are required for this item.
- Transformer and terminal block are included.

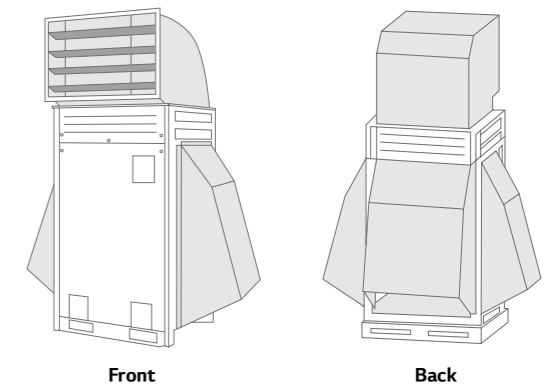

Front

Back

□ : Field Supply item

Models Applied

- MULTI V 5
- MULTI V IV

Installation Scene

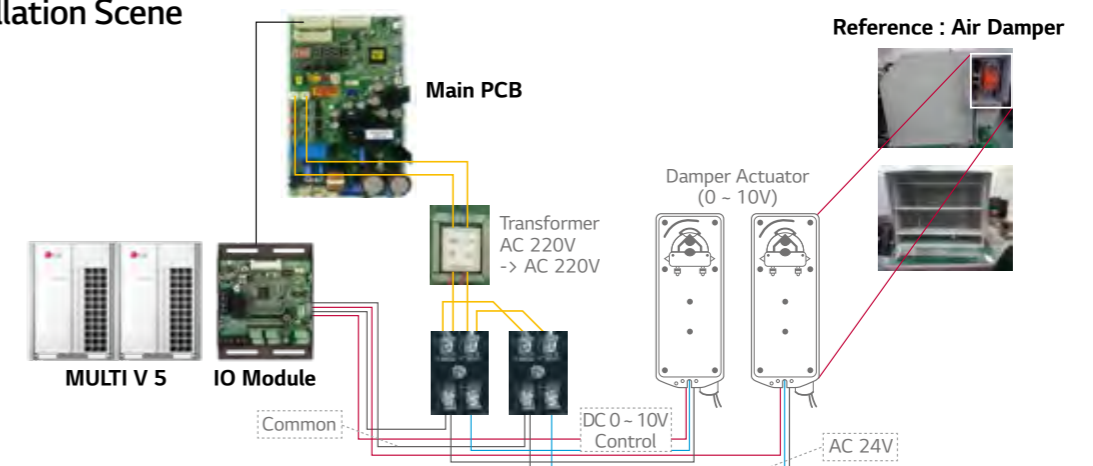

Note : The IO Module can control maximum three actuators. Please, review damper actuator's installation manual.

COOL / HEAT SELECTOR

Cooling only, heating only, and fan mode can be selected.



PRDSBM

Features

- Indoor unit mode control without central controller
- Select operation mode : Cooling, Heating, Fan mode
- Mode lock for cooling & heating mixing error-proof during the change of season

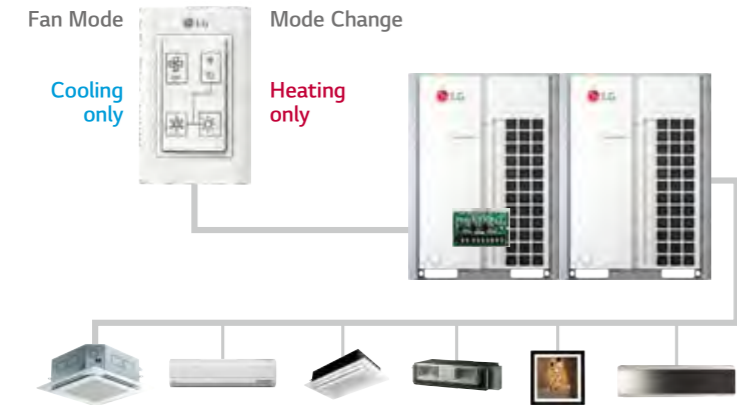

Models Applied

- MULTI V 5
- MULTI V IV
- MULTI V WATER S
- MULTI V WATER II
- MULTI V S
- MULTI V PLUS
- MULTI V WATER IV

Wiring Diagram

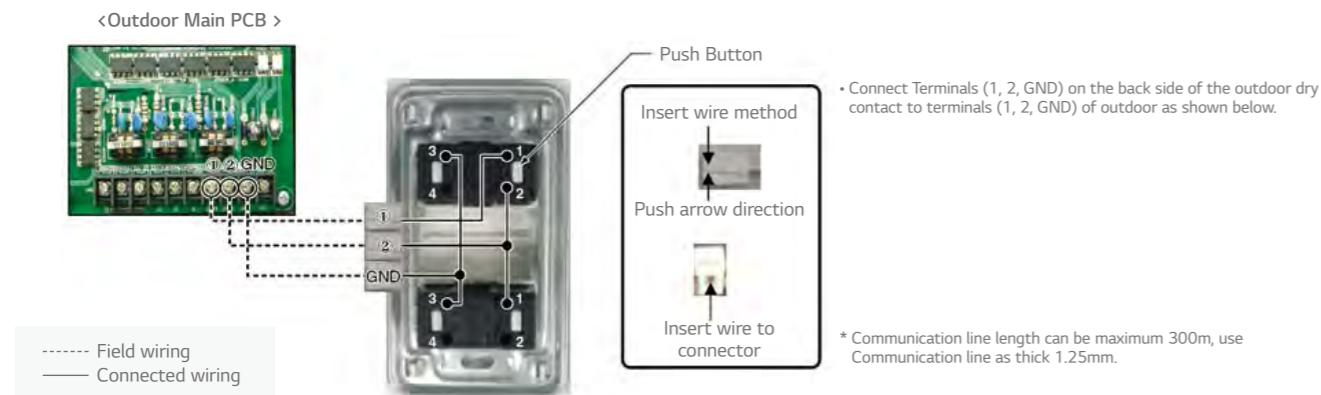

AHU KITS

A solution to connect LG's high efficiency system to the DX coil of an air handling unit for the maximum energy savings.

COMMUNICATION KIT



PAHCMR000

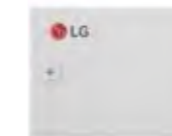

PAHCMS000

NEW CONTROL KIT



PAHCNM000

EEV KIT



PRLK048A0
PRLK096A0

NEW CONTROLLER MODULE



PAHCMM000



PAHCMC000



PRLK396A0

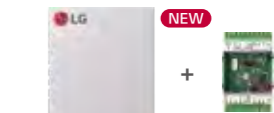

PRLK594A0

Specifications

Control Application Kit

Type	Model	Dimensions (mm)			Power Supply	IP Rating	Description
		W	H	D			
Communication Kit	PAHCMR000	300	300	155	1Ø, 220-240 V, 50/60 Hz	IP66	Return / Room air temperature control by DDC or LG individual / centralized controller.
	PAHCMS000	380	300	155	1Ø, 220-240 V, 50/60 Hz	IP66	Discharge air / Supply air temperature control by DDC or LG individual / centralized controller.
Controller Module	PAHCMM000	162	90	61	DC 12V	IP20	Main Controller module
	PAHCMC000	108	90	61	DC 12V	IP20	Communication Controller module
Control Kit	PAHCNM000	500	500	210	1Ø, 220-240 V, 50/60 Hz		Various AHU control functions with multiple DX coils (Maximum connectable ODU is 3 units)

Expansion Application Kit

Type	Model	Dimensions (mm)			Pipe Diameter (mm)	Capacity Index Range
		W	H	D	Liquid	
EEV Kit	PRLK048A0	217	404	83	12.7	3.6 ~ 28 kW
	PRLK096A0	217	404	83	12.7	28.1 ~ 56 kW
	PRLK396A0	349.5	345.5	180	19.05	56.1 ~ 112 kW
	PRLK594A0	409.5	345.5	180	19.05	112.1 ~ 168 kW

AHU KITS

Communication Kit

HIGH ENERGY EFFICIENCY

LG's DX AHU solutions' superior performance provides a highly efficient heat source system.

- High energy efficiency inverter system
- Large range of expansion application Kit : Max 168 kW EEV Kit ¹⁾
- Connected to various heat sources : MULTI V, MULTI V WATER, MULTI V S, SINGLE SPLIT

1) Maximum connectable EEV capacity for PAHCMR000, PAHCMC000 is 112 kW



DIVERSE OPTIONS FOR CONTROL

AHU communication kit can be connected to various control systems such as LG individual / central controller and DDC ¹⁾. It can be directly connected to DDC without separated controller, so DDC can receive product control and monitor information through contact signal or Modbus protocol.

- LG Individual / Central controller supported
 - LG controller stand alone or combination with DDC
- Direct wiring between DDC and AHU communication kit
 - Embedded Digital I/O and Analog Input
 - Modbus RTU protocol supported

1) DDC : Direct Digital Controller

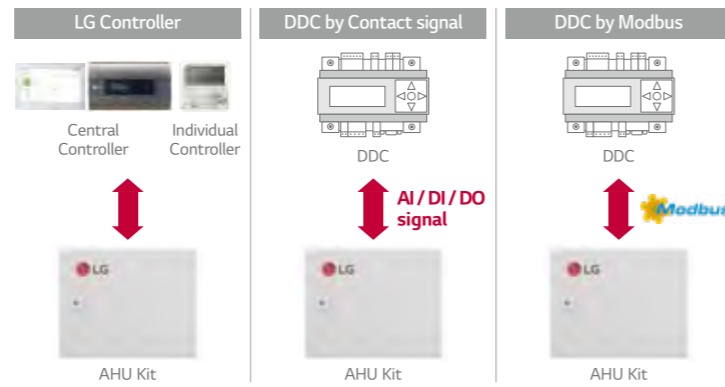

EXPANDABLE SYSTEM DESIGN

LG AHU system can be a suitable solution for various sites due to its application flexibility and wide range of line up with large capacity models. According to the required capacity, a single or multiple module combination is possible due to the AHU communication kit's modular design.

- Multiple module combination for large capacity AHU

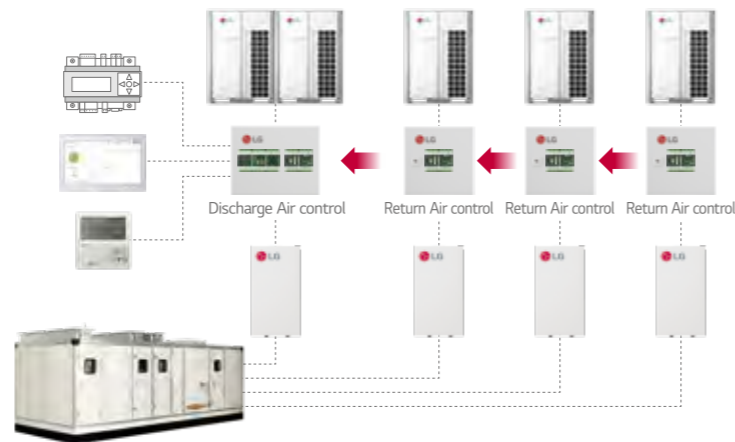

Single Split Application (Communication Kit & Controller Module)

Single Split + Return / Room Air Temperature Control

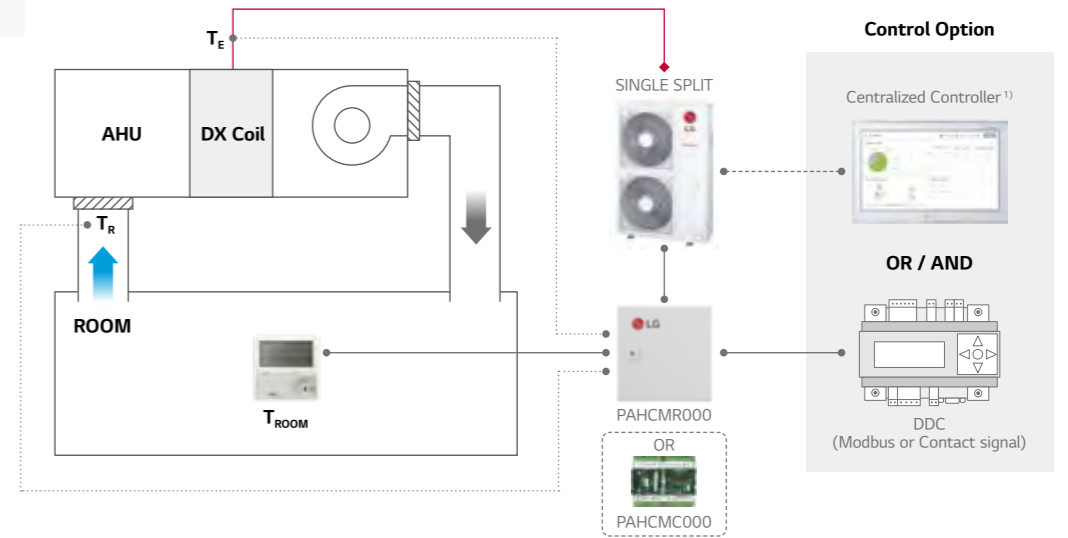
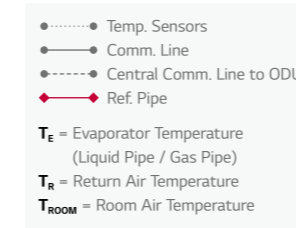

Single Split + Discharge Air Temperature Control

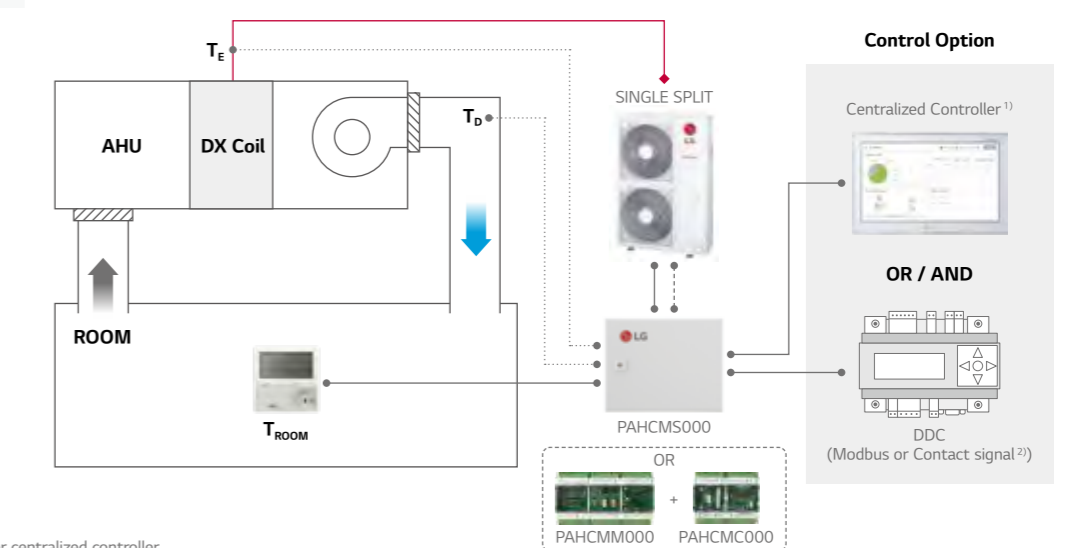
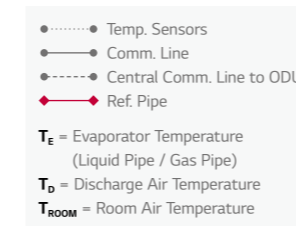

1) PI485 (PMNFP14A1) is required for centralized controller

2) In case of applying DDC with contact signal, discharge air temperature should be measured and controlled by DDC
 Note : For more detail, please refer to the PDB

AHU KITS

MULTI V Application (Communication Kit & Controller Module)

MULTI V + EEV Kit + IDU + Return / Room Air Temperature Control

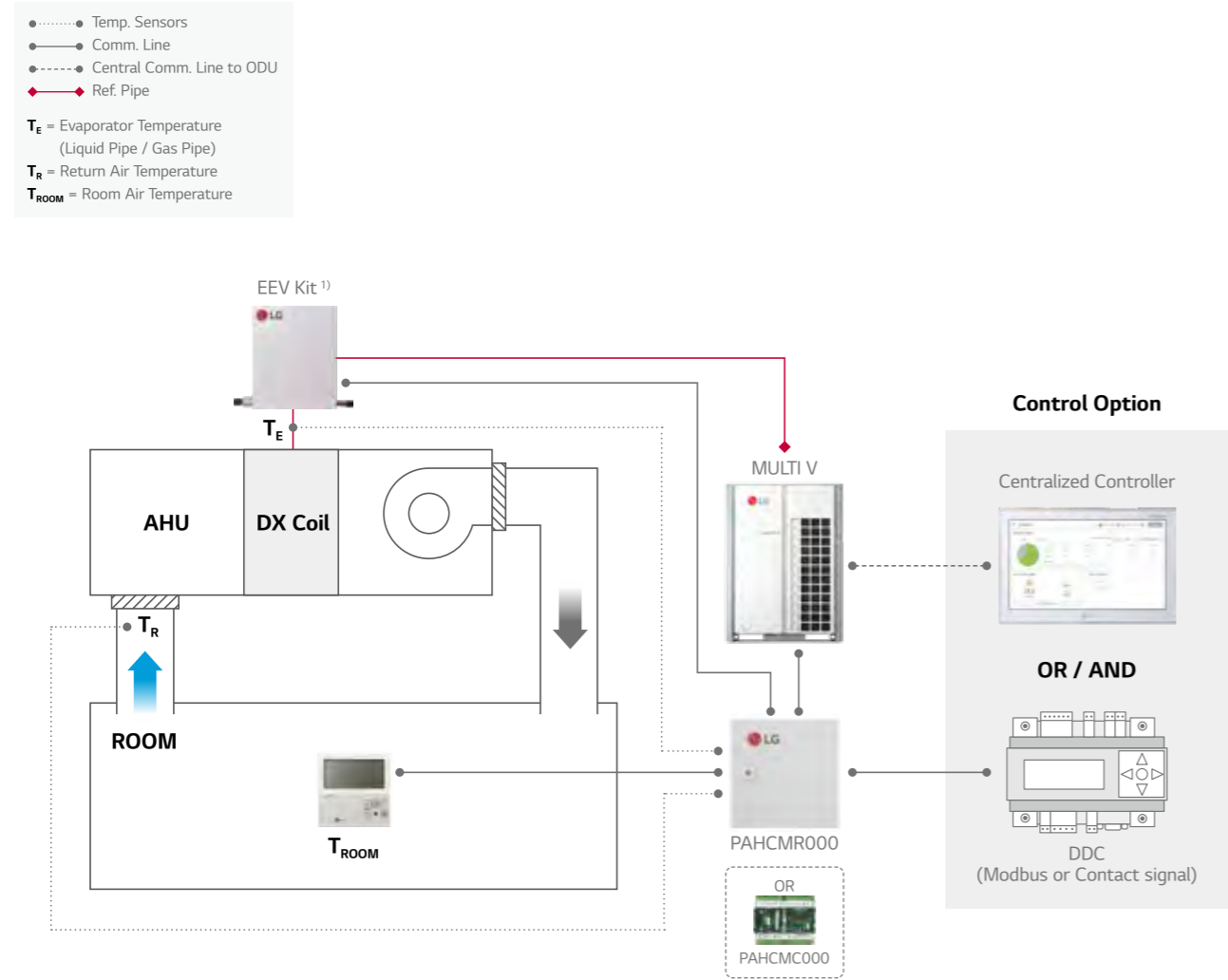

1) Multiple EEV kits can be applicable with multiple DX Coils and PAHCMR000s
 2) In case of applying DDC with contact signal, discharge air temperature should be measured and controlled by DDC
 Note : For more detail, please refer to the PDB

MULTI V + EEV Kit + Discharge Air Temperature Control

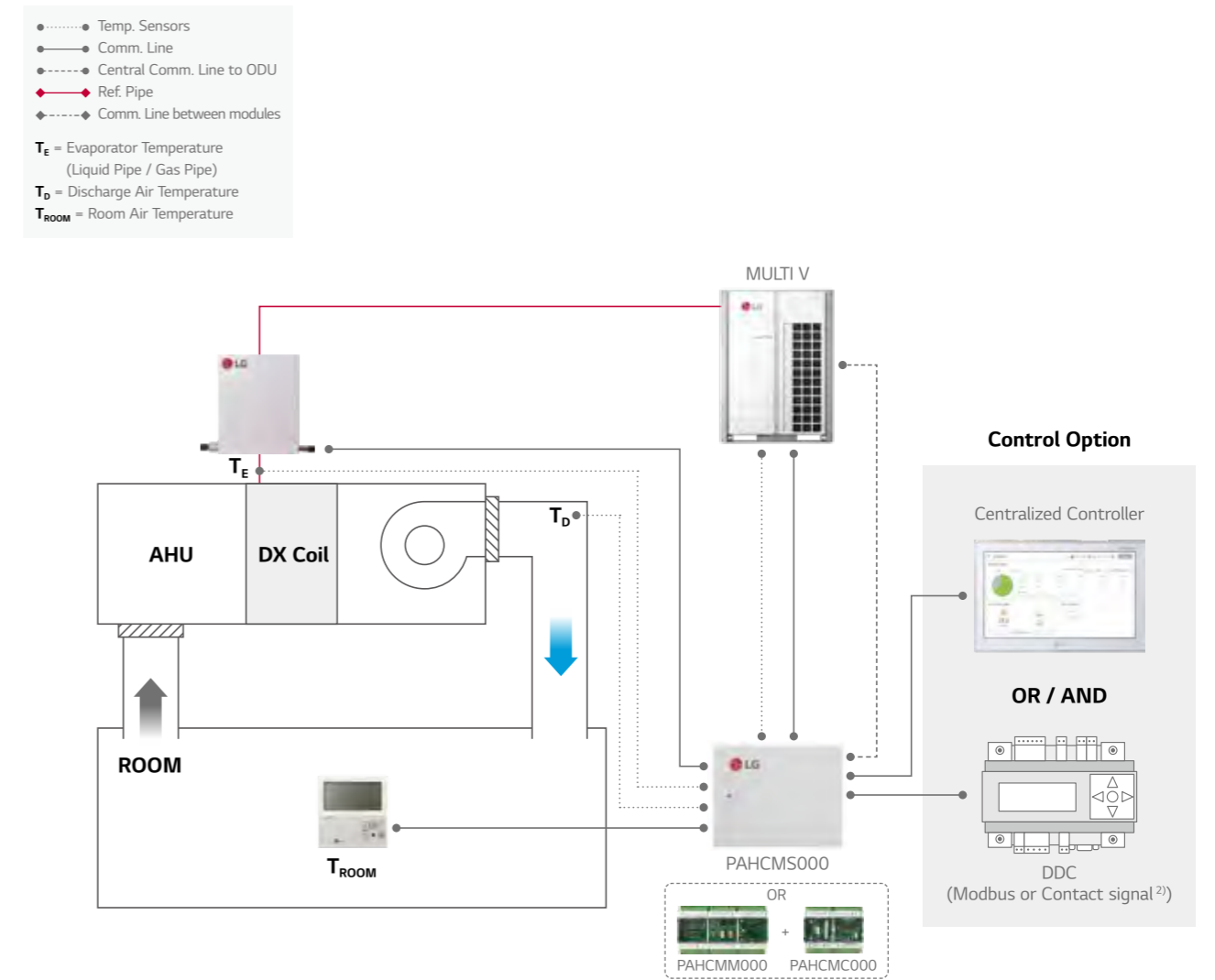

1) Multiple EEV kits can be applicable with multiple DX Coils and PAHCMR000s
 2) In case of applying DDC with contact signal, discharge air temperature should be measured and controlled by DDC
 Note : For more detail, please refer to the PDB

AHU KITS

Communication Kit Function

Communication with DDC via Contact Signal

Function List	PAHCMR000 (PAHCMC000)	PAHCMS000 (PAHCMM000 + PAHCMC000)	Type	Note
Operation On / Off	On / Off	On / Off	Digital Input (Non Voltage)	-
Operation Mode	Cooling / Heating	Cooling / Heating	Digital Input (Non Voltage)	Available operation mode can vary depending on the settings of Communication Kit
Return (Room) Air Temperature ²⁾	16 ~ 30 °C	-	Analog Input (DC 0-10 V / 20mA)	-
Control ¹⁾ Discharge Air Temperature ²⁾	-	-	-	Discharge air temperature should be controller directly by DDC using 'ODU Capacity Control'
Fan Speed ³⁾	-	High / Middle / Low	Digital Input (Non Voltage)	-
Forced Thermal	On / Off	-	Digital Input (Non Voltage)	-
ODU Capacity	-	40 ~ 100%	Analog Input (DC 0-10 V / 20mA)	-
Emergency Stop	-	Stop / Normal	Digital Input (Non Voltage)	-
Monitor Operation	On / Off	On / Off	Digital Output (Max : DC 30 V / 1 A, AC 250V / 1 A)	For PACHMR000, dip sw1-3 DO Type should be set 'Off' (Status). In this case, 'fan speed' cannot monitored by DO ports
Operation Mode	-	-	-	It needs to be checked through control signal
Fan Speed	High / Middle / Low	High / Middle / Low	Digital Output (Max : DC 30 V / 1 A, AC 250V / 1 A)	For PACHMR000, dip sw1-3 DO Type should be set 'On' (Fan Mode). In this case, 'On/Off, defrost, error Status' cannot monitored by DO ports
Defrost Operation	Defrost / Normal	Defrost / Normal	Digital Output (Max : DC 30 V / 1 A, AC 250V / 1 A)	For PACHMR000, dip sw1-3 DO Type should be set 'Off' (Status). In this case, 'fan speed' cannot monitored by DO ports
Error Alarm	Error/Normal	Error/Normal	Digital Output, Relay C contact (Max : DC 30 V / 1 A, AC 250V / 1 A)	For PACHMR000, dip sw1-3 DO Type should be set 'Off' (Status). In this case, 'fan speed' cannot monitored by DO ports
Compressor On / Off	-	On / Off	Digital Output, (Max : DC 30 V / 1 A, AC 250V / 1 A)	-

1) Control functions for LG individual and central controller are not available in case of using together with DDC via contact signal

2) The range of temp. is differ depending on the type of the controller.

3) To control fan speeds, DO port of the fan speed status should be connected to the fan control panel

Note : For more detail information, please refer to the product data book

Communication with DDC via Modbus protocol

Function List	PAHCMR000 (PAHCMC000)	PAHCMS000 (PAHCMM000 + PAHCMC000)	Note
Operation On/Off	On / Off	On / Off	
Operation Mode	Cooling / Heating / Fan	Cooling / Heating / Fan	
Return (Room) Air Temperature	16 ~ 30 °C	-	
Control ¹⁾ Discharge Air Temperature ²⁾	-	12 ~ 50 °C	Dip SW1-2 Discharge Temp. Control Type should be set 'On'
Fan Speed ³⁾	High / Middle / Low	-	
Forced Thermal On/Off	-	-	
ODU Capacity Control ²⁾	-	40 ~ 100%	Dip SW1-2 Discharge Temp. Control Type should be set 'On'
Emergency Stop	-	-	
Monitor Operation	On / Off	On / Off	
Operation Mode	Cooling / Heating / Fan	Cooling / Heating / Fan	
Return (Room) Air Temperature	○	-	Corresponding air temperature sensor connected to AHU Comm. Kit is required
Discharge Air Temperature	-	○	
Fan Speed	High / Middle / Low	High / Middle / Low	
Defrost Operation	Defrost/Normal	Defrost/Normal	
Error Alarm	Error / Normal, Error code	Error / Normal, Error code	
Compressor On / Off	On / Off	On / Off	

※ ○ : Applied, - : Not Applied

1) Control functions for LG individual and central controller are not available in case of using together with DDC via contact signal

2) In case of PAHCMS000, control type between "Discharge Air Temperature" and "ODU Capacity Control" is selectable

3) To control fan speeds, DO port of the fan speed status should be connected to the fan control panel

Note : For the Modbus memory map and more detail information, please refer to the product data book

Communication Kit Function

With LG Control system (Individual & Centralized Controller)

Function List	PAHCMR000 (PAHCMC000)	PAHCMS000 (PAHCMM000 + PAHCMC000)	Note
Operation On/Off	On / Off	On / Off	-
Operation Mode	Cooling / Heating / Fan	Cooling / Heating / Fan	Available operation mode can vary depending on the settings of Communication Kit
Control ¹⁾ Return (Room) Air Temperature ²⁾	16 ~ 30 °C	-	-
Discharge Air Temperature ²⁾	-	12 ~ 50 °C	Standard II : 16 ~ 30 °C Standard III : 12 ~ 50 °C (Available in April, 2020) Central Controllers : 12~50 °C
Fan Speed ³⁾	High / Mid / Low	High / Mid / Low	To control the AHU fan, dip switch 1-3 'DO type' should be set 'On (Fan Speed)' (PAHCMR000)
Monitor Operation	On / Off	On / Off	-
Operation Mode	Cooling / Heating / Fan	Cooling / Heating / Fan	-
Return (Room) Air Temperature	○	○	-
Discharge Air Temperature	-	○	-
Fan Speed	High / Middle / Low	High / Middle / Low	-
Defrost Operation	On / Off	On / Off	Only with Individual Controller
Error Alarm	Error Code	Error Code	Error code will be displayed on the screen
Compressor On/Off	On / Off	On / Off	Only with Individual Controller

※ ○ : Applied, - : Not Applied











1) Control functions for LG individual and central controller are not available in case of using together with DDC via contact signal

2) The range of setting temperature is different depending on the type of the controllers. And operation may different from setting range.

3) To control fan speeds, DO port of the fan speed status should be connected to the fan control panel

Note : For more detail information, please refer to the product data book

Compatibility with LG HVAC Controllers

Controller	Individual Controller			Centralized Controller				BMS Gateway	PDI	
	Premium	Standard III	Standard II	AC Ez	AC Ez Touch	AC Smart 5	ACP 5	AC Manager 5 ¹⁾	ACP Lonworks	Premium Standard
										
Model no.	PREMTA000 PREMTA000A PREMTA000B	PREMTB100 PREMTBB10	PREMTB001	PQCSZ250S0	PACEZA000	PACS5A000	PACP5A000	PACM5A000	PLNWkB000	PQNUD1S40 PPWRDB000
PAHCMR000	○	○	○	○	○	○	○	○	○	○
PAHCMS000	-	○ ²⁾	○	-	-	○	○	○	-	-

※ ○ : Applied, - : Not Applied

1) AC Manager 5 is an integrator, so the installation with AC Smart 5 or ACP 5 is required

2) Set temperature range of this model shall be extended April, 2020

Note : 1. Dry contact for indoor unit (PDRYCB000 / 400 / 300 / 500) is not applied

2. For more details, please refer to the product data book

AHU KITS

Outdoor Unit Compatibility

For Small Size Application (~ 15 kW) - Single Split

Type	Model	UUA1 (2.5 - 5.0 kW) ¹⁾	UUB1 (5.0 - 8.0 kW) ¹⁾	UUC1 (7.1 - 10.0 kW) ¹⁾	UUD1 / UUD3 (10.0 - 15.0 kW) ¹⁾
Communication Kit (Controller Module)	PAHCMR000 (PAHCMC000)	-	○	○	○
	PAHCMS000 (PAHCMM000 + PAHCMC000)	-	○	○	○
Control Kit	PAHCNM000	-	-	-	-

For Medium-Large Size Application (~ 672 kW) - MULTI V

Type	Model	MULTI V				MULTI V WATER	
		5	IV	III	S	IV	II
Communication Kit (Controller Module)	PAHCMR000 (PAHCMC000)	○	○	○	○	○	○
	PAHCMS000 (PAHCMM000 + PAHCMC000)	○	○	○	○	○	○
Control Kit	PAHCNM000	○	○	○	○	○	○

Expansion Application Kit Compatibility

EEV Kit Model	Capacity index (kW)		Control Application Kit (Maximum connectable EEV Kits)			Connection by ODU system		
	Min.	Max.	PAHCMR000 (PAHCMC000)	PAHCMS000 (PAHCMM000 + PAHCMC000)	PAHCNM000	MULTI V		Single Split
						Heat Pump	Heat Recovery	
PRLK048A0	3.6	28	○ (1)	○ (1)	○ (6)	○	○	-
PRLK096A0	28.1	56	○ (1)	○ (1)	○ (6)	○	○ (Max 33.7 kW)	-
PRLK396A0	56.1	112	○ (1)	○ (1)	○ (6)	○	-	-
PRLK594A0	112.1	168	-	○ (1)	○ (3)	○	-	-

※ ○ : Applied, - : Not applied

Note 1. Table of the outdoor unit compatibility is based on European regional model.

2. When connecting outdoor units in other areas, please check whether they are compatible or not.

3. Expansion application kit compatibility is based on capacity index of the system, it may changed according to system design condition.

Control Kit

List	Required Item
Heating / Cooling	SA / RA temperature sensor (or SA / RA temperature & humidity sensor)
Automatic Ventilation	SA / RA temperature, CO ₂ sensor, Damper actuator (OA, EA, MA)
Energy Saving (Cooling Mode Only)	SA temperature, OA / RA temp&humidity sensor, Damper actuator (OA, EA, MA)
Humidification	SA temperature, RA temperature & humidity sensor, Humidifier
Inverter Fan Control	SA / RA temperature, Static pressure sensor, Inverter driver for fan control
Filter Alarm	Difference pressure sensor
Smoke Detecting	Smoke detection sensor

RA : Return Air, EA : Exhaust Air, OA : Outdoor Air, SA : Supply Air, MA : Mix air (RA + OA)

Field Supplied Item

List	Required Specification	Apply Location
Temperature Sensor	- Power : AC 24V, Output signal : DC 0 ~ 10V - Temperature boundary : -50 ~ 50°C	- Apply to MA, SA, RA
Temperature & Humidity Sensor	- Power : AC 24V, Output signal : DC 0 ~ 10V - Temperature boundary : -40 ~ 70°C - Humidity boundary : 0 ~ 95% RH	- Apply to SA, RA, OA - Can not be applied to MA
Damper Actuator	- Power : AC 24V, In/Output signal : DC 0 ~ 10V - Rotation angle : 90°	- Apply to OA, EA, MA damper
Difference Pressure Sensor (for Filter)	- Power : AC 24V, Output signal : DC 0 ~ 10V * Boundary : 0 ~ 1000Pa - Switch type : Relay Open / Close	- Apply to filter
Static Pressure Sensor	- Power : AC 24V, Output signal : DC 0 ~ 10V - Boundary : 0 ~ 1000pa	- Apply to SA (for inverter control)
CO ₂ Sensor	- Power : AC 24V, Output signal : DC 0 ~ 10V - Boundary : 0 ~ 2000ppm	- Apply to RA duct
Smoke Detection Sensor	- Power : AC 24V, From : Contact point type	- Apply to RA duct

Various Control with Control kit – Multiple MULTI V + EEV Kits

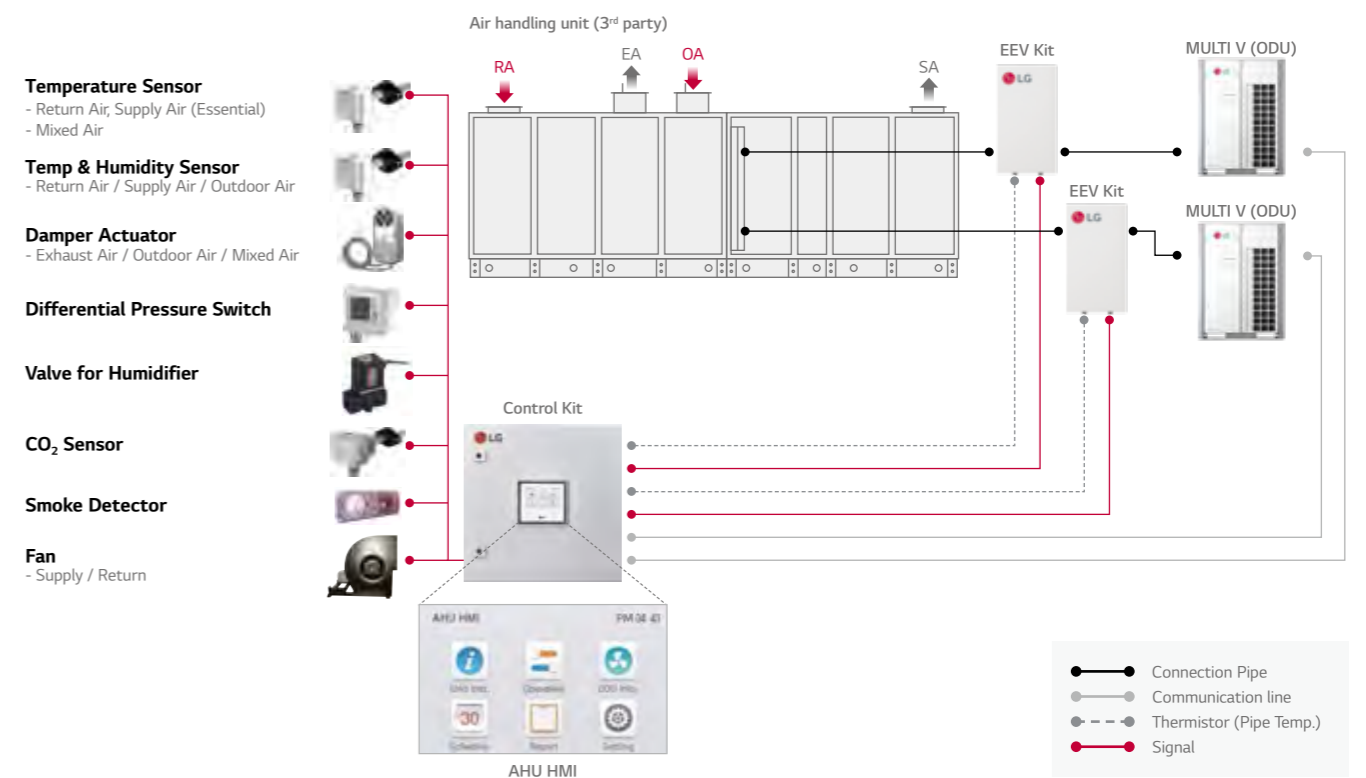

HOTEL

Hotel Control Solution



Guest Rooms

Air conditioner automatically switches off when guests depart

Integrated control of air conditioner with the hotel room controller

Air conditioner can be controlled with existing hotel thermostat

Prioritizes guest safety with refrigerant leak detection

Reception

Air conditioner control in conjunction with check-in or check out

Public Areas

Centralized management of the public areas

 Dry contact

 Dry contact

 Dry contact For thermostat

 Refrigerant Leak detector

 AC Smart 5 (Schedule)

SHOPPING MALL

Shopping Mall Control Solution



Retail

Proportionally distribute and manage the power consumption by tenants

Real-time system issue detection and alert

Maintenance Office

Reduces energy by checking operational trends

Atrium

Integrated management of AHU applied to large spaces

Chiller and VRF integrated control

 POI









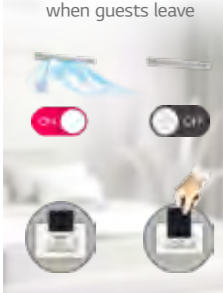
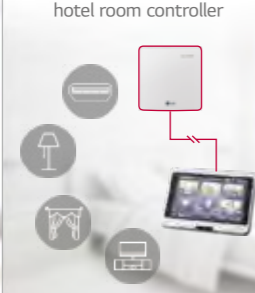

 Central controller (Operation trend)

 Central controller (Operation trend)

 Comm. Kit







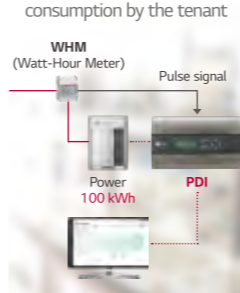
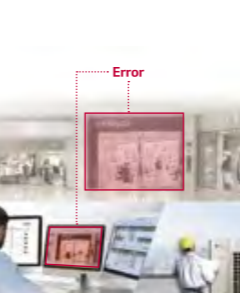

 Central controller (Operation trend) +  Chiller option kit

Design Proposal

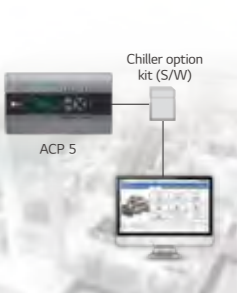
Guest Room				Lobby
<p>The air conditioner automatically turns off when guests leave</p> 	<p>Integrated control of air conditioner with the hotel room controller</p> 	<p>Control with existing hotel thermostat</p> 	<p>Guest safety is the first priority</p> 	<p>Air conditioner control in conjunction with check-in or check out</p> 
 PDRYCB400 2 contact point	 PDRYCB500 Modbus RTU (9,600bps)	 PDRYCB300 NEW PDRYCB320* 8 contact point	 PRLDNVSO Refrigerant leakage detector • 6,000ppm	 PACS5A000 AC Smart 5 • BMS Integration (BACnet IP, Modbus TCP)
<p>Input</p> <ul style="list-style-type: none"> • Operation On / Off <p>Output</p> <ul style="list-style-type: none"> • Operation On / Off status • Error alarm 	<p>Function</p> <ul style="list-style-type: none"> • Operation • Indoor temperature • Error alarm • Set run mode • Set temperature • Set fan speed 	<p>Input</p> <ul style="list-style-type: none"> • Universal Input* • Operation On / Off • Thermo On / Off • Operation mode (Fan / Heat / Cool) • Fan speed (Low / Middle / High) <p>Output</p> <ul style="list-style-type: none"> • Operation On / Off status • Error alarm 	 PREMTB100 Wired remote controller • 4.3 inch color LCD • Touch button	 PACP5A000 ACP 5 • BMS Integration (BACnet IP, Modbus TCP)

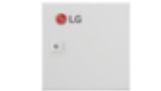
* Available from April 2020

Design Proposal

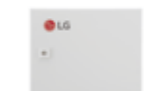
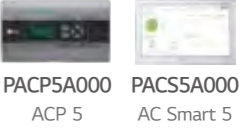
Retail	Maintenance Office	Atrium		
<p>Proportionally distribute and manage power consumption by the tenant</p> 	<p>Fast problem detection and alarms</p> 	<p>Reduces energy by checking operational trends</p> 	<p>Integrated management of AHU applied to large spaces</p> 	<p>Chiller and VRF integrated control</p> 
 PPWRDB000 PDI Standard (2 port) • Max. 128 IDU	 PACS5A000 AC Smart 5 • BMS Integration (BACnet IP, Modbus TCP)	 PAHMR000 AHU Comm. Kit • Return air	 PCHLLN000 Chiller option kit	
 PQNUD1S40 PDI Premium (8 port) • Max. 128 IDU	 PACP5A000 ACP 5 • BMS Integration (BACnet IP, Modbus TCP)	 PAHMS000 AHU Comm. Kit • Discharge air	 PACP5A000 ACP 5 + PACS5A000 AC Smart 5	

HOSPITAL

Hospital Control Solution

Hospital Ward

- Proper airflow management for patients
- Monitor the comfort level for each hospital ward
- Control fan speed and air volume

Service Zone

- Energy savings based on flexible scheduling

Lobby

- Centralized management of AHU for large spaces

- Wired remote controller
- Central controller (Comfort level)
- Dry contact
- Central controller (Schedule)
- Comm. Kit

Design Proposal

Hospital Ward			Service Zone	Lobby
Proper airflow management for patients	Monitor the comfort level for each hospital ward	External device interlock control	Energy savings based on flexible scheduling	Centralized management of AHU for large space
PTVSM AO Human detection sensor	PACS5A000 AC Smart 5	PDRYCB400 2 contact point	PACS5A000 AC Smart 5	PAHCMR000 AHU Comm. Kit
		Input • Operation On / Off		
PREMTB100 Wired remote controller	PACP5A000 ACP 5	Output • Operation On / Off status • Error alarm	PACP5A000 ACP 5	PAHCMS000 AHU Comm. Kit
• 4.3 inch color LCD • Touch button	• BMS Integration (BACnet IP, Modbus TCP)		• BMS Integration (BACnet IP, Modbus TCP)	• Return air
			• BMS Integration (BACnet IP, Modbus TCP)	• Discharge air

ACADEMIC INSTITUTION

Academic Institution Control Solution

Classroom

- Automatically save energy in the absence of students
- Central controls prevent students from arbitrary control

Lecture Hall

- Schedule management according to academic plan

Maintenance Office

- Integrated management of distributed buildings
- Centralized management with multiple interfaces

- Wired remote controller
- Central controller (Lock)
- Central controller (Schedule)
- Central controller (Multiple management)
- Central controller (HTML5)

Design Proposal

Class Room	Lecture Room	Maintenance Office
Automatically save energy in the absence of students	Central controls prevent students from arbitrary control	Schedule management according to academic plan
PTVSM AO Human detection sensor	PACS5A000 AC Smart 5	PACP5A000 ACP 5
PREMTB100 Wired remote controller	PACM5A000 AC Manager 5	PACM5A000 AC Manager 5
• 4.3 inch color LCD • Touch button	• BMS Integration (BACnet IP, Modbus TCP)	• BMS Integration (BACnet IP, Modbus TCP)

OFFICE

Office Control Solution

Maintenance Office

Energy savings and management throughout the building

Central controller (Energy Nxt)

Integrated management of HVAC with BMS system

Central controller (BMS Gateway)

Reduce costs by replacing BMS

Central controller (Operation trend) + ACS IO Module

Office Room

Reasonable power distribution to tenants

PDI

Server Room

24-hour backup management

Central controller (Backup operation)

Meeting Room

Energy savings based on occupancy detection

Wired remote controller

Design Proposal

Maintenance Office	Office Room	Server Room	Meeting Room
<p>Energy savings and management throughout the building</p> <p>Target Forecasting</p> <p>PACS5A000 AC Smart 5</p> <ul style="list-style-type: none"> BMS Integration (BACnet IP, Modbus TCP) <p>PACP5A000 ACP 5</p> <ul style="list-style-type: none"> BMS Integration (BACnet IP, Modbus TCP) 	<p>Integrated management of HVAC with BMS system</p> <p>BMS Protocol</p> <p>BMS System</p> <p>PPWRDB000 PDI Standard (2 port)</p> <ul style="list-style-type: none"> Max. 128 IDU <p>PQNUD1S40 PDI Premium (8 port)</p> <ul style="list-style-type: none"> Max. 128 IDU 	<p>Reduce costs by replacing BMS</p> <p>Pump Lighting Fan Sensor</p> <p>PEXPMB000 ACS IO Module</p> <p>PEXPM300 PEXPM200 PEXPM100 ACU IO Module</p>	<p>Reasonable power distribution to tenants</p> <p>WHM (Watt-Hour Meter) Pulse signal</p> <p>Power 100 kWh</p> <p>PDI</p> <p>PTVSM40 Human detection sensor</p> <p>PREMTB100 Wired remote controller</p> <ul style="list-style-type: none"> 4.3 inch color LCD Touch button

RESIDENTIAL

Residential Control Solution

Home

Anytime, anywhere air conditioner control and access

Wi-Fi Modem

Integrate systems for smart connectivity throughout

Modbus RTU

Bed Room

Use a familiar residential thermostat

Dry contact For thermostat

Simple interlocking control by remote control

Wired remote controller

Apartment / Residence

Stable system operation

Independent power module

Design Proposal

Home	Bed Room	Apartment
<p>Control your home air conditioner anytime, anywhere</p> <p>PWFMDD200 LG Wi-Fi modem</p> <p>Function</p> <ul style="list-style-type: none"> On / Off Fan speed Operation mode Vane control Reservation (Sleep, Weekly On / Off) Error check 	<p>Build a Smart house</p> <p>PDRYCB500 Modbus RTU (9,600bps)</p> <p>Function</p> <ul style="list-style-type: none"> Operation Indoor temperature Error alarm Set operation mode Set temperature Set fan speed 	<p>Use a familiar residential thermostat</p> <p>PDRYCB300 NEW PDRYCB320* 8 contact point</p> <p>Input</p> <ul style="list-style-type: none"> Universal Input* Operation On / Off Thermo On / Off Operation mode (Fan / Heat / Cool) Fan speed (Low / Middle / High) <p>Output</p> <ul style="list-style-type: none"> Operation On / Off status Error alarm <p>* Available from April 2020</p>
	<p>Simple interlocking control by remote control</p> <p>PREMTB100 Wired remote controller</p> <ul style="list-style-type: none"> 4.3 inch color LCD Touch button 	<p>Stable system operation when indoor unit power is lost</p> <p>PRIP0 Independent power module</p> <ul style="list-style-type: none"> EEV full close function

ACCESSORIES

MECHANICAL ACCESSORIES / PIPING ACCESSORIES



CASSETTE PANEL

The Independent Vane Operation makes desired and comfortable air flow.

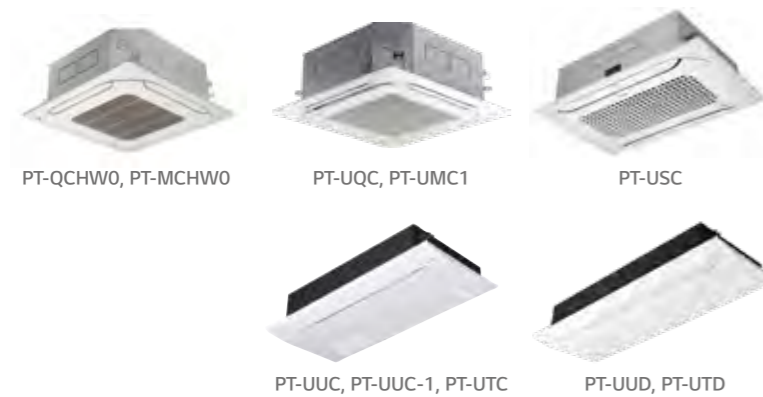

Model Name & Applied Products

- 4 Way Cassette**
PT-MCHW0
PT-QCHW0
PT-UQC / PT-UMC1
- 2 Way Cassette**
PT-USC
- 1 Way Cassette (Grill Type)**
PT-UUC / PT-UUC1 / PT-UTC
- 1 way cassette (Panel Type)**
PT-UUD / PT-UTD

Key Features

- Independent vane operation uses separate motors, making it Possible to control all 1, 2, and 4 vanes independently.
- The detachable corner design makes it easy to adjust the hanger during installation and to check for leakages in the drain pipe and refrigerant pipes.

Compact and Stylish Design

- New 4 way cassette panel adapted unibody shape and matching with into the ceiling.
- Panel size is fit into the ceiling tile.

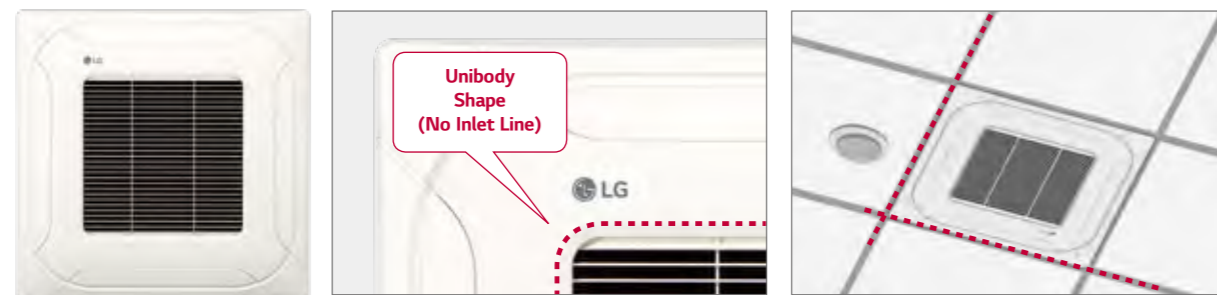

Specification

Model	Suction Type	Color (RAL)	Gloss	Weight (kg)	Dimension (mm)			Applied Model Capacity (kW)*					
					W	H	D	Single Split		MULTI Split		MULTI V	
								R32	R410A	R32	R410A	R410A	
4 Way	PT-QCHW0	Grill	Morning Fog (RAL 9001)	-	3.0	620	35	620	2.5 ~ 5.0	2.5 ~ 5.0	1.5 ~ 5.3	1.5 ~ 5.3	1.6 ~ 6.2
	PT-MCHW0	Grill	Morning Fog (RAL 9001)	-	6.3	950	35	950	6.8 ~ 14.6	6.8 ~ 14.6	6.7	-	7.1 ~ 15.8
	PT-UQC	Grill	Morning Fog (RAL 9001)	-	3.0	700	22	700	2.5 ~ 5.0	2.5 ~ 5.0	-	1.5 ~ 5.3	1.6 ~ 6.2
2 Way	PT-UQC	Grill	Morning Fog (RAL 9001)	-	5.6	950	25	950	6.8 ~ 14.6	6.8 ~ 14.6	-	6.7	7.1 ~ 15.8
	PT-USC	Grill	Morning Fog (RAL 9001)	-	4.7	1,100	28	690	-	-	-	-	2.8 ~ 7.1
1 Way	PT-UUC	Grill	Noble White (RAL 9003)	○	4.6	1,100	34	500	-	-	-	-	2.2 ~ 3.6
	PT-UUC1	Grill	Noble White (RAL 9003)	-	4.4	1,100	34	500	-	-	2.6 ~ 3.5	2.6 ~ 3.5	-
	PT-UTC	Grill	Noble White (RAL 9003)	○	5.5	1,420	34	500	-	-	-	-	5.6 ~ 7.1
	PT-UUD	Panel	Noble White (RAL 9003)	○	4.6	1,100	34	500	-	-	-	-	2.2 ~ 3.6
	PT-UTD	Panel	Noble White (RAL 9003)	○	5.5	1,420	34	500	-	-	-	-	5.6 ~ 7.1

* Based on cooling capacity
 ※ ○ : Applied, - : Not applied

DUAL VANE CASSETTE PANEL

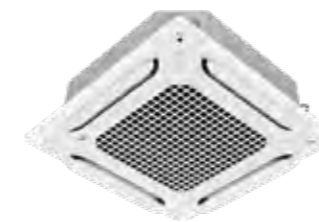

Model Name

- PT-AAGW0
- PT-AEGW0
- PT-AFGW0

Key Features

Model	Function					
	Dual Vane	Wi-Fi	Floor Temperature Sensor	Air Purification	Elevating Grille	Occupancy Sensor
PT-AAGW0	○	Optional	X	X	X	Optional
PT-AEGW0	○	Optional	X	X	○	Optional
PT-AFGW0	○	Optional	○	Optional	X	Optional

Specification

Model	Suction Type	Color (RAL)	Gloss	Weight (kg)	Dimension (mm)		
					W	H	D
PT-AAGW0	Grid	White (RAL 9003)	-	7.1	950	35	950
PT-AEGW0	Grid	White (RAL 9003)	-	8.5	950	35	950
PT-AFGW0	Grid	White (RAL 9003)	-	7.5	950	35	950

Air Purification Kit

Model	Image	Model name	Dielectric Dust collecting filter	Photocatalytic Deodorizing filter	HVPS	Ionizer
			○	○	○	○
Air cleaning kit		PTAHMPO	○	○	○	○

CASSETTE COVER

Cover in case of exposed cassette installation.

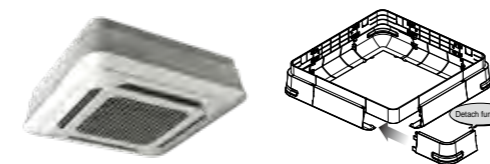

Model Name

- PTDCM / PTDCQ

Applied Products

4 Way Cassette (for chassis TP, TN, TM, TQ, TR)

Included Parts

- Cover A, Cover B
- Cover C, Cover D
- Screws
- Installation Manual

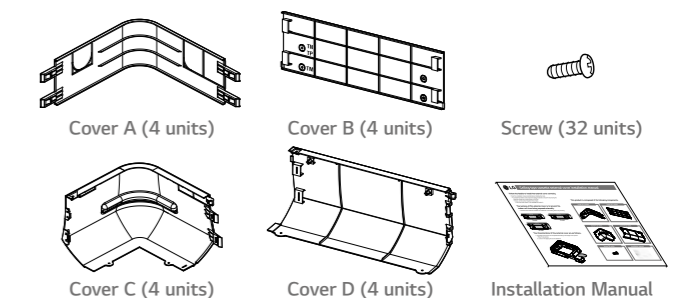

Key Features

- Specially designed for indoor unit
- Covers the side area of cassette
- Gives elegant looks
- Light weight

Specification

Model	Front Panel	Weight (kg)		Dimensions (mm)			
		NET	Gross	W	H	D	
PTDCM	PT-UMC / PT-UMC1	TP / TN	5.9	8.8	1,157	1,157	268
		TM	5.9	8.8	1,157	1,157	310
PTDCQ	PT-UQC	TR	5.0	7.2	907	907	268
		TQ	5.0	7.2	907	907	310

CO₂ SENSOR

CO₂ sensor in ventilation system.



Model Name
AHCS100H0

Applied Products

LZ-H025GBA4
LZ-H035GBA5 / LZ-H050GBA5
LZ-H080GBA5 / LZ-H100GBA5
LZ-H150GBA5 / LZ-H200GBA5

Applicable Products

LZ-H050GXN0 / LZ-H080GXN0
LZ-H100GXN0 / LZ-H050GXH0
LZ-H080GXH0 / LZ-H100GXH0

Key Features

Specification

- Applied Model : ERV (Embedded), ERV DX (Option)
- Supply voltage : DV12V ± 5%
- Output : 0.6 ~ 4.4V (Linear output, 240 ~ 1,760 ppm CO₂)
- Accuracy : ± 10% (2 days after installation)

Description

- The product is especially designed to detect CO₂.
- This model requires Standard III Wired Remote Controller for display.

Dimensions (Unit : mm)

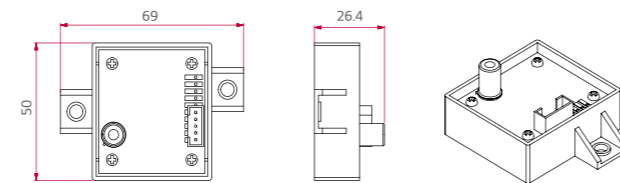

Key Application

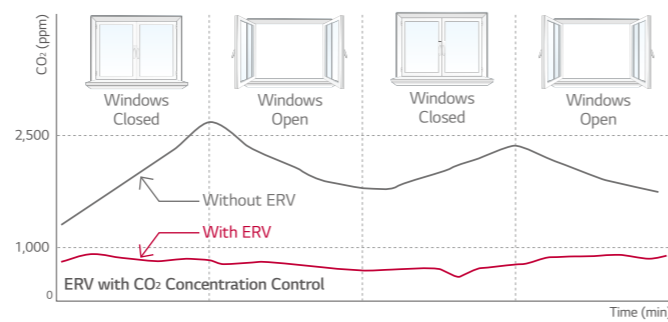
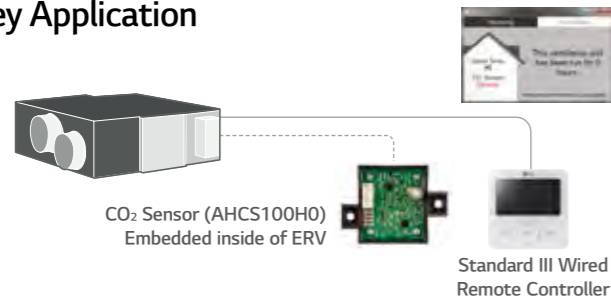

How to Install

1. Remove a screw on the service cover. Pull the service cover fixing bracket(1), then remove the service cover(2). Remove two elements(3) and two air filters(4).
 2. Install the sensor with two screws.
 3. Remove a screw, then remove the right side of element rail(5).
 4. Press the holder(6) into the hole to fix the CO₂ sensor cable(7).
 5. Connect the wire terminal to the CN-CO₂ port of PCB.
- ※ Airflow can be controlled by concentration of CO₂, after setting automatic operation mode at remote controller.
※ Use the screwdriver whose total length is less than 250mm.

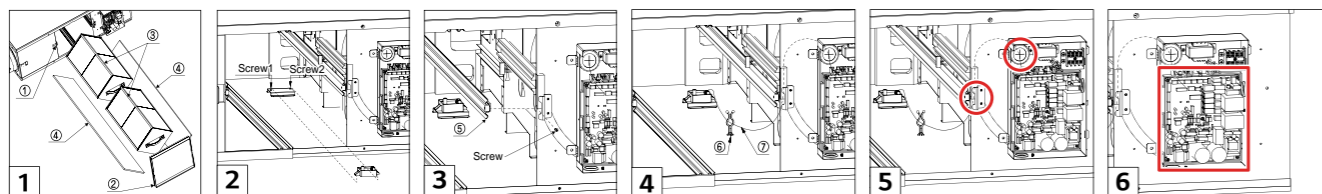

REFRIGERANT LEAKAGE DETECTOR

R410A refrigerant leakage detector ensures room safety.



Model Name
PRLDNV50

Applied Products

MULTI V 5
MULTI V IV Heat Pump & Heat Recovery
MULTI V WATER IV

Key Features

- This detector senses refrigerant leakage when the refrigerant concentration exceeds 6,000ppm. (The green and red LED lights blink simultaneously.)
- Alarm is "on" when refrigerant leaks out more than 6,000ppm for 5 seconds. If it is reduced less than 6,000ppm for 5 seconds, alarm is "off".
- When the alarm of the refrigerant leak detector is switched on the user must ventilate the room until the alarm is disabled.
- The detector has to be installed inside the room and it should be installed 300 ~ 500mm above the floor.

Specification

Parts	Specification	
Sensor	Rated Voltage (V)	DC 5.0 ± 5%
	Dimensions (W x H x D, mm)	31 x 44 x 20
	Weight (g)	22
	Detectable Refrigerant	R410A
	Detected Concentration (ppm)	0 / 6,000 Alarm Off / On
	Operating Temperature Range (°C)	-10 ~ 50
	Preserved Temperature Range (°C)	-40 ~ 60
Connecting Cable	Average Power Consumption (mA)	35
	Cable Length (m)	10
	Dimensions of Front Plate (W x H x D, mm)	80 x 110 x 44.6
Sensor Protective Cover	Dimension of Backplate (W x H x D, mm)	80 x 110 x 6.5

This function available for ARU****L**5 and 4 (MULTI V 5, MULTI V IV H/P, H/R model)

Included Parts



Key Application

Refrigerant Leakage Detector has three application methods.

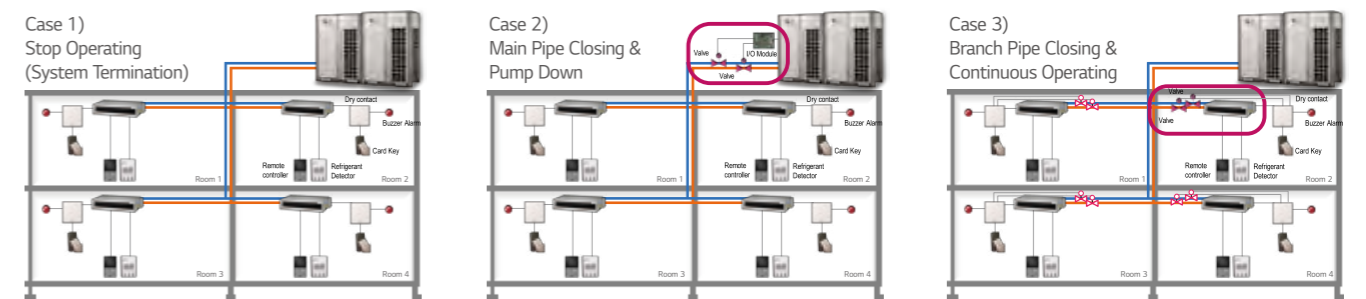

Accessory Specification (To realize the case 2 application)

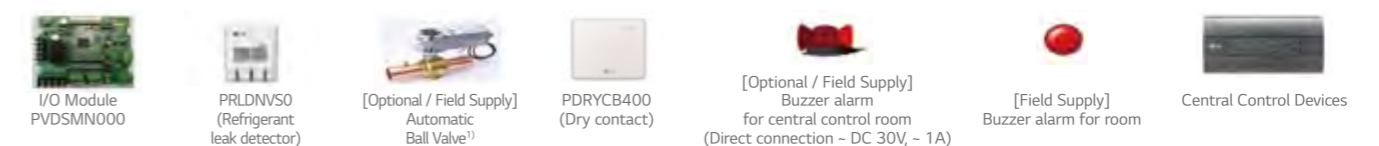

※ Necessary accessory

1) Please contact to subsidiary to get the recommended specification. (LG Electronic don't provide this accessory)

EEV KIT (FOR INDOOR UNIT)

MULTI V EEV KIT is specially designed to reduce noise and make comfort environment.



Key Features

- Decreasing noise level of Multi V Indoor units and easy installation.

Key Application

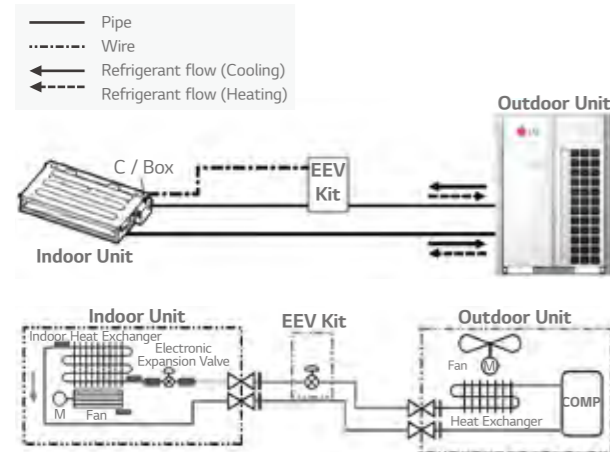

How to Install

- Open Indoor unit's control box cover.
- Open fully indoor unit's EEV through vacuum mode of ODU setting.
- Detach the Indoor unit's EEV connector from PCB and then push the reset button of Outdoor unit's PCB.
- After connecting indoor unit's EEV CONNECTOR, repeat the process ① & ②. Then, connect the EEV CONNECTOR of EEV KIT in PCB of indoor unit.
- Finally connect the lead wire of the EEV Kit to the indoor unit's PCB.
- Assemble the control box cover.

Model Name

PRGK024A0

Applied Products

Indoor Unt	Model	Chassis	Applicable
Cassette	1 Way Cassette	TU	○
	2 Way Cassette	TT	N/A
		TS	○(-5.6kW)
		TR	○
	4 Way Cassette	TQ	○(-4.5kW)
		TP	N/A
Duct	High Sensible	TN	N/A
		TM	-
		BG	-
	High Static	BR	-
		B8	-
		B8	-
Duct	Middle Static	M1	○(-5.6kW)
		M2	-
		M3	-
	Low Static	L1	○
		L2	-
		L3	-
Etc	Floor Standing	CE	○
		CF	-
	Convertible	VE	○
	Ceiling Suspended	V1	-
		V2	-
		SJ	○
Etc	Wall Mounted	SK	○
		SV	-
	Art Cool	SF	○
	Console	QA	○
		K2	-
	HYDRO KIT	K3	-

※ ○ : Applied, - : Not applied, N/A : Not Applicable

EEV Kit can be applied for the space which requires quiet environment and noise sensitive space.

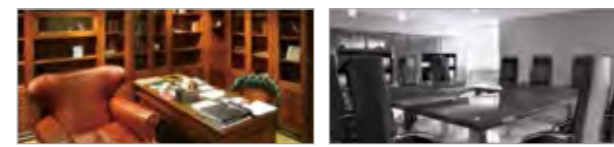
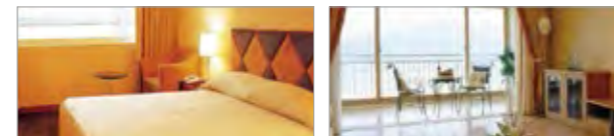

Note : If you don't use EEV of same specification, Cooling (Heating) capacity could be decreased.

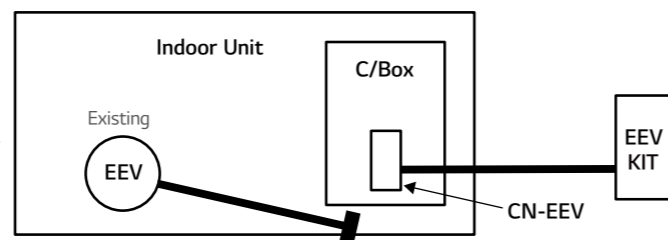

IR RECEIVER

IR RECEIVER can be connected to ceiling concealed duct and floor standing unit which the customer wants to control by wireless remote controller.



Model Name

PWLRVN000

Applied Products

MULTI V Indoors (Ceiling Concealed Duct, Floor Standing Units)

Key Features

- Designed for wireless control
- Indication lamps (3 colors) and Self-diagnosis function

Key Application

Note : Do not install both the IR Receiver and Wired Remote Controller. This may cause malfunctions.

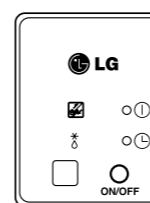
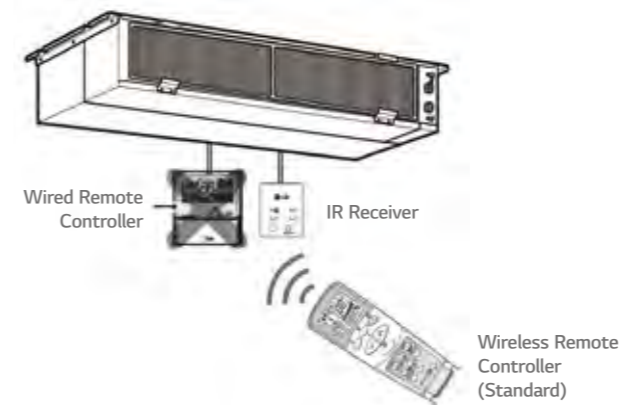

Operation of Indication Lamps

- Emergency Operation button :** Turns the indoor unit on or off when remote controller is not working.
- Signal Detector :** Receives the signal from remote controller.
- Timer lamp (Green) :** Lights up during the timer operation.
- Hotstart lamp (Orange) :** Lights up during the pre-heating operation, defrost operation as well as latent heat removal operation in heat mode. Available only for the heat pump models, not cooling only models.
- System On / Off lamp (Red) :** Lights up during system controller operation.
- Filter Sign lamp (Green) :** Lights up after 2,400 hours from the time of first power on operation.

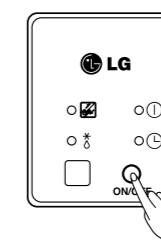
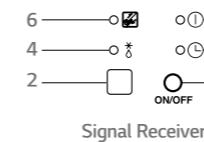

Test Run Mode

After installing the product, you must run a Test Run mode. Press the Emergency Operation button for 5 seconds, until the LED flickers. Then the indoor unit, duct runs cooling mode for 18 minutes, where the setting temperature is 18°C and the fan speed is high.

INDEPENDENT POWER MODULE

It closes EEV in indoor unit when power cut.



Model Name

PRIPO

Applied Products

MULTI V Indoor Units

Key Features

- Independent Power Module is specially designed to close the Indoor EEV when power cut-off.
- Supply Voltage : DC 12V ± 50%

Included Parts

Model	PRIPO			(Others)
Item	Independent Power Kit	Screw	Clamp (Tie Wrap)	• Harness 1 (1m) • Harness 2 (1m) • Harness 3 (1m) • Installation Manual • Insulation (PE)
Q'ty	1	2	4	

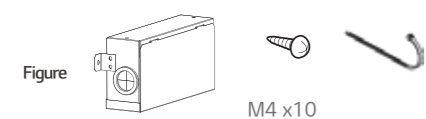

Key Application

If the EEV is opened due to power cut off, liquid refrigerant flows into compressor. It could damage the compressor in cooling mode. Also condensing might be happened for unclosed EEV's indoor unit due to flow of refrigerant.

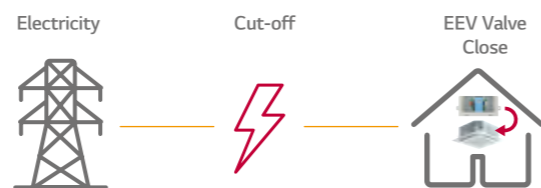

How to Install

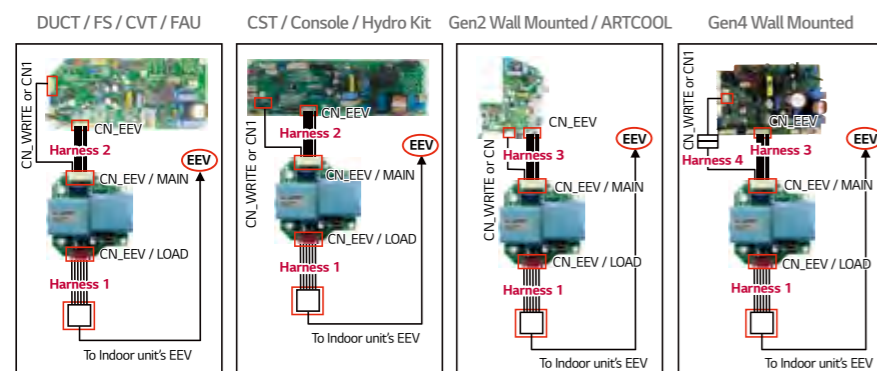

- ① Turn the power off using circuit breaker.
- ② Disconnect the EEV cable of the indoor unit's PCB (CN-EEV)
- ③ Connect the independent power module (CN-EEV/LOAD) to the indoor unit's EEV, using harness 1.
- ④ Connect the independent power module (CN-EEV/MAIN) to the indoor unit's PCB (CN-EEV/CN-WRITE), using harness 2 or 3.
- ⑤ Supply the power.

* FS : Floor Standing
* CVT : Convertible
* FAU : Fresh Air Intake Unit
* CST : Cassette

AUXILIARY HEATER RELAY KIT

Providing an efficient way to add auxiliary heat.



Model Name

PRARS1

Applied Products

Wall Mounted, Art Cool Mirror, Art Cool Gallery

Model Name

PRARH1

Applied Products

1, 2, 4 Way Ceiling Cassette, High Static Ducted, Low Static Ducted, Ceiling Suspended

Key Features

- Provides two stages of auxiliary heat for indoor unit.
- Provides ability to use the two stage auxiliary heater as the primary or secondary heating source.

Included Parts

Model	PRARH1			
Item	Auxiliary Heater Relay Kit	Screw	Insulation	Installation Manual
Q'ty	1	2	2	1

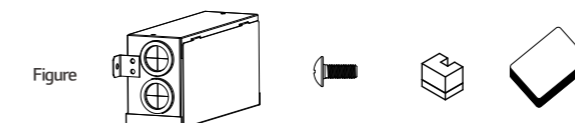

Model	PRARS1			
Item	Auxiliary Heater Relay Kit	Screw	Insulation	Installation Manual
Q'ty	1	2	2	1

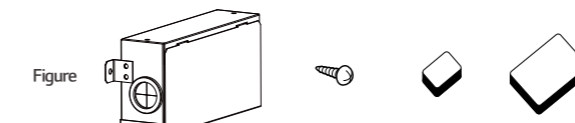

Key Application

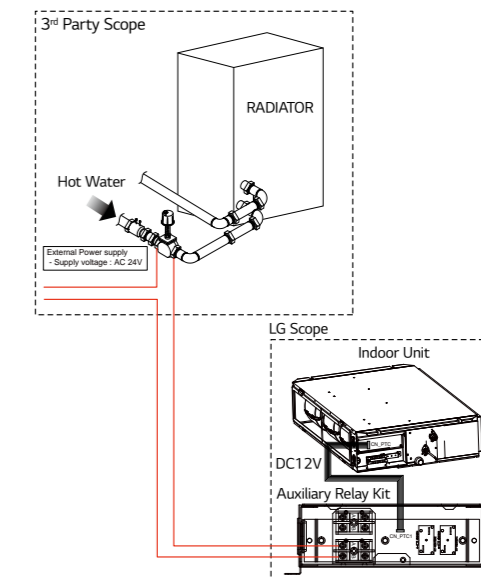

How to Install

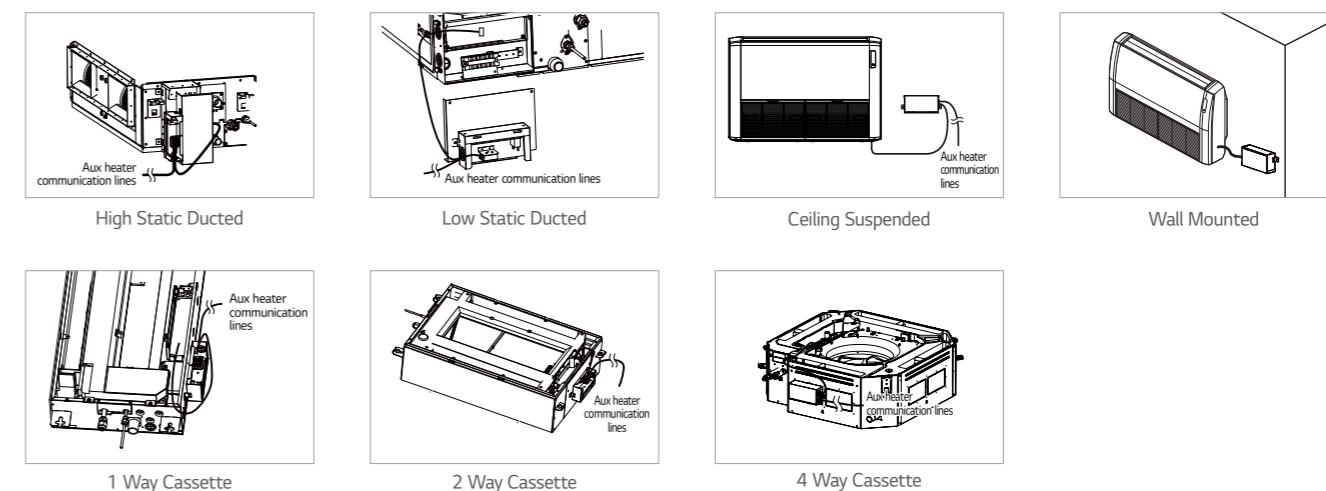

HEAT RECOVERY



Model Name

- PRHR023 (2 Branch Unit)
- PRHR033 (3 Branch Unit)
- PRHR043 (4 Branch Unit)
- PRHR063 (6 Branch Unit)
- PRHR083 (8 Branch Unit)

Applied Products

- MULTI V 5
- MULTI V IV
- MULTI V WATER IV

Key Features

- Max. 64 indoor units can be connected (Max. 8 indoor units per branch)
- It is easy to install due to the automatic search algorithm for piping detection.
- Subcooling cycle in HR unit makes the system efficiency maximum.

Connection Capacity

Maximum number of connectable indoor units :
64 IDUs / HR unit (in case of 8 ports model)

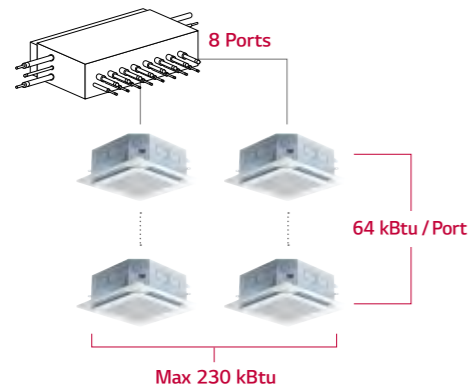

Flexible Connection

Series connection can be installed without pipes crossing.

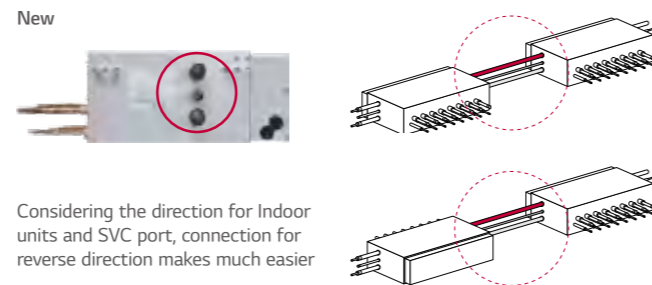

Considering the direction for Indoor units and SVC port, connection for reverse direction makes much easier

Reduce Noise

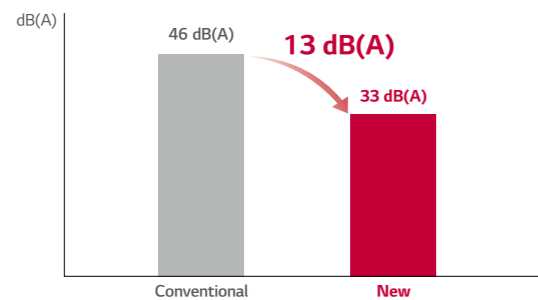

Test Condition (ISO Standard)
 - Temp. : (Cooling) 27°C DB / 19°C WB, 35°C DB / 24°C WB
 (Heating) 20°C DB / 15°C WB, 7°C DB / 6°C WB
 - Operating : cooling → heating switching operation

Included Parts

- HR unit (1EA)
- Hanging bolts M10 or M8 (4EA)
- Nut M8 or M10 (8EA)
- Washers M10 (8EA)
- Reducers

Specification

Model		PRHR023	PRHR033	PRHR043	PRHR063	PRHR083		
Number of Branch	EA	2	3	4	6	8		
Maximum Connectable Capacity of Indoor Units (Per branch / unit)	kW	17.5 / 35	17.5 / 52.5	17.5 / 69.5	17.5 / 69.5	17.5 / 69.5		
Maximum Number of Connectable Indoor Units Per Branch	EA	8	8	8	8	8		
Nominal Input	Cooling	kW	0.040	0.040	0.040	0.076	0.076	
	Heating	kW	0.038	0.038	0.038	0.072	0.072	
Net. Weight	kg	18.5	20.3	22.0	28.3	31.8		
Dimensions (W x H x D)		mm	786 x 218 x 657	786 x 218 x 657	786 x 218 x 657	1,113 x 218 x 657	1,113 x 218 x 657	
	Indoor Unit	Liquid	mm (inch)	9.52 (3/8)	9.52 (3/8)	9.52 (3/8)	9.52 (3/8)	9.52 (3/8)
Gas		mm (inch)	15.88 (5/8)	15.88 (5/8)	15.88 (5/8)	15.88 (5/8)	15.88 (5/8)	
Piping Connections	Outdoor Unit	Liquid	mm (inch)	9.52 (3/8)	12.7 (1/2)	15.88 (5/8)	15.88 (5/8)	15.88 (5/8)
		Low Pressure	mm (inch)	22.2 (7/8)	28.58 (11/8)	28.58 (11/8)	28.58 (11/8)	28.58 (11/8)
		High Pressure	mm (inch)	19.05 (3/4)	22.2 (7/8)	22.2 (7/8)	22.2 (7/8)	22.2 (7/8)
Power Supply	∅, V, Hz		1, 220-240, 50 1, 220, 60	1, 220-240, 50 1, 220, 60	1, 220-240, 50 1, 220, 60	1, 220-240, 50 1, 220, 60	1, 220-240, 50 1, 220, 60	

Reducers for Indoor Unit and HR Unit

(Unit : mm)

Model	Liquid	High Pressure	Low Pressure
Indoor Unit Reducer			
PRHR023			
PRHR033 PRHR043 PRHR063 PRHR083			

Y BRANCH AND HEADER BRANCH

For refrigerant distribution of indoor units.



Model Name

Refer to specifications

Applied Products

MULTI V S
 MULTI V IV
 MULTI V III, MULTI V PLUS II, MULTI V PLUS
 MULTI V S
 MULTI V WATER IV
 MULTI V WATER II
 MULTI V WATER S

Key Features

- Various Y Branch pipe of different capacities make MULTI V installation much easier.
- Y Branch and header branch for both gas and liquid are provided.
- Insulation material is also provided for covering the branches.

Key Application

Heat Pump System

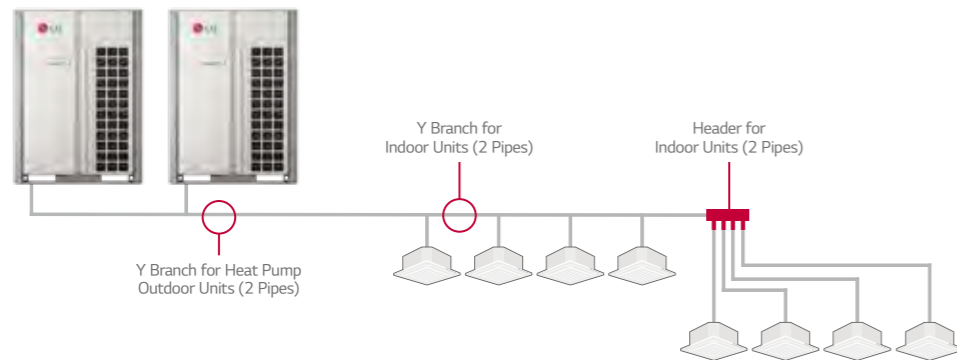

Heat Recovery System

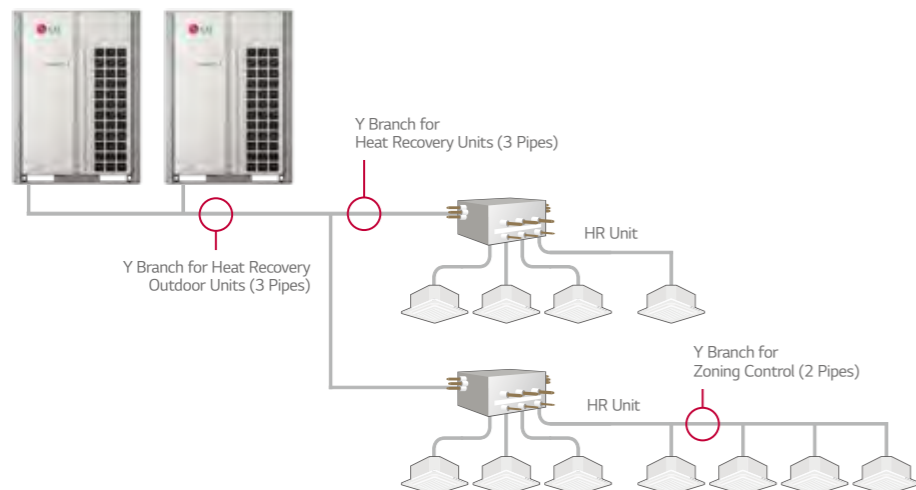

Specification

Header Branch

R410A

(Unit : mm)

Model	Gas Pipe	Liquid Pipe
ARBL054 (4 Branch)		
ARBL057 (7 Branch)		
ARBL104 (4 Branch)		
ARBL107 (7 Branch)		
ARBL1010 (10 Branch)		
ARBL2010 (10 Branch)		

PIPING ACCESSORIES

Y Branch pipe for connection of outdoor units.

Specification

Heat Pump

R410A MULTI V 5, MULTI V IV, MULTI V III, MULTI V WATER IV, MULTI V WATER II

(Unit : mm)

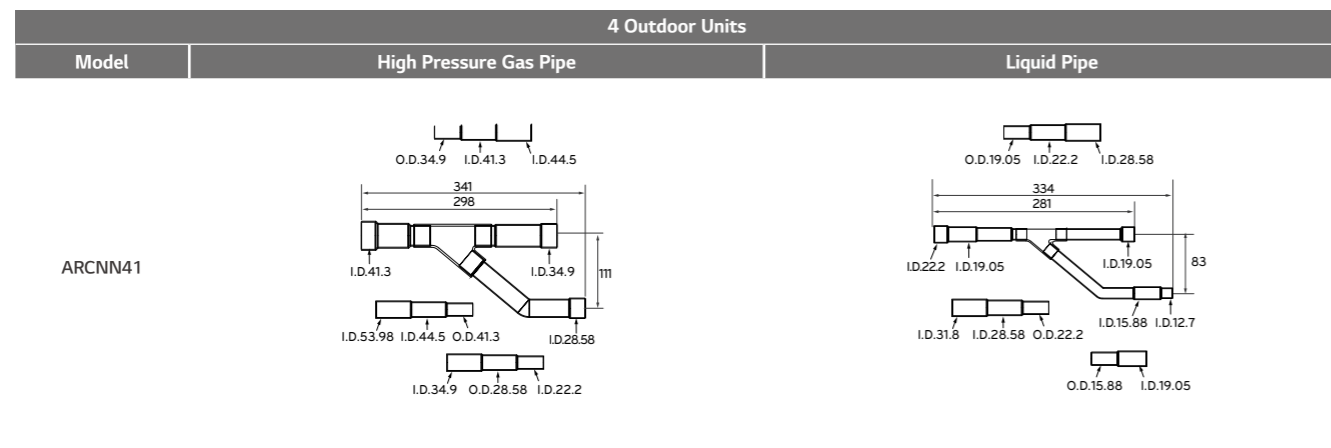
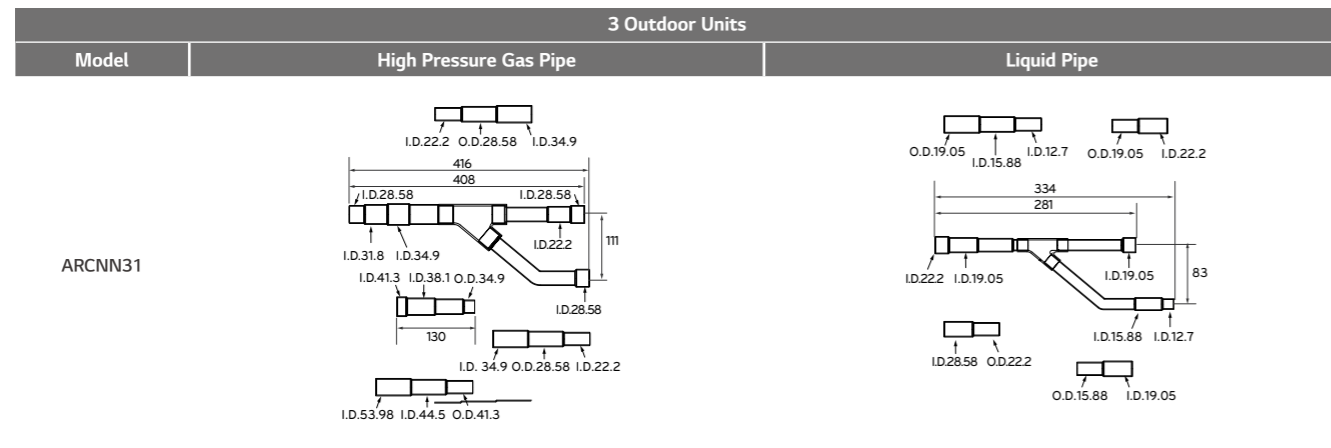
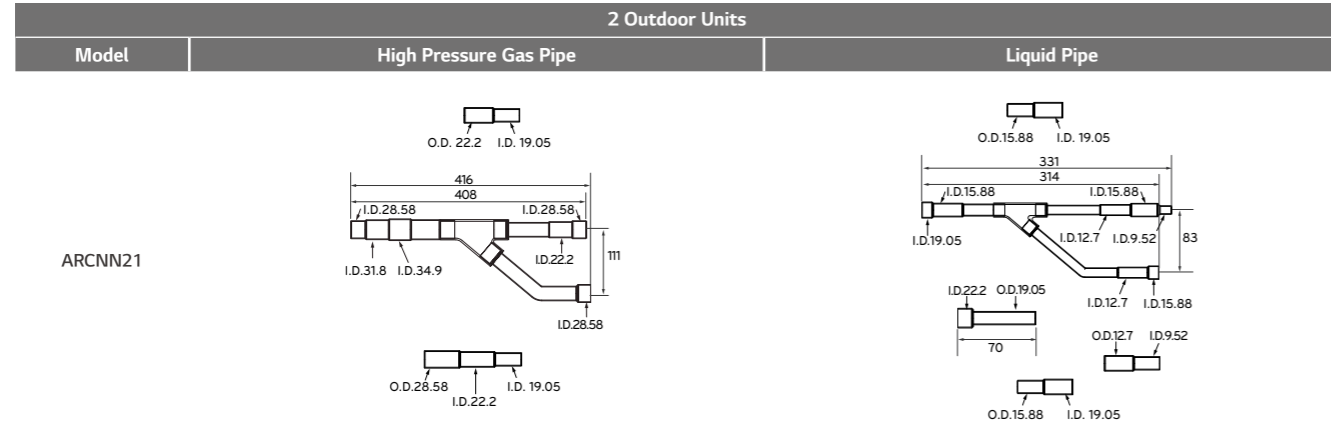

Specification

Heat Recovery

R410A MULTI V 5, MULTI V IV Heat Recovery, MULTI V III Heat Recovery, MULTI V WATER IV Heat Recovery, MULTI V WATER II Heat Recovery

(Unit : mm)

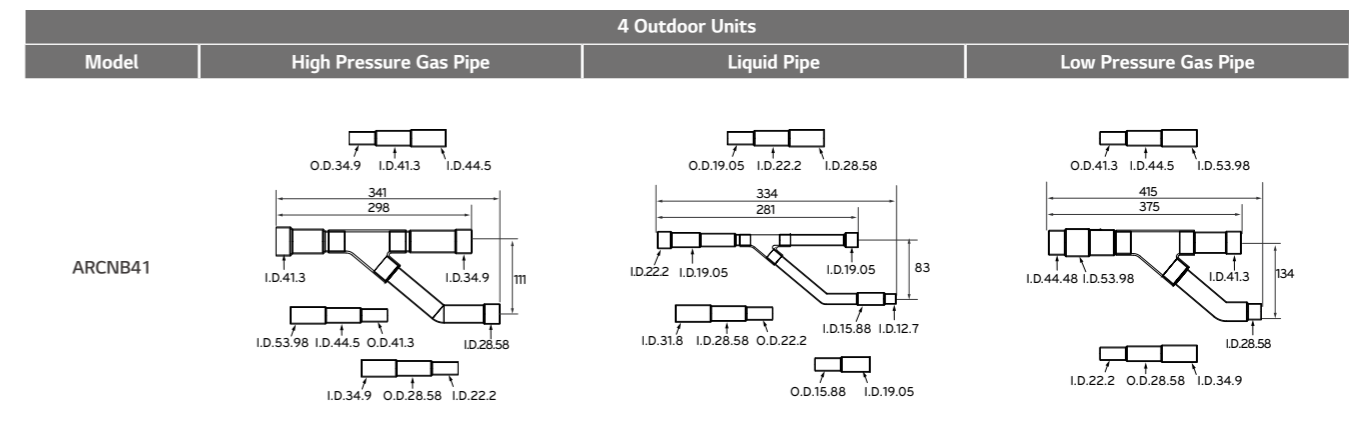
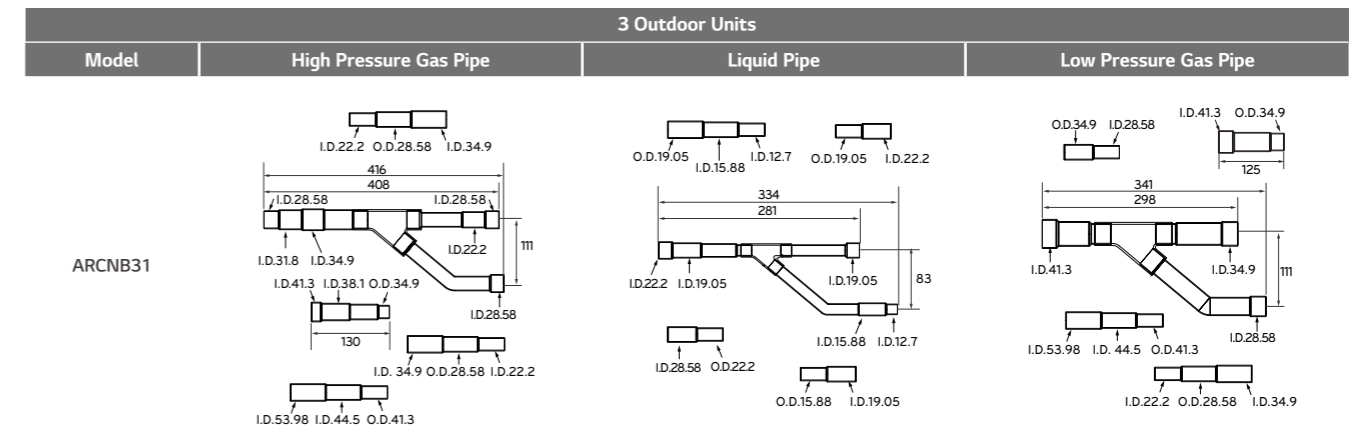
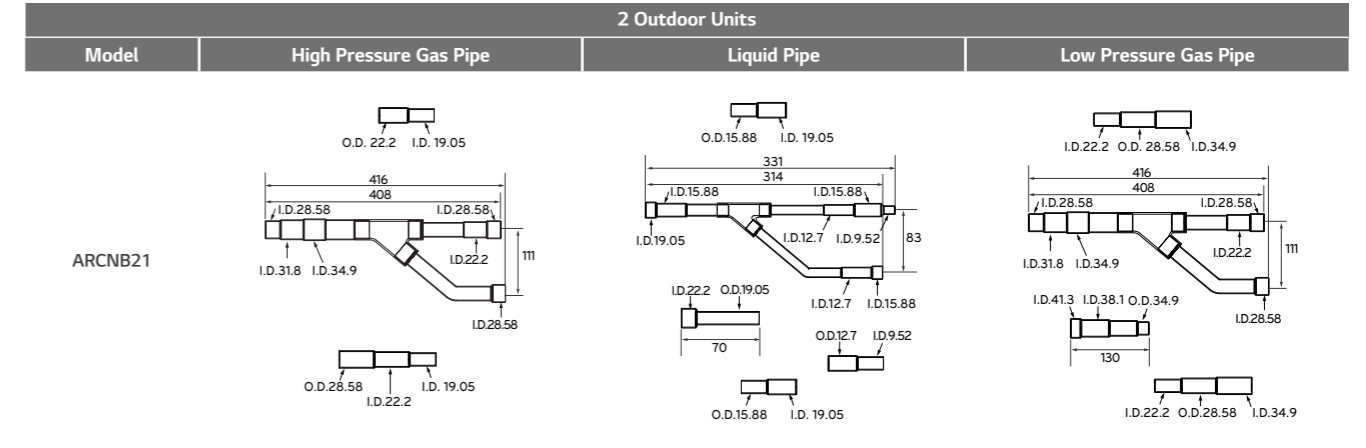

PIPING ACCESSORIES

Y Branch pipe for connection of outdoor units.

Specification

Heat Pump, Heat Recovery Zone Control

R410A MULTI V 5, MULTI V IV, MULTI V III, MULTI V PLUS II, MULTI V PLUS, MULTI V S, MULTI V MINI, MULTI V SPACE II, MULTI V WATER IV, MULTI V WATER S, MULTI V WATER II

(Unit : mm)

Model	Gas Pipe	Liquid Pipe
ARBLN01621		
ARBLN03321		
ARBLN07121		
ARBLN14521		
ARBLN23220		

Specification

Heat Recovery

R410A MULTI V 5, MULTI V IV Heat Recovery, MULTI V III Heat Recovery, MULTI V WATER IV Heat Recovery, MULTI V WATER II Heat Recovery

(Unit : mm)

Model	High Pressure Gas Pipe	Liquid Pipe	Low Pressure Gas Pipe
ARBLB01621			
ARBLB03321			
ARBLB07121			
ARBLB14521			
ARBLB23220			

REFRIGERANT CHARGING KIT

Recharging refrigerant after a pump down or when refrigerant is either insufficient or excessive.



Model Name

PRAC1

Applied Products

MULTI V 5
 MULTI V IV Heat Pump
 MULTI V IV Heat Recovery
 MULTI V III Heat Pump
 MULTI V III Heat Recovery
 MULTI V PLUS II
 MULTI V SYNC II

How to Use

- Arrange manifold, capillary assembly, refrigerant vessel and scale.
- Connect manifold to the gas pipe service valve of outdoor unit as shown in the figure.
- Connect manifold and capillary tube. Use designated capillary assembly only. If designated capillary assembly isn't used, the system may get damaged.
- Connect capillary and refrigerant vessel
- Purge hose and manifold
- After "568" is displayed, open the valve and charge the refrigerant.

Key Application

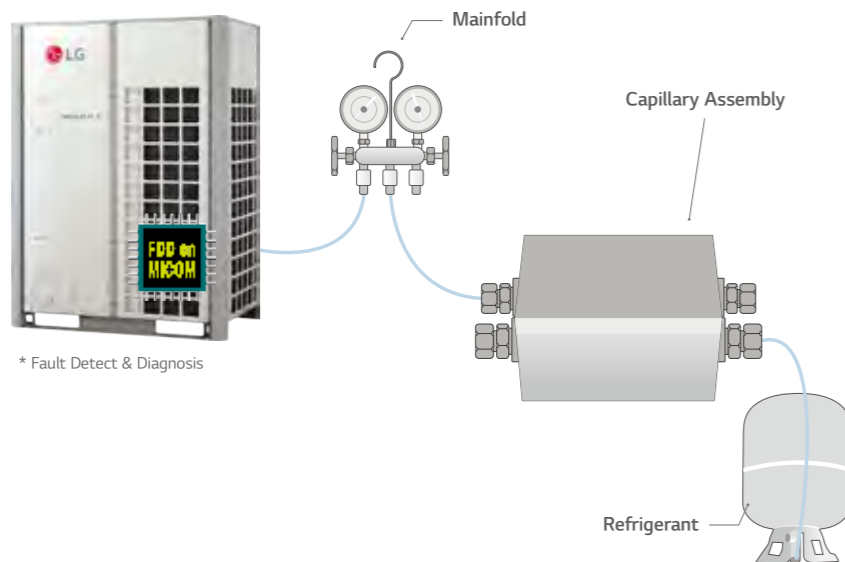

DRAIN HOSE

Easy drain installation.



Model Name

PHDHA05T
 PHDHA07T
 PHDHA05B
 PHDHA07B

Applied Products

MULTI V Indoor units

Key Features

- It reduces the installation time by over 40% with elbow-less drain hose.
- Drain pump covers maximum 700mm high, featuring easy piping installation.

Key Application

- Ceiling Mounted Cassette and Ceiling Concealed Duct. (Refer to PDB for applicable model)

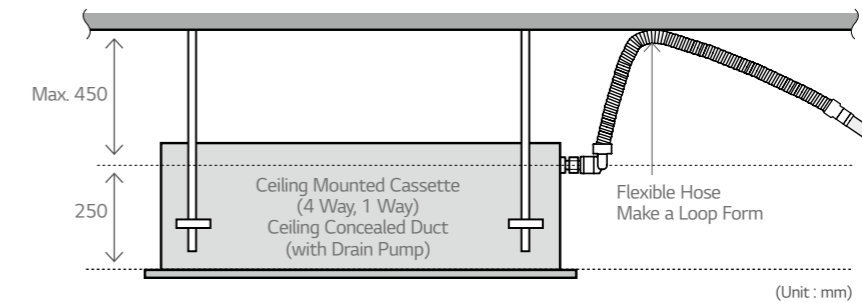

Specification

Model	Length	Quantity
PHDHA05T	500mm	30EA
PHDHA07T	700mm	30EA
PHDHA05B	500mm	5EA
PHDHA07B	700mm	5EA

STOPPER VALVES



Model Name

- PRVT120 (Under 12.7mm)
- PMVT780 (Under 22.2mm)
- PMVT980 (Under 28.58mm)

Key Features

- This unit can be applied for the additional indoor unit's installation.
- This unit can be applied for each indoor unit's service.

Specification

Model	Specification
PRVT120	
PRVT780	
PRVT980	

How to Install

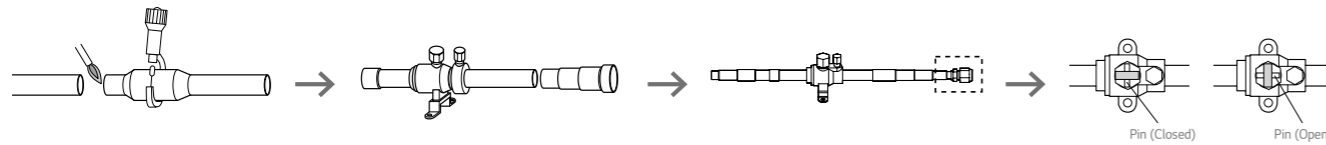

1. Cut the inlet side of the connector, and weld the pipe
2. If installing additional indoor units, the outlet side connector should be cut according to installation pipe.
3. When installing a stopper valve, the flare part should be facing towards additional indoor unit.
4. When installing an additional indoor unit, the SVC valve should be in closed state.

※ When welding, service valve should be wrapped by wet cloth.

Application

(Room 3 & 4 : in use / Room 1 & 2 : need to install indoor units)

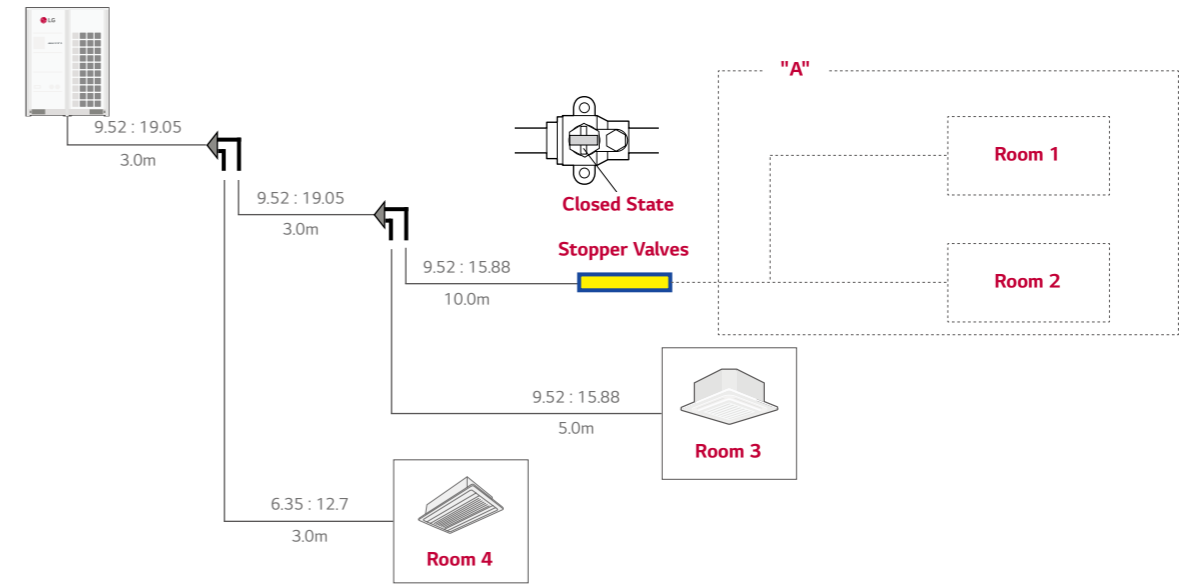

- In case of installation of additional indoor unit, refrigerant of used indoor unit must be discharged. (Room 3 & Room 4)
- If stopper valve is already installed, you can install additional indoor unit without refrigerant loss from the entire system.
- After installation of additional indoor unit, you just need refrigerant charging for "A" section.
- Then, open the Stopper Valve.

